

Since 1913 Acorn Wire + Iron Works™ has been the national leader in folding gates for security, loss prevention, traffic control, school safety, as well as public institution and commercial buildings.

Acorn Gates are compact and easy to operate, and can be adapted to fit most conditions; available in both single and double gate configurations. Offered in different styles our units can come complete with folding top and bottom track systems to create a sturdy blockade from unwanted access as well as accordion across dock door and warehouse areas to protect open doorways from potential accidents and safety hazards.

SURFACE MOUNTED FOLDING GATES

For school, public institution, and traffic control applications; these folding gates can control corridor traffic during hours of operation or special events. Offered in single and double applications fixed gates are available with a deep, shallow, or surface mounted storage cabinet for safe and efficient storage, and can be used in new and retrofit applications.

WAREHOUSE & INDUSTRIAL SAFETY GATES

Offered in a variety of heights and widths; with single and double applications, these gates can expand to cover open dock doors, mezzanine storage areas, and control access to manufacturing areas. These gates can also provide additional exterior protection to warehouse personnel doors. Built to meet the demands of both interior and exterior use these gates will help make your warehouse safe and secure.

RECESSED FOLDING GATES

These heavy-duty gates can be installed anywhere and may be used to bar unwanted pedestrians from entering prohibited or secure areas. All moving parts on our Security Folding Gates are fitted with rollers for smooth operation and stacking when not in use. Units lock in both compressed and extended positions to prevent damage or injury.

PORTABLE FOLDING GATES

Designed specifically for areas where a fixed gate may not be practical. Great for use in new or existing buildings, for temporary barriers or time limited access control. Our Portable Gates may be used in as many different locations as their size allows, their transportable nature creates endless applications.

WARRANTY

Five Year Warranty against defective material and/workmanship.

Construction

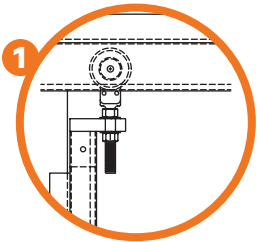
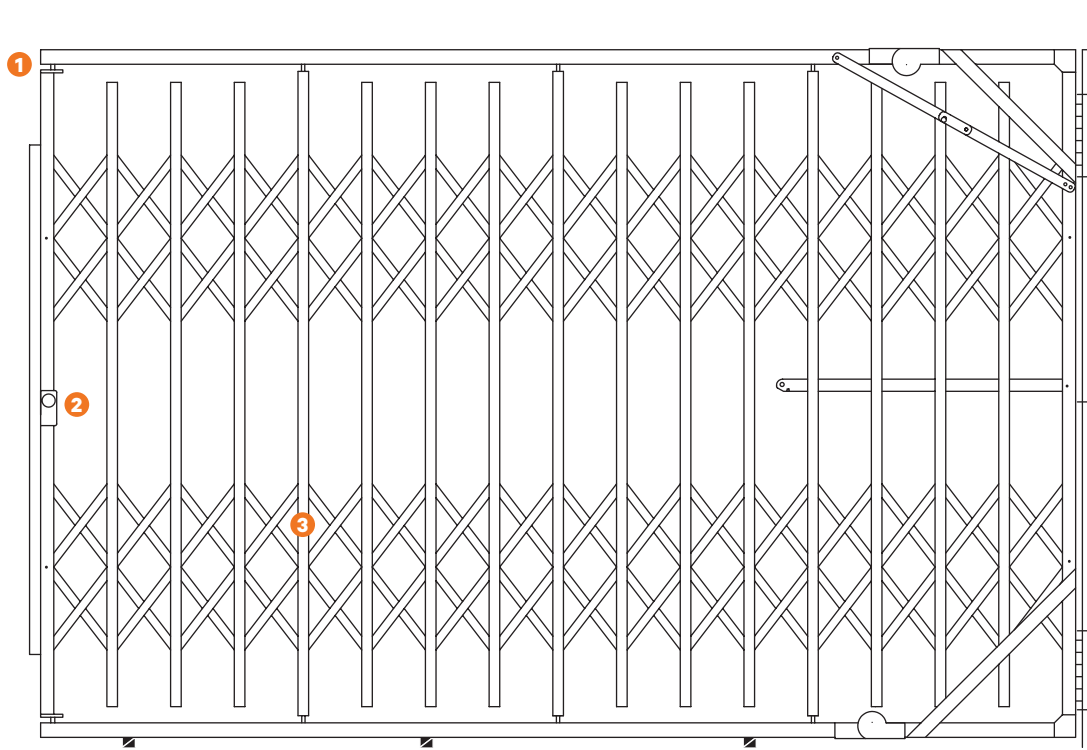

Adjustable ball bearing trucks in box type tracks for smooth operation, 2-wheel trucks on intermediate.

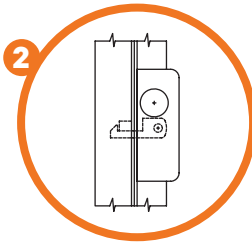

Cylinder locks mortised into gate end bar. Keyed both sides. Yale mortise cylinders, or master-keyed to building system.

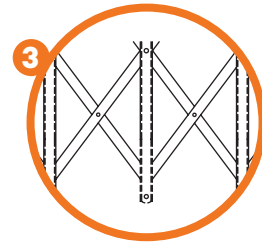

Machined roller bearings in all vertical channels assure ease of operation, proportionate spacing of lattice bars.

SAFETY AND EXIT DEVICE OPTIONS

For School and Fire Code requirements

- Collapsible emergency exit device
- Ohio emergency device
- Wire mesh side panel additions

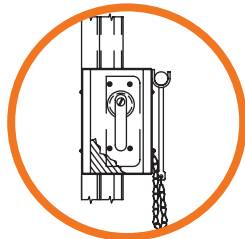
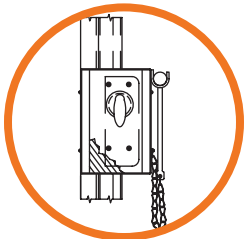

NEW LOCK SYSTEM PRODUCTS

Spec Specific Cylinders and Cores from MOST major manufacturers available.

- Interchangeable core cylinders
- Lock and latch sets
- Exit/Panic devices

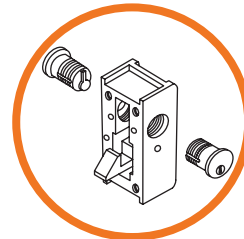
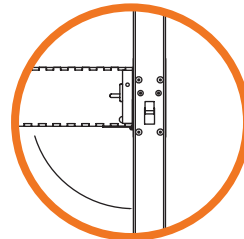

Surface Mounted Folding Gates

USE WHERE RECESSED FEATURES ARE NOT REQUIRED

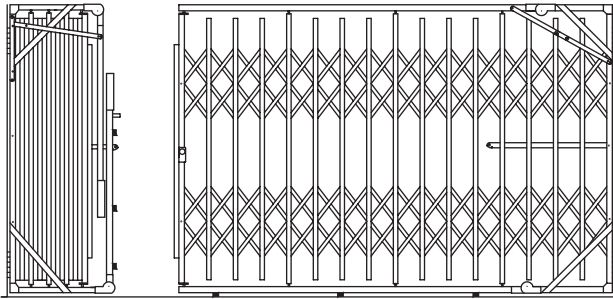

Bostwick | No. 5743D

DOUBLE GATE 20' MAXIMUM WIDTH

- Hinged top and bottom tracks.
- Hasp or cylinder lock. Maximum height 7'6".

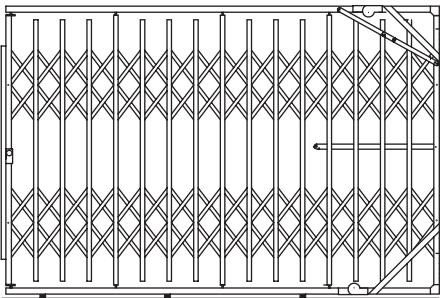

Bostwick | No. 5743S

SINGLE GATE 16' MAXIMUM WIDTH

- Hinged top and bottom tracks.
- Hasp or cylinder lock. Maximum height 7'6".

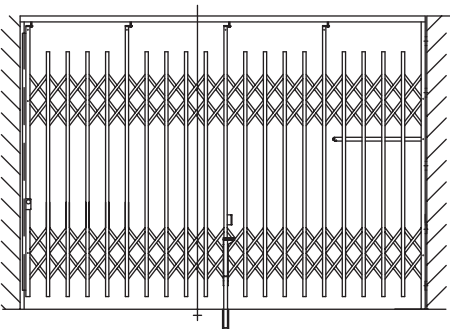

Bostwick | No. 5748

SINGLE GATE 16' MAXIMUM WIDTH

- Hinged top and bottom tracks.
- Hasp or cylinder lock. Maximum height 7'6".
- Fix top track for any height higher than 7'6".

BOSTWICK TECHNICAL SPECS

No. 5743D, No. 5743S & No. 5748

- 0.75" channels spaced vertically not over 6" O.C.
- Lattice bars 0.625" x 0.1875"
- Fully enclosed end bars
- All moving parts fitted with rollers
- All cold-rolled material
- Hasp for padlock or cylinder lock

SPECIFICATIONS ARE SUBJECT TO CHANGE

Please consult your Acorn Sales Rep or visit www.acornwire.com for more details.

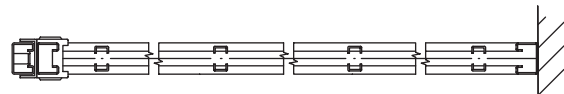
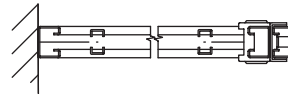

Gate Placement | Plan 2A

- Gates placed in the opening stack fixed in line or flat against the wall.

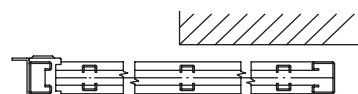
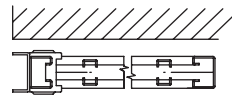

Gate Placement | Plan 2B

- Gates placed on face of wall, stack clear of opening.

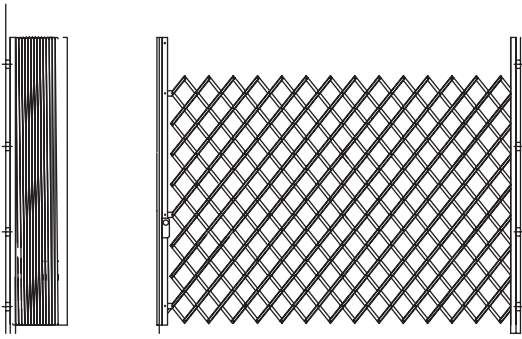

Lazy Tong | No. 5641

DOUBLE GATE 16' MAXIMUM WIDTH

- Hinged or fixed at sides.
- Center-locking floor belt.
- Center extend opening height to fixed top brace where practical.
- Large floor bolt furnished where top brace impractical.

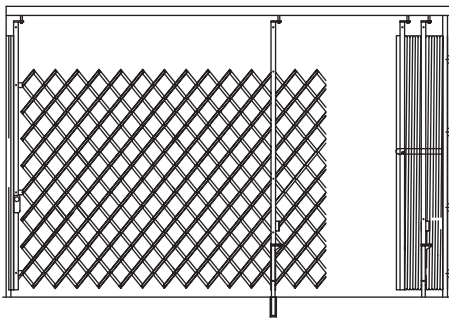

Lazy Tong | No. 5649

SINGLE GATE 12' MAXIMUM WIDTH

- Hinged or fixed at sides.
- May be used with hasp for padlock or cylinder lock.
- Fix top track.

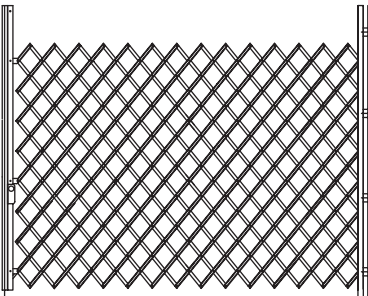

Lazy Tong | No. 5654

SINGLE GATE 12' MAXIMUM WIDTH

- Hinged or fixed at sides.
- May be used with hasp for padlock or cylinder lock.

LAZY TONG TECHNICAL SPECS

Gate loses 1.5" per foot in height when extended.

No. 5641, No. 5649 & No. 5654

- 0.75" channels riveted back-to-back not over 6" O.C.
- Fully enclosed end bars to receive rollers
- All cold-rolled material
- Hasp for padlock or cylinder lock

SPECIFICATIONS ARE SUBJECT TO CHANGE

Please consult your Acorn Sales Rep or visit www.acornwire.com for more details.

w.w.Cannon, Inc.

Design. Layout. Build. Install.

1-800-442-3061
www.wwcannon.com

Recessed Folding Gates

SINGLE TYPE, HINGED TOP & BOTTOM TRACK

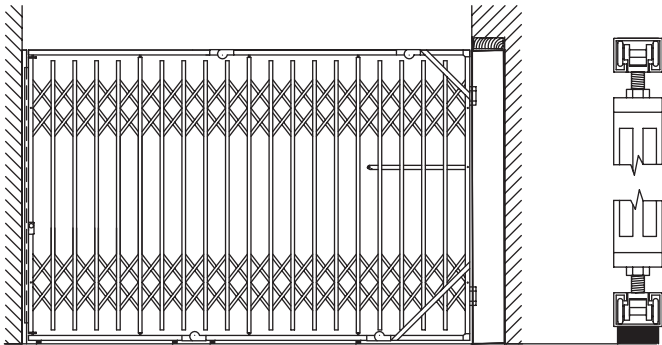

TECHNICAL SPECS

No. 5761S

- Vertical members are two 0.75" x 0.375" cold-rolled channels not spaced over 6" O.C.
- Lattice bars 0.625" x 0.1875" cold-rolled flat steel
- Vertical end bars are cold-rolled box type sections to receive roller bearings and cylinder lock
- All moving parts fitted with rollers
- Hinged top and bottom tracks have gusset braces in all corners, fixed support for top track, rubber floor rests for bottom track
- Self-locking tie back arm for gate
- Cabinet constructed of 12-gauge formed sheet steel with 0.1875" thick cold-rolled fascia strips and door
- Gate and cabinet locks 0.46875" diameter 5 pin tumbler mortise cylinders keyed alike, or master-keyed to building system
- Gate and cabinet standard factory finish, color as selected

corridor (feet)	4	6	8	10	12	14	16
recess (inches)	18	21	24	32	35	38	41

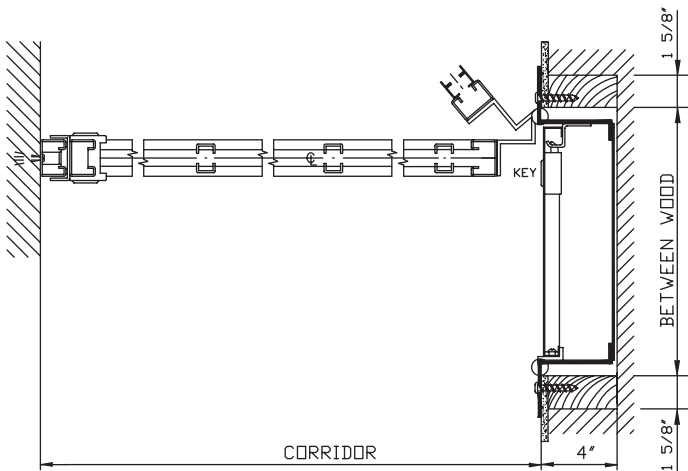

Recess height to be 1" more than gate height

Shallow Cabinet | No. 5761S

SINGLE GATE 16' MAXIMUM CORRIDOR WIDTH

- 7'6" recommended maximum height.
- Roller bearing construction throughout for easy operation.
- All cold-rolled material for better appearance.
- Cabinet door can be closed and locked when gate is in use.
- Cylinder locks on gate and cabinet keyed regular or master-keyed to building system.
- Gates can exceed maximum width but require special recess dimensions.

SPECIFICATIONS ARE SUBJECT TO CHANGE

Please consult your Acorn Sales Rep or visit www.acornwire.com for more details.

w.w.Cannon, Inc.

Design. Layout. Build. Install.

1-800-442-3061
www.wwcannon.com

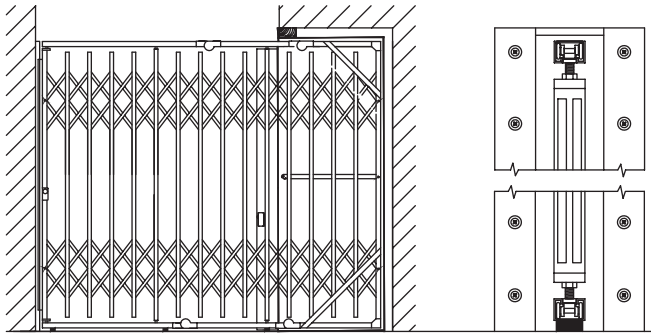

TECHNICAL SPECS

No. 5762S

- Vertical members are two 0.75" x 0.375" cold-rolled channels not spaced over 6" O.C.
- Lattice bars 0.625" x 0.1875" cold-rolled flat steel
- Vertical end bars are cold-rolled box type sections to receive roller bearings and cylinder lock
- All moving parts fitted with rollers
- Hinged top and bottom tracks have gusset braces in all corners, fixed support for top track, rubber floor rests for bottom track
- Self-locking tie back arm for gate
- Cabinet constructed of 12-gauge formed sheet steel with 0.1875" thick cold-rolled fascia strips and door
- Gate and cabinet locks 0.46875" diameter 5 pin tumbler mortise cylinders keyed alike, or master-keyed to building system
- Gate and cabinet standard factory finish, color as selected
- Special hinges on gate permitting cabinet door to close and lock when gate is in both stacked and extended position

corridor (feet)	4	6	8	10	12
recess (inches)	17	20	27	30	33

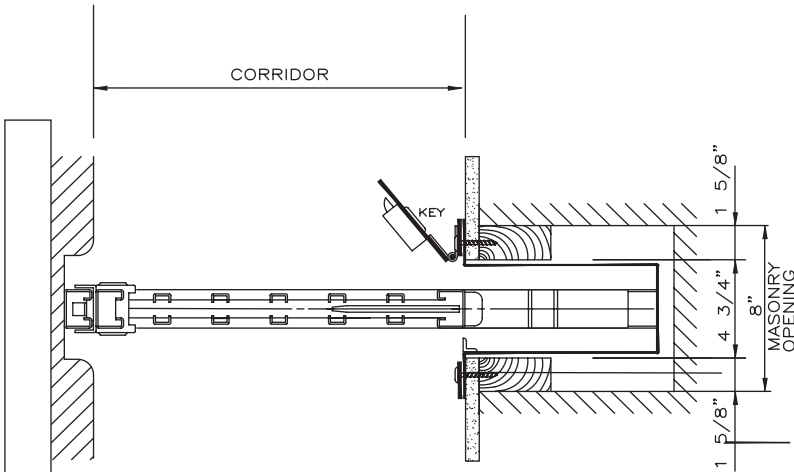

Recess height to be 1" more than gate height

Deep Cabinet | No. 5762S

SINGLE GATE 12' MAXIMUM CORRIDOR WIDTH

- 7'6" recommended maximum height.
- Roller bearing construction throughout for easy operation.
- All cold-rolled material for better appearance.
- Cylinder locks on gate and cabinet keyed regular or master-keyed to building system.
- Gates can exceed maximum width but require special recess dimensions.

SPECIFICATIONS ARE SUBJECT TO CHANGE

Please consult your Acorn Sales Rep or visit www.acornwire.com for more details.

Recessed Folding Gates

DOUBLE TYPE, HINGED TOP & BOTTOM TRACK

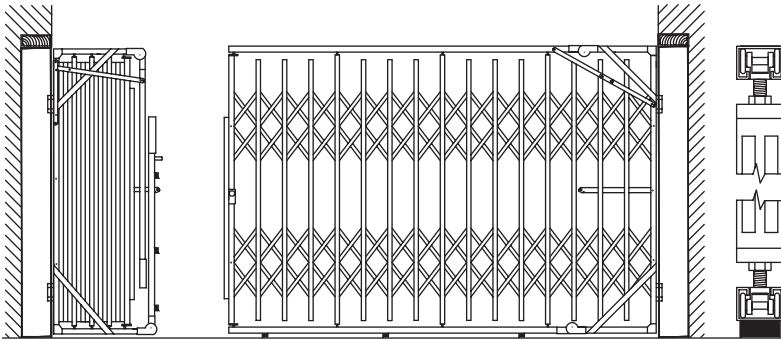

TECHNICAL SPECS

No. 5761D

- Vertical members are two 0.75" x 0.375" cold-rolled channels not spaced over 6" O.C.
- Lattice bars 0.625" x 0.1875" cold-rolled flat steel
- Vertical end bars cold-rolled box type sections to receive roller bearings and cylinder lock
- All moving parts fitted with rollers
- Hinged top and bottom tracks have gusset braces in all corners, automatic hold up arms for top tracks, rubber floor rests for bottom tracks
- Self-locking tie back arms for gate
- Cabinet constructed of 0.1875" cold-rolled Z bar frames with 16-gauge steel backs
- Formed 'C' edges on flush 16-gauge door
- Special hinges on gate permitting cabinet doors to close and lock when gate is in both stacked and extended position
- Gate and cabinet locks 0.46875" diameter 5 pin tumbler mortise cylinders keyed alike, or master-keyed to building system
- Gate and cabinet standard factory finish, color as selected

corridor (feet)	10	12	14	16	18	20
recess (inches)	20.5	22	23.5	27.5	30.25	32

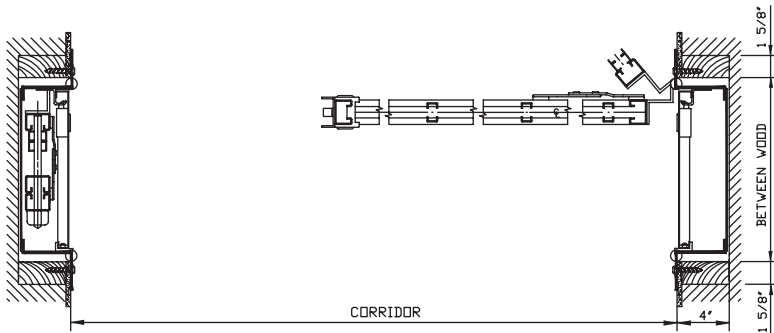

Recess height to be 1" more than gate height

Shallow Cabinet | No. 5761D

DOUBLE GATE 20' MAXIMUM CORRIDOR WIDTH

- 7'6" recommended maximum height.
- Roller bearing construction throughout for easy operation.
- All cold-rolled material for better appearance.
- Cabinet door can be closed and locked when gate is in use.
- Cylinder locks on gate and cabinets keyed regular or master-keyed to building system.
- Gates can exceed maximum width but require special recess dimensions.

SPECIFICATIONS ARE SUBJECT TO CHANGE

Please consult your Acorn Sales Rep or visit www.acornwire.com for more details.

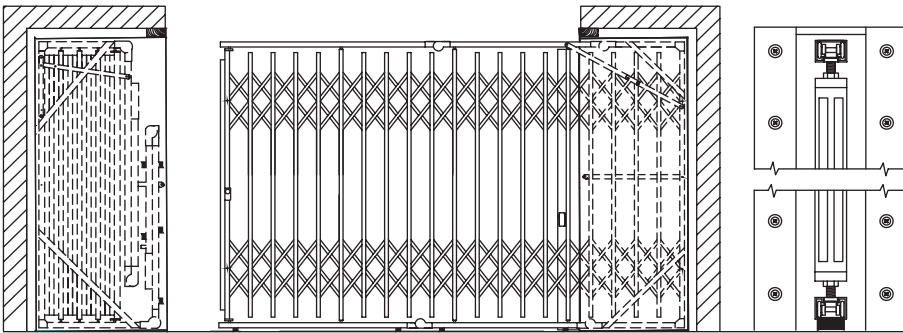

TECHNICAL SPECS

No. 5762D

- Vertical members are two 0.75" x 0.375" cold-rolled channels not spaced over 6" O.C.
- Lattice bars 0.625" x 0.1875" cold-rolled flat steel
- Vertical end bars are cold-rolled box type sections to receive roller bearings and cylinder lock
- All moving parts fitted with rollers
- Hinged top and bottom tracks have gusset braces in all corners, automatic hold up arms for top tracks, rubber floor rests for bottom tracks
- Self-locking tie back arms for gate
- Cabinets constructed of 12-gauge formed sheet steel with 0.1875" thick cold-rolled fascia strips and door
- Gate and cabinet locks 0.46875" diameter 5 pin tumbler mortise cylinders keyed alike, or master-keyed to building system
- Gate and cabinet standard factory finish, color as selected

corridor (feet)	10	12	14	16	18	20
recess (inches)	20	25	27	28	30	31

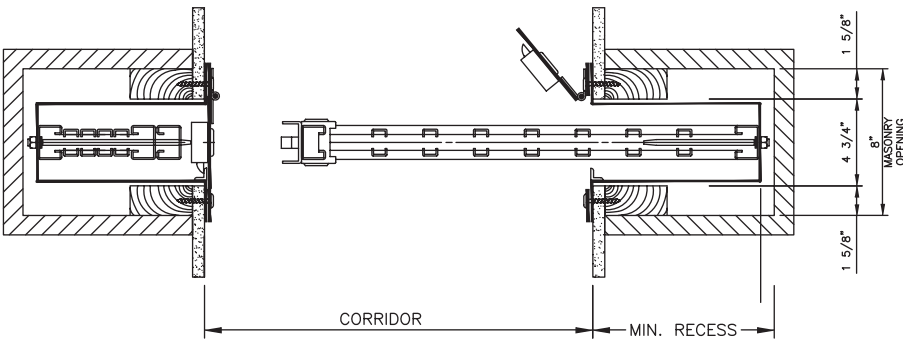

Recess height to be 1" more than gate height

Deep Cabinet | No. 5762D

DOUBLE GATE 20' MAXIMUM CORRIDOR WIDTH

- 7'6" recommended maximum height.
- Roller bearing construction throughout for easy operation.
- All cold-rolled material for better appearance.
- Cylinder locks on gate and cabinets keyed regular or master-keyed to building system.
- Gates can exceed maximum width but require special recess dimensions.

**SPECIFICATIONS ARE
SUBJECT TO CHANGE**

**Please consult your Acorn
Sales Rep or visit**

**www.acornwire.com
for more details.**

Recessed Folding Gates

SINGLE TYPE, PERMANENT TOP GUIDE & HINGED BOTTOM TRACK

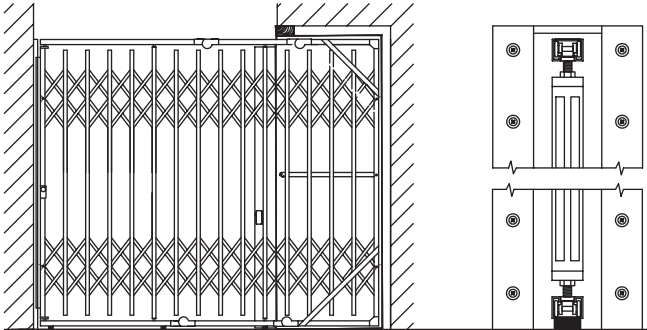

TECHNICAL SPECS

No. 5765S

- Vertical members are two 0.75" x 0.375" cold-rolled channels not spaced over 6" O.C.
- Lattice bars 0.625" x 0.1875" cold-rolled flat steel
- Vertical end bars are cold-rolled box type sections to receive roller bearings and cylinder lock
- All moving parts fitted with rollers
- Top guide 10-gauge channel recessed into ceiling, bottom track has gusset braces and rubber floor rests
- Self-locking tie back arms for gate
- Cabinet constructed of 12-gauge formed sheet steel with 0.1875" thick cold-rolled fascia strips and door
- Gate and cabinet locks 0.46875" diameter 5 pin tumbler mortise cylinders keyed alike, or master-keyed to building system
- Gate and cabinet standard factory finish, color as selected

corridor (feet)	6	8	10	12	14
recess (inches)	19	25	25.5	28.5	31.5

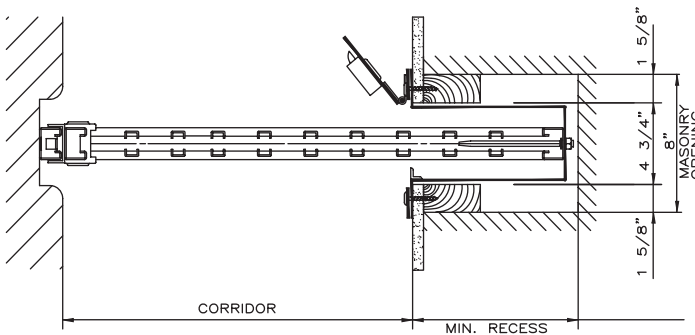

Recess height to be 1" more than gate height

Deep Cabinet | No. 5765S

SINGLE GATE UNLIMITED WIDTH

- Full opening height over 8' and 3 row lattice.
- Roller bearing construction throughout for easy operation.
- All cold-rolled material for better appearance.
- Cylinder locks on gate and cabinet keyed regular or master-keyed to building system.
- Gate can be hung from permanent top track if suitable support is present.

SPECIFICATIONS ARE SUBJECT TO CHANGE

Please consult your Acorn Sales Rep or visit www.acornwire.com for more details.

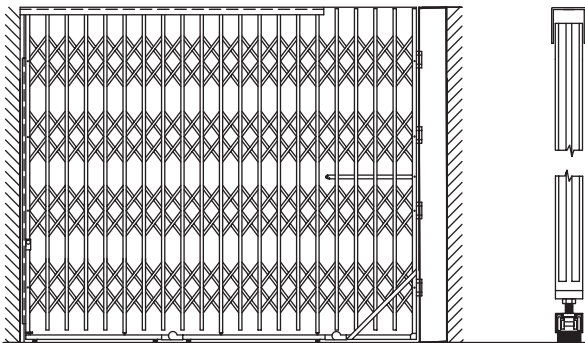

corridor (feet)	8	10	12	14	16	18	20
recess (inches)	22.5	28.5	31.5	34.5	37.75	40.75	44

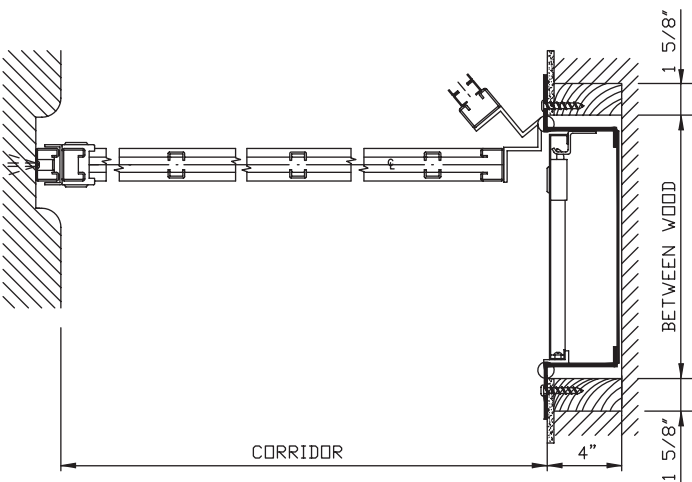

Recess height to be 1" more than gate height

Shallow Cabinet | No. 5766S

SINGLE GATE 20' MAXIMUM CORRIDOR WIDTH

- Full opening height over 8' and 3 row lattice.
- Roller bearing construction throughout for easy operation.
- All cold-rolled material for better appearance.
- Cabinet door can be closed and locked when gate is in use.
- Cylinder locks on gate and cabinet keyed regular or master-keyed to building system.
- Gates can exceed maximum width but require special recess dimensions.

TECHNICAL SPECS

No. 5766S

- Vertical members are two 0.75" x 0.375" cold-rolled channels not spaced over 6" O.C.
- Lattice bars 0.625" x 0.1875" cold-rolled flat steel
- Vertical end bars are cold-rolled box type sections to receive roller bearings and cylinder lock
- All moving parts fitted with rollers
- Top guide 2.375" x 2.25" channel, bottom track has gusset braces and rubber floor rests
- Self-locking tie back arm for gate
- Cabinet constructed of 0.1875" thick cold-rolled Z bar frame with 16-gauge steel back
- Formed 'C' edges on flush 16-gauge door
- Gate equipped with special hinges permitting cabinet door to close and lock when gate is both stacked or extended
- Gate and cabinet locks 0.46875" diameter 5 pin tumbler mortise cylinders keyed alike, or master-keyed to building system
- Gate and cabinet standard factory finish, color as selected

SPECIFICATIONS ARE SUBJECT TO CHANGE

Please consult your Acorn Sales Rep or visit www.acornwire.com for more details.

Recessed Folding Gates

DOUBLE TYPE, PERMANENT TOP GUIDE & HINGED BOTTOM TRACK

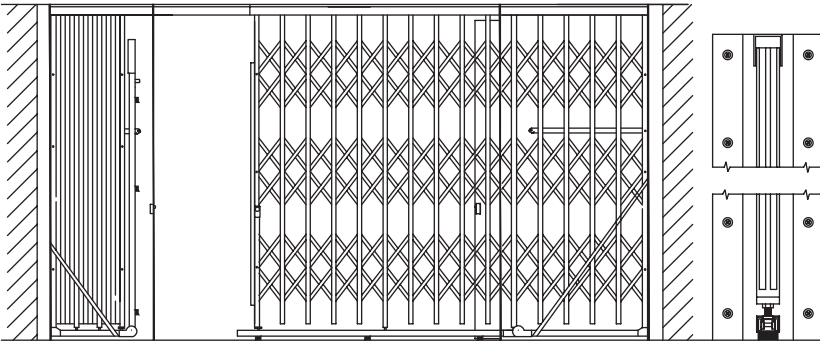

TECHNICAL SPECS

No. 5765D

- Vertical members are two 0.75" x 0.375" cold-rolled channels not spaced over 6" O.C.
- Lattice bars 0.625" x 0.1875" cold-rolled flat steel
- Vertical end bars are cold-rolled box type sections to receive roller bearings and cylinder lock
- All moving parts fitted with rollers
- Top guide 10-gauge channel recessed into ceiling, bottom tracks have gusset braces and rubber floor rests
- Self-locking tie back arms for gate
- Cabinet constructed of 12-gauge formed sheet steel with 0.1875" thick cold-rolled fascia strips and doors
- Gate and cabinet locks 0.46875" diameter 5 pin tumbler mortise cylinders keyed alike, or master-keyed to building system
- Gate and cabinets standard factory finish, color as selected

corridor (feet)	10	12	14	16	18	20	22	24
recess (inches)	17	19	20.5	34.75	25.5	26.25	27	28.5

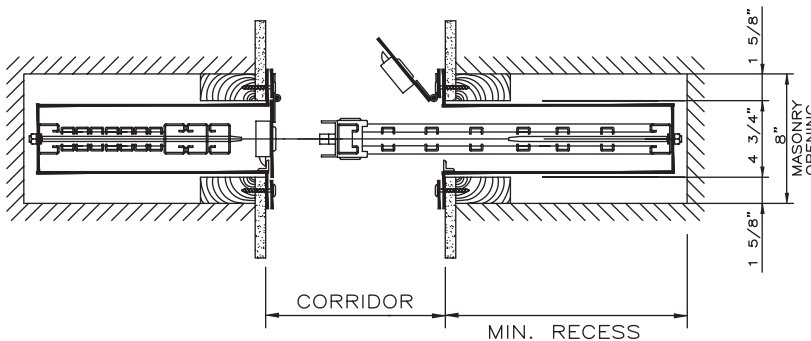

Recess height to be 1" more than gate height

Deep Cabinet | No. 5765D

DOUBLE GATE UNLIMITED WIDTH

- Full opening height over 8' and 3 row lattice.
- Roller bearing construction throughout for easy operation.
- All cold-rolled material for better appearance.
- Cylinder locks on gate and cabinets keyed regular or master-keyed to building system.
- Gate can be hung from permanent top track if suitable support is present.

SPECIFICATIONS ARE SUBJECT TO CHANGE

Please consult your Acorn Sales Rep or visit www.acornwire.com for more details.

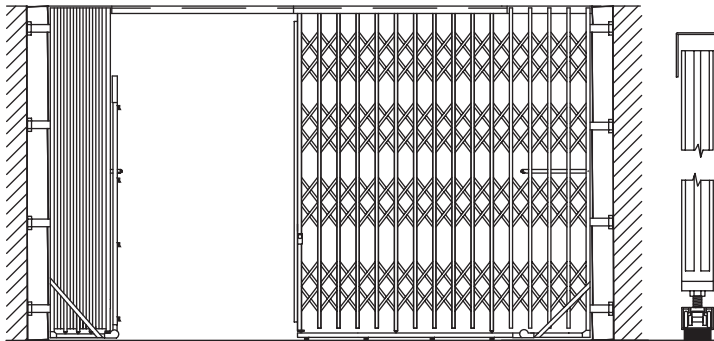

TECHNICAL SPECS

No. 5766D

- Vertical members are two 0.75" x 0.375" cold-rolled channels not spaced over 6" O.C.
- Lattice bars 0.625" x 0.1875" cold-rolled flat steel
- Vertical end bars are cold-rolled box type sections to receive roller bearings and cylinder lock
- All moving parts fitted with rollers
- Top guide 2.375" x 2.25" channel, bottom track has gusset braces in all corners and rubber floor rests
- Self-locking tie back arm for gate
- Cabinet constructed of 0.1875" thick cold-rolled Z bar frames with 16-gauge steel backs
- Formed 'C' edges on flush 16-gauge door
- Gate equipped with special hinges permitting cabinet doors to close and lock when gate is both stacked or extended
- Gate and cabinet locks 0.46875" diameter 5 pin tumbler mortise cylinders keyed alike, or master-keyed to building system
- Gate and cabinets standard factory finish, color as selected

corridor (feet)	10	12	14	16	18	20
recess (inches)	18	19.5	21	22.5	36.75	28.5

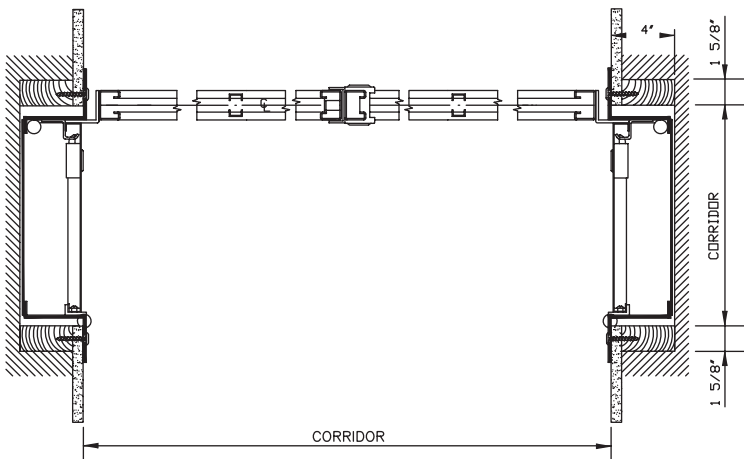

Recess height to be 1" more than gate height

Shallow Cabinet | No. 5766D

DOUBLE GATE 40' MAXIMUM CORRIDOR WIDTH

- Full opening height over 8' and 3 row lattice.
- Roller bearing construction throughout for easy operation.
- All cold-rolled material for better appearance.
- Cabinet door can be closed and locked when gate is in use.
- Cylinder locks on gate and cabinets keyed regular or master-keyed to building system.
- Gates can exceed maximum width but require special recess dimensions.

SPECIFICATIONS ARE SUBJECT TO CHANGE

Please consult your Acorn Sales Rep or visit www.acornwire.com for more details.

Portable Folding Gates

USE WITH ANY 7' TO 12' CORRIDOR WIDTH

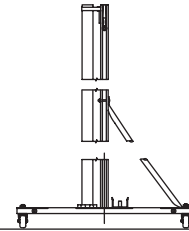
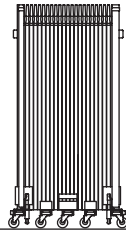
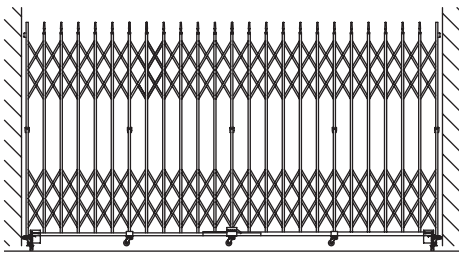

Bostwick | No. 57P

12' MAXIMUM WIDTH

- Standard model can be used in any corridor from 7'-12' wide.
- Standard model stored unit 2' x 2'-6" x 6'-6.5" high.
- Height permits storage in any closet.
- Heavy electro-galvanized finish is standard.
- Distance between lattice bars plus spear tops on gate prevent climbing.
- Only two lead shields are required in floor for installation at each location.
- No preparation of wall or floor is necessary.
- Gate available with hasp for padlock, or cylinder lock.
- Other stock sizes range from 6', 9', 11', 13', 14', 15', 18' and 21'.
- For large span applications multiple gates can be linked together.

TECHNICAL SPECS

No. 57P

- Vertical members are two 0.75" x 0.375" cold-rolled channels not spaced over 6" O.C.
- Lattice bars 0.625" x 0.1875" cold-rolled flat steel
- All moving parts fitted with rollers
- Platform frames 2.25" x 1" cold-rolled channel
- Platform braces 0.875", 14-gauge tubing, securely bolted through gate and platform
- All material electro-galvanized
- Gate equipped with hasp for padlock or cylinder lock



SPECIFICATIONS ARE SUBJECT TO CHANGE

Please consult your Acorn Sales Rep or visit www.acornwire.com for more details.

Color Options

Customize your Wire Mesh Partitions to match existing color schemes within your facility. Custom color powder coat finishes are available for all Acorn Folding Gates with an additional lead time.

Below is a collection of our standard powder coat colors*. Contact us for a color consultation or samples. Premium Price applies for white & yellow only.



White



Almond



Tower Gray



Black



Walnut Brown



Rain Forest



Deck Red



Safety Red



Safety Blue



Safety Yellow



** Colors shown in print may not be an exact representation of the true product color.*

PRODUCTS CAN ALSO BE:

HOT DIP GALVANIZED

ELECTRO GALVANIZED

ELECTRO GALVANIZED + POWDER COATED



**QUALITY
VALUE
EXPERTISE
ON TIME
ECO-FRIENDLY
CUSTOM
SINCE 1913**



w.w.Cannon, Inc.

Design. Layout. Build. Install.

1-800-442-3061
www.wwcannon.com