

PIONEER

SL SERIES (NON-CLUTCH MECHANISM)

CSL SERIES (CLUTCH MECHANISM)

OPTIONAL THRU BOLT INSTALLATION

Meets ADA requirements
Specially designed for
Barrier Free Application
Conforms with ANSI A156.2
Series 4000, Grade 2
Exceeds 400,000 cycles

Optional tactile warning
meets handicap and fire code

Push in and
turn button function

Coil compression
springs provide great
strength and durability

UL LISTED 3 HOUR RATED
1/2" Throw deadlatch completely
reversible for flat & beveled doors

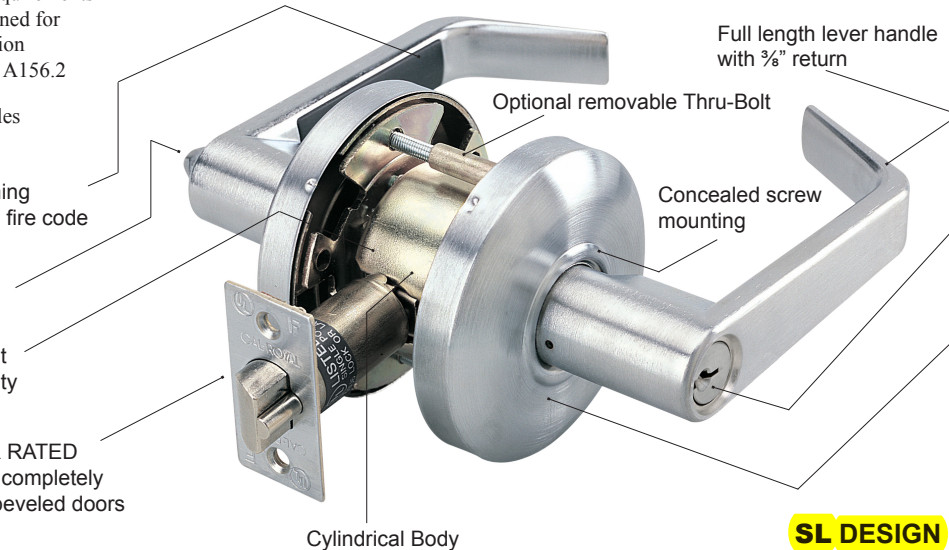

Solid brass 6 pin "C"
keyway cylinder.

Available with Small Format
Interchangeable Core

Individual spring on each
side to prevent lever sag,
maintain reliability and reduce
maintenance



AG DESIGN

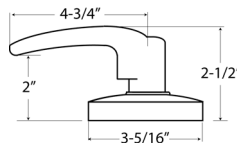

SL DESIGN



RL DESIGN

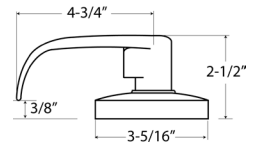
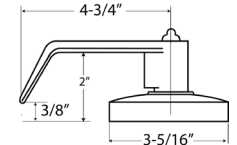

SPECIFICATIONS

APPLICATIONS

For offices, schools, hospitals, apartments, hotel / motel, residential, commercial and public buildings.

DOOR RANGES

1 3/8" to 1 3/4" thickness doors.

BACKSET

2 3/4" Standard, 2 3/8", 3 3/4" and 5" optional.

LATCH BOLT

1/2" Throw solid brass, reversible for RH or LH applications. UL Listed.

LATCH FACEPLATE

2 1/4" x 1 1/8", adjustable for flat or beveled doors 1/8" in 2", for 2 3/4" backset.
Optional 2 1/4" x 1" for 2 3/8" backset.

ANSI STANDARDS

Meets or exceeds requirements of BHMA / ANSI A156.2 Series 4000, Grade 2 (FF-H 106C), 400,000 cycles.

EXPOSED TRIM

Wrought brass, bronze or stainless steel, levers are Zinc casting, plated to match trim finish.

KEYING

6-pin "C" keyway cylinder, 2 keys per lock. Keying as per individual job requirement.

CYLINDER & KEYWAYS

6 pin solid brass "C" keyway standard. Schlage E, Schlage C-K, Russwin D1-2-3-4, Corbin 59 / 60, Corbin-Russwin L4, Sargent LA-LB-LC, Falcon / Weiser E, Arrow A, Yale 8, Yale GA and Kwikset. Can also accept Medeco, Assa, Kaba and Cal-Royal (HSK) High Security Cylinders.

CLUTCH

Clutch available on all keyed locks and privacy functions. Prefix "C" before part number.

INTERCHANGEABLE CORE

Interchangeable Core locks will accept compatible 6 or 7 pin cores with BEST, FALCON and ARROW. Prefix "IC" before part number. Available combined or uncombined. Temporary construction cores available. Factory keying with control key and master key available.

STRIKES

ASA strike standard, "T" and full lip strike available on request.

TACTILE & LEAD LINING available upon request.

PIONEER SL SERIES FINISHES AND FUNCTIONS



FINISHES AVAILABLE		
BHMA SYMBOL	US CODE	DESCRIPTION
605	US3	Polished Brass
606	US4	Satin Brass
609	US5	Antique Brass
612	US10	Satin Bronze
613	US10BE	Dark Oxidized Satin Bronze, Equivalent
619	US15	Satin Nickel
625	US26	Polished Chrome
626	US26D	Satin Chrome

Refer to price list for stock finishes and functions

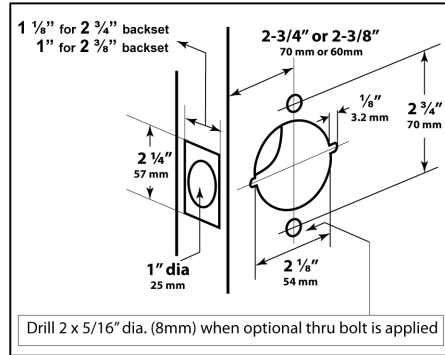

DOOR PREPARATION



LIFETIME WARRANTY



BHMA CERTIFIED
Be Safe. Be Secure. Look for the Mark.

UL US
3 HOUR FIRE RATED
UL10C, UBC7-2-1997

SL00
 **ICSL00**
 **CSL00**
 ANSI: F109

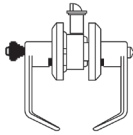
ENTRANCE / OFFICE LOCK
Turn / Push button locking. Pushing and turning button locks outside lever requiring use of key until button is manually unlocked. Pushing button locks outside lever until unlocked with key or inside lever is turned.



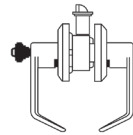

SL101
 **ICSL101**
 **CSL101**
 ANSI: F90

DORMITORY / ASSISTED LIVING
Deadlocking latch bolt operated by lever from either side except when outside lever is locked by key or by push button on inside lever. Key in outside lever locks or unlocks outside lever. Outside key releases push button when locked from inside. Rotating inside lever or closing the door releases push button.



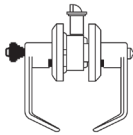

COMBINATION ENTRANCE / OFFICE LOCK AND SINGLE CYLINDER DEADBOLT -- KA / 2 PACKED TOGETHER
Turn / Push button locking. Pushing and turning button locks outside lever requiring use of key until button is manually unlocked. Pushing button locks outside lever until unlocked with key or inside lever is turned. Dead locking latch bolt retracted by key from outside or by thumb turn on inside. Adjustable 2 3/8" or 2 3/4" backset.



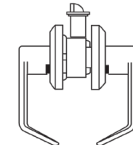

SL10
 **CSL10**
 ANSI: F77

PATIO
Deadlocking latch bolt operated by lever from either side. Outside lever is locked by push button inside and unlocked by rotating inside lever or closing door.



SL00/T220

SL01
 **ICSL01**
 **CSL01**
 ANSI: F82

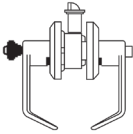

ENTRANCE LOCK PUSH BUTTON
Pushing button in inside lever locks outside lever. Turning inside lever or operating key in outside lever releases button automatically. Closing door does not release button. Button cannot be fixed in lock position. Inside lever always free. Latch bolt automatically deadlocks when door is closed.

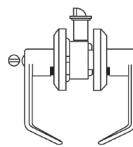

SL20
 **CSL20**
 ANSI: F76

PRIVACY LOCK
Latch bolt operated by lever from either side. Outside lever is locked by push button inside and unlocked by emergency release outside. Turning inside lever or closing door releases push button.



SL03
 **ICSL03**
 **CSL03**
 ANSI: F84

CLASSROOM LOCK
Dead locking latch bolt operated by lever from either side except when outside lever is locked from outside by key. When outside lever is locked, latch bolt is operated by turning inside lever.

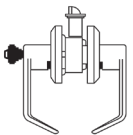

SL30
 **CSL30**
 ANSI: F75

PASSAGE SET
Latch bolt operated by lever from either side at all times.

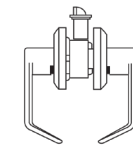

SL05
 **ICSL05**
 **CSL05**
 ANSI: F86

STOREROOM LOCK
Dead locking latch bolt operated by key in outside lever or by rotating inside lever. Outside lever is always fixed.

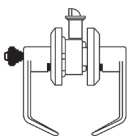

SL40

DUMMY LEVER
Single dummy trim for one side of door. Pull only.

SL80
 **ICSL80**
 **CSL80**
 ANSI: F89

EXIT LOCK
CONNECTING ROOM WITH KEY
Deadlocking latch bolt operated with key from inside only. Blank plate outside.

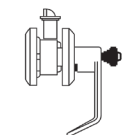

SL50
 **CSL50**
 ANSI: F89

EXIT LOCK
Blank plate outside. Inside lever always unlocked.

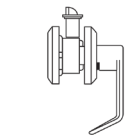

• "IC" Indicates function available with BEST, FALCON & ARROW Interchangeable Core.
 • "CSL" Indicates function available with clutch
OTHER FUNCTIONS NOT LISTED AVAILABLE UPON REQUEST

HOW TO ORDER:
 For "AG" or "RL" designs, replace design name.
 Example: SL00 entrance in "AG" is AG00.