

3" Touchscreen Wall Control (P/N: 74224)

Basic Wall Control (P/N: 78240)

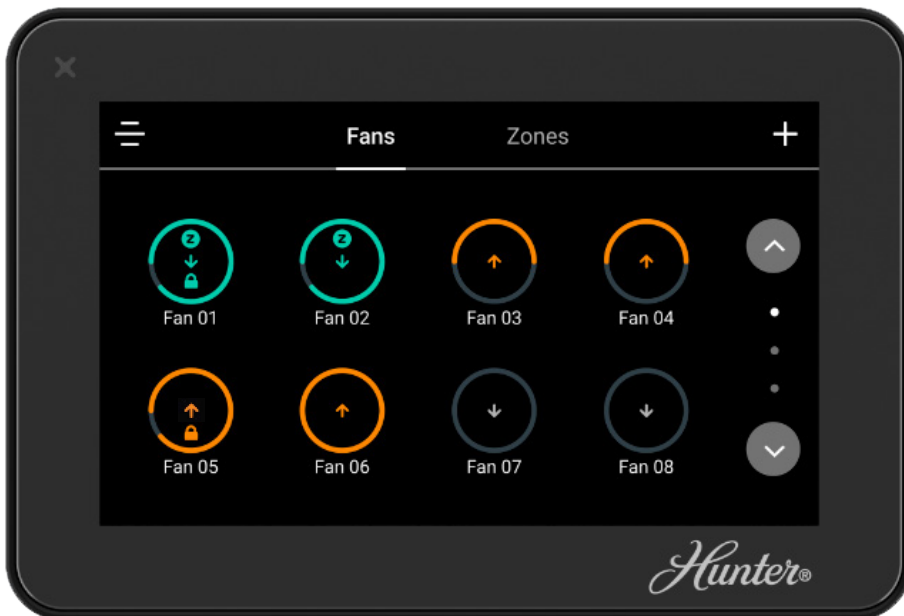

4" Touchscreen Wall Control (P/N: 74225)

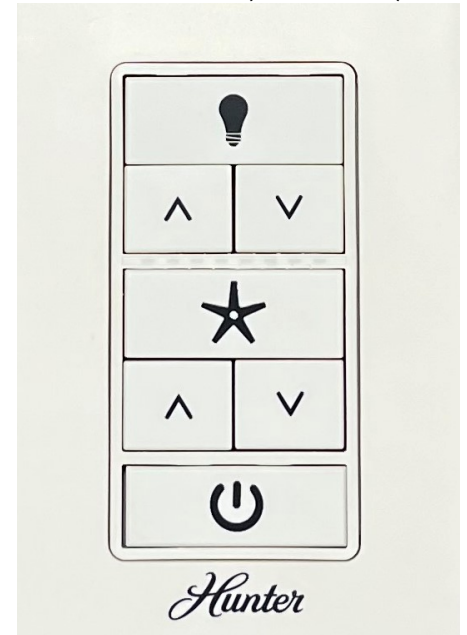

BASIC WALL CONTROL
 3" TOUCHSCREEN WALL CONTROL
 4" TOUCHSCREEN WALL CONTROL

COMMERCIAL
 WIRED WALL
 CONTROLS

USER MANUAL

CONTENTS

3-7 **ICONS**

8-11 **CONTROLLER MOUNTING**

12-21 **BASIC WALL CONTROL AND 3"/4" TOUCHSCREEN WALL
CONTROL SET-UP AND OPERATION**

- Initial Configuration
- Light Configuration
- Operating the Fan or Zone
- Creating and Configuring a Zone
- Scheduling a Fan or a Zone

22 **TROUBLESHOOTING**

23 **ALERT CODES**

w.w.Cannon, Inc.

Design. Layout. Build. Install.

1-800-442-3061

www.wwcannon.com

BASIC WALL CONTROL ICONS



LIGHT

Press to turn the fan's light on/off.



LED INDICATOR

Displays in the white color. Represents the brightness of fan's LED. (There are 8 levels).



LIGHT DIMMING CONTROL

Will allow user to configure fan's light intensity up/down.



LIGHT INTENSITY UP

Press to increase fan's light intensity. Long press to set fan's light on high.



LIGHT INTENSITY DOWN

Press to decrease fan's light intensity. Long press to set fan's light on low.



FAN

Press to turn the fan on/off. Press and hold for a minimum of 5 seconds to change fan's direction.



POWER DISCONNECT SWITCH

Press to disconnect fan's power from the main.



FORWARD DIRECTION INDICATOR

Displays in the blue color. Represents the fan moving in the forward direction. (There are 8 levels).



REVERSE DIRECTION INDICATOR

Displays in the green color. Represents the fan moving in the reverse direction. (There are 8 levels).



FAN SPEED UP

Press to increase fan's speed. Long press to set fan's speed on high.

BASIC WALL CONTROL ICONS



FAN SPEED DOWN

Press to decrease fan's speed. Long press to set fan's speed on low.

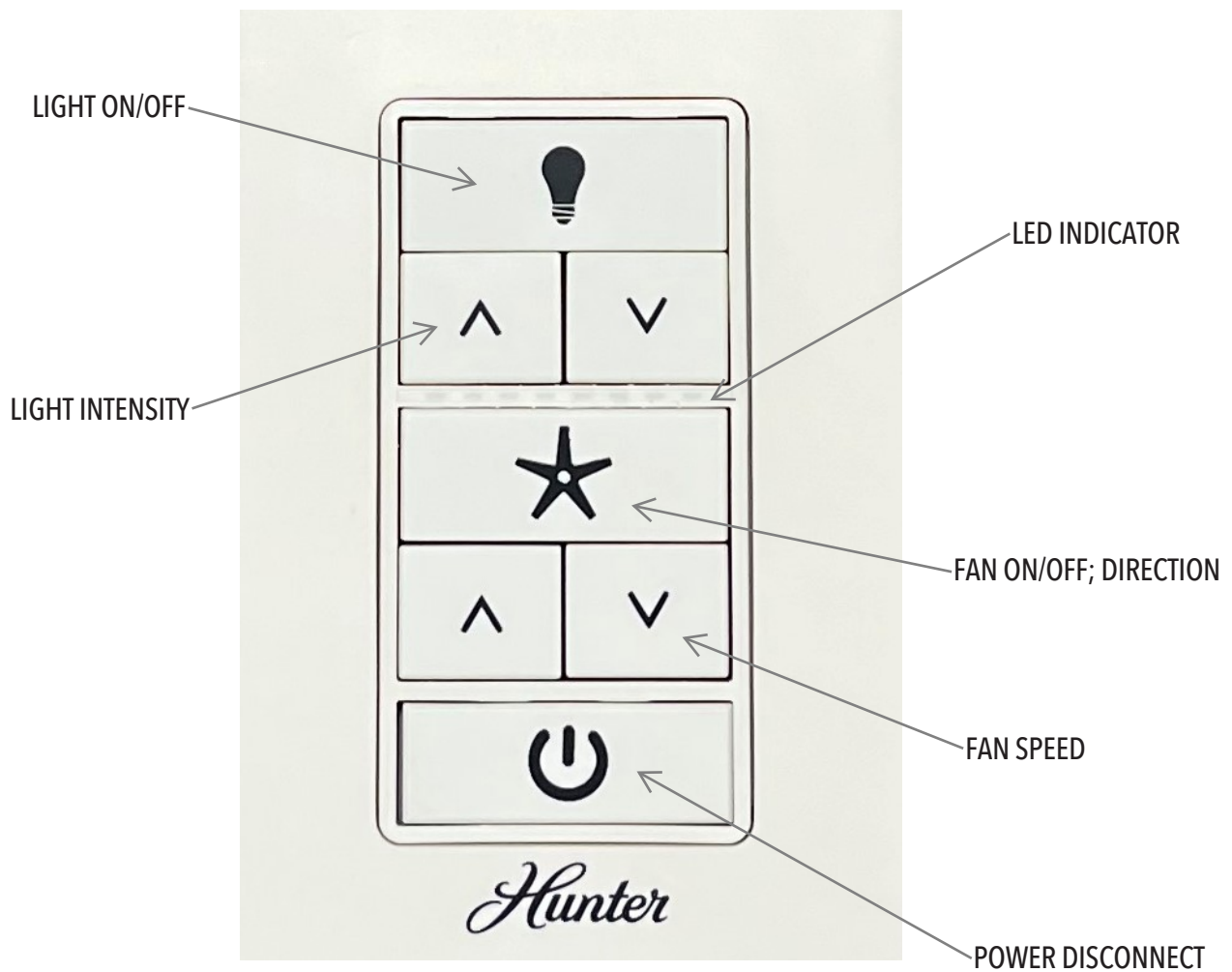

3"/4" TOUCHSCREEN WALL CONTROL ICONS



POWER BUTTON

Select to turn fan off/on.



FAN SPEED SLOWER

Select to decrease the speed of the fan.

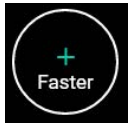

FAN SPEED FASTER

Select to increase the speed of the fan.



FAN SPEED INDICATOR

Indicates what level the fan's speed is on. (There are 10 levels).



LIGHT CONTROLS

Select to go to the lighting menu to adjust the light intensity.



FAN DIRECTION

Select to change the direction of the fan between reverse or forward.



FAN LIGHT DIMMER

Select to dim the fan's light.



FAN LIGHT BRIGHTER

Select to brighten the fan's light.



LIGHT INDICATOR

Indicates what level the fan's light is on. (There are 10 levels).



FAN CONTROLS

Select to go to the fan menu to adjust the fan speed.

3" TOUCHSCREEN WALL CONTROL ICONS

FAN SPEED/DIRECTION

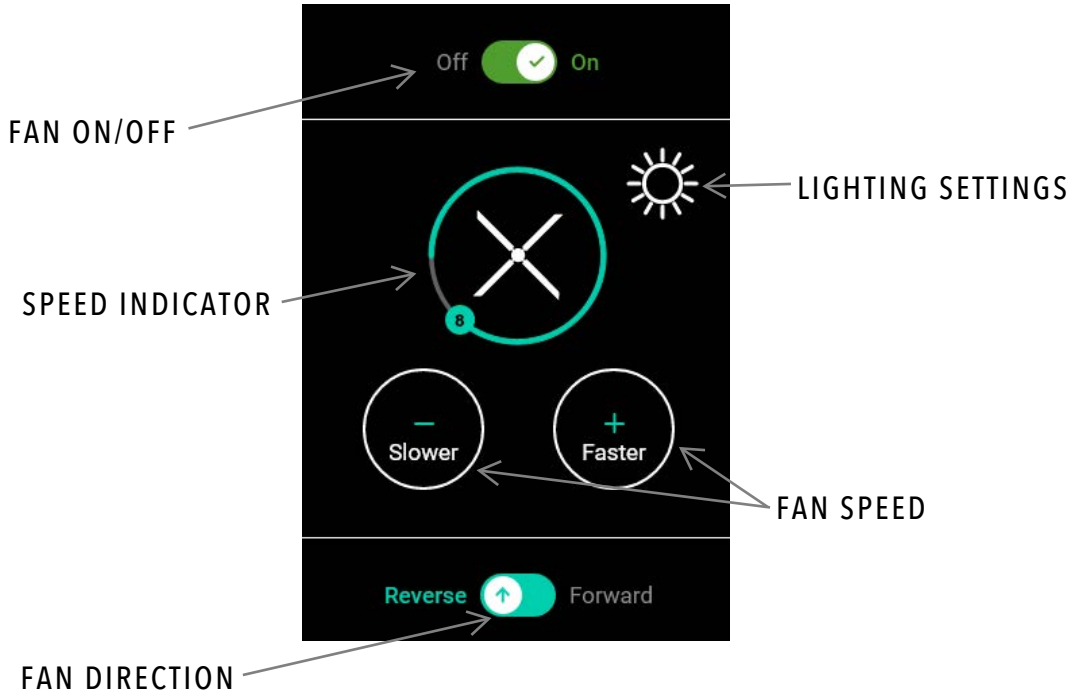

FAN LIGHTING

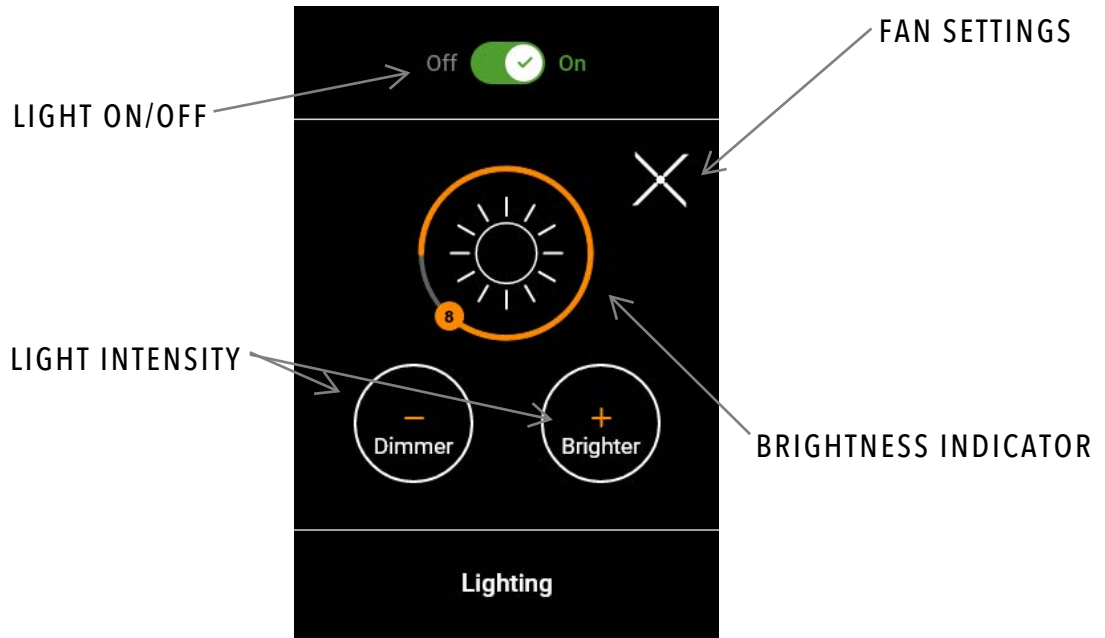

4" TOUCHSCREEN WALL CONTROLS ICONS

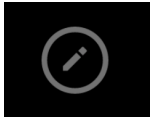

EDIT

Signifies the ability to edit a title of the fan or zone.



MENU

Provides access to various options specific to a fan or a zone.



SETTINGS

Will allow the user to configure a fan or a zone.



ZONE

Signifies if a fan or series of fans are included in a zone.

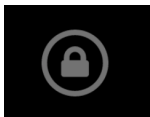

LOCK

Signifies if the fan is locked or unlocked, which will limit certain functionality of the fan.

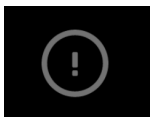

ALERTS

The Fan has experienced an abnormal condition or defect at the component, equipment, or sub-system level which may lead to a failure.



NETWORKS

Signifies data related to the fan's communication network.



FAN MODEL

Indicates the model of the Hunter Industrial Fan.



BACK ARROW

Will take the user to the previous page.



SCHEDULE

Allows the user to schedule a fan or zone's time of operation.

BASIC WALL CONTROL MOUNTING

Mountable directly to a standard single gang junction box.

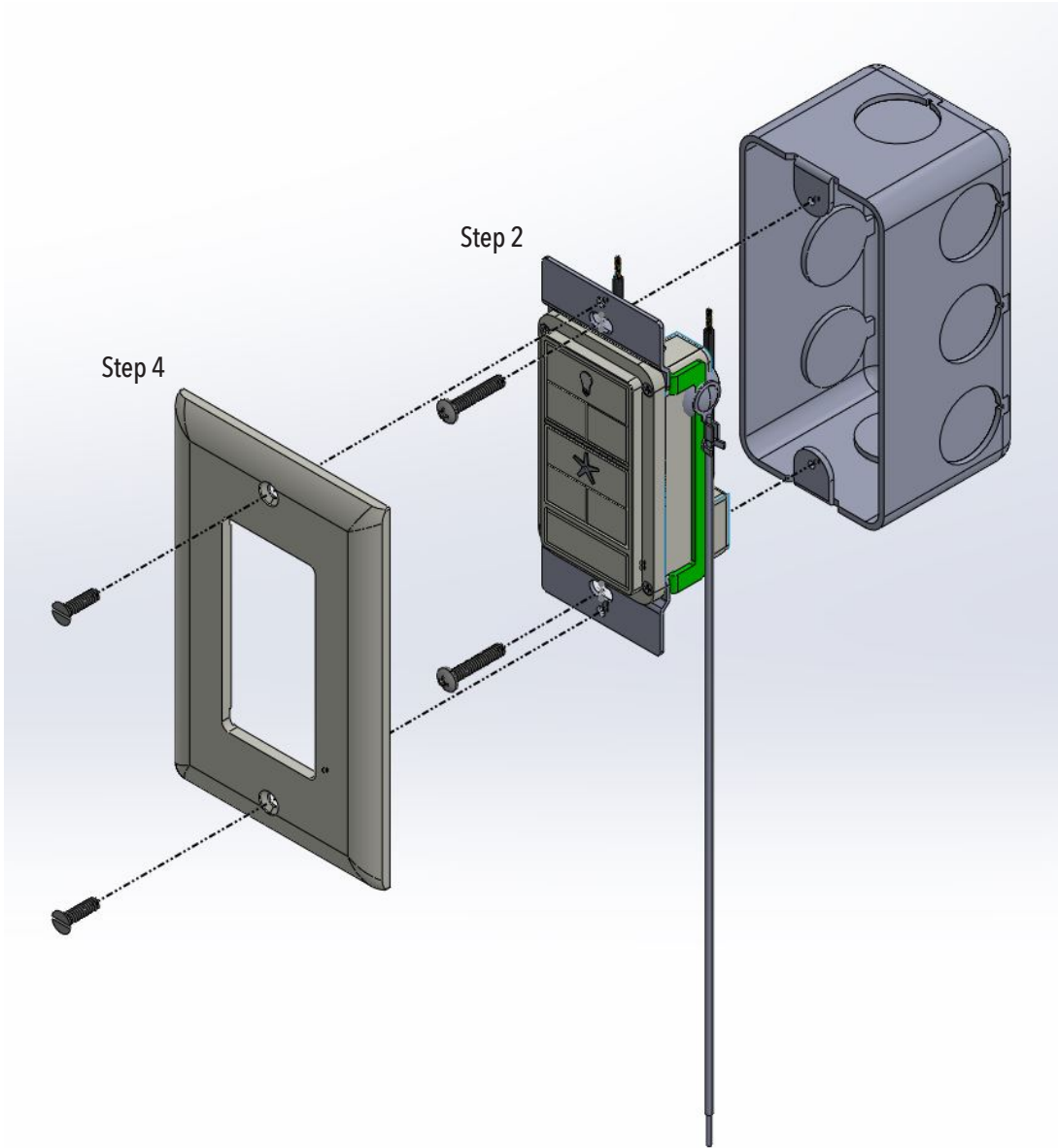

BASIC WALL CONTROL INSTALLATION

1. Turn off the power. Before installation, ensure the power is OFF at the outlet box and wall switch location before proceeding with installation.

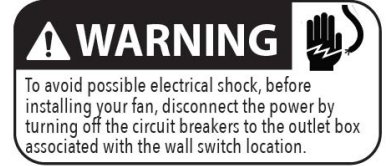

2. Installing the Basic Wall Control. Install the longer screws through the slots in the wall control into the switch box screw holes.

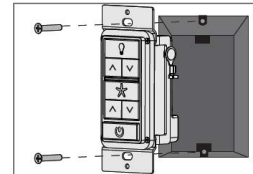

3. Wiring the Wall Control.

- a. Connect the grounding wire from the wall control to the ground control from the switch box using the provided wire nuts.
- b. Connect the "LIVE IN" from the switch box to the "~VAC" from the wall control using the provided wire nuts.
- c. Connect the "LIVE OUT" from the switch box to the "FAN" out from the wall control using the provided wire nuts.
- d. Connect the CAT5 Ethernet cable from the fan to the controller.
- e. Push all wires into the switch box.

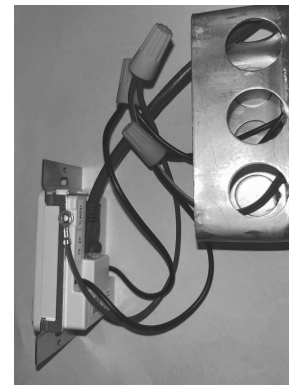

4. Installing the Wall Plate. Install the shorter screws through the wall control plate and into the screw holes in the wall control.

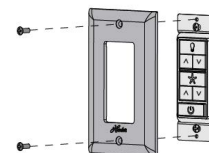

5. Turn on the power before operation.



3" TOUCHSCREEN WALL CONTROL MOUNTING

Mountable directly to a standard single gang junction box.

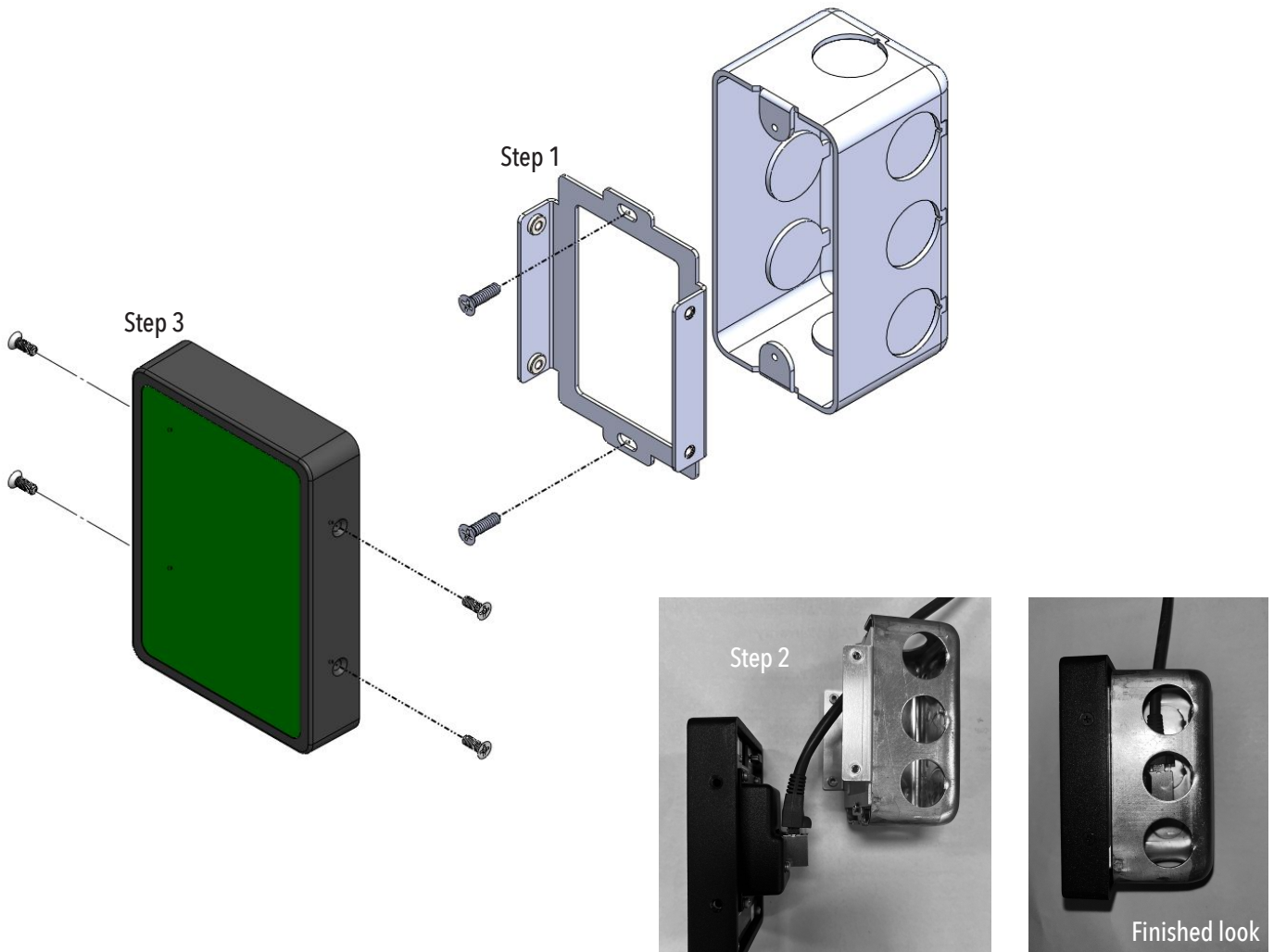

1. Mount the bracket directly to the junction box using the provided screws. (qty. 2).
2. Connect the CAT5 Ethernet cable to the controller.
3. Attach the 3" Touchscreen Wall Control to the mounting hardware using the provided screws (qty. 4).

4" TOUCHSCREEN WALL CONTROL MOUNTING

Mountable directly to a standard single gang junction box.

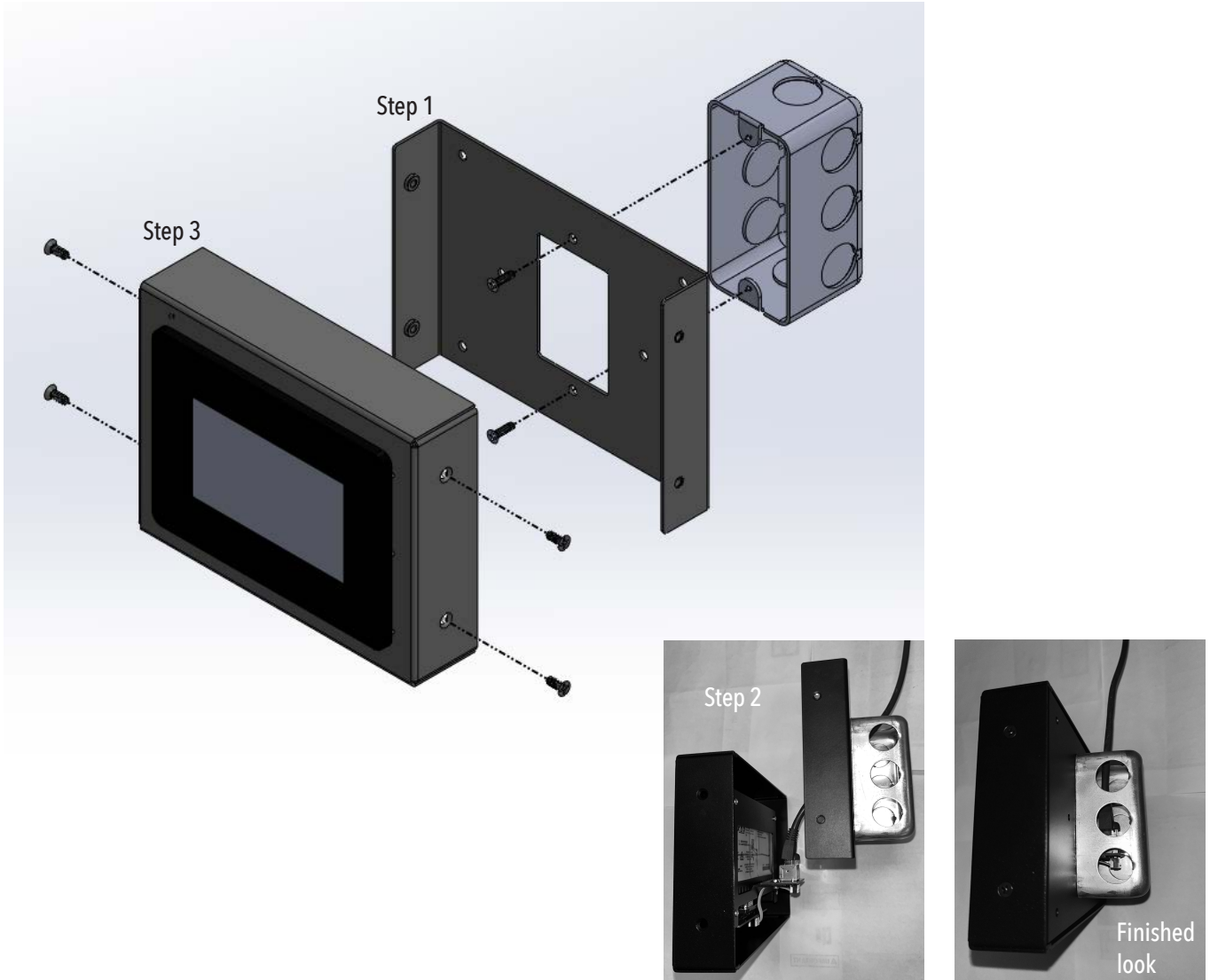

1. Mount the bracket directly to the junction box using the provided screws. (qty. 2).
2. Connect the CAT5 Ethernet cable to the controller.
3. Attach the 4" Touchscreen Wall Control to the mounting hardware using the provided screws (qty. 4).

4" TOUCHSCREEN WALL CONTROL INITIAL CONFIGURATION

1. After initial boot-up, enter the quantity of fans that are to be on the fan network and controlled by the controller interface.

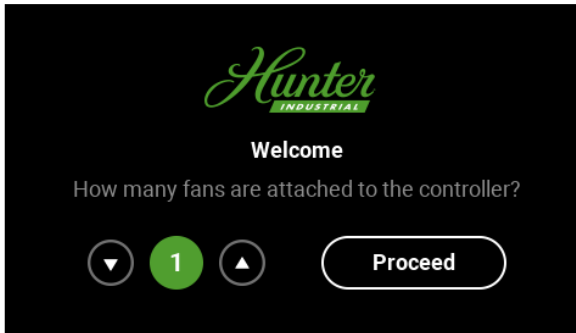

2. Create a 4-Digit Admin Pin. Future input of the Admin Pin grants access to full set-up, configuration, and operation of the fans on the network.

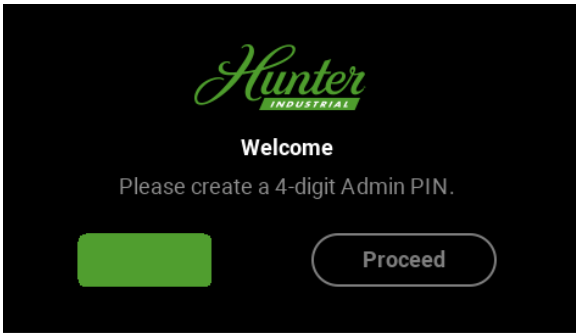

3. Choose whether to have the controller lock when not in use. A 4-digit pin configured by the user unlocks the screen. The Unlock 4-Digit Pin can be different than the 4-Digit Admin Pin.

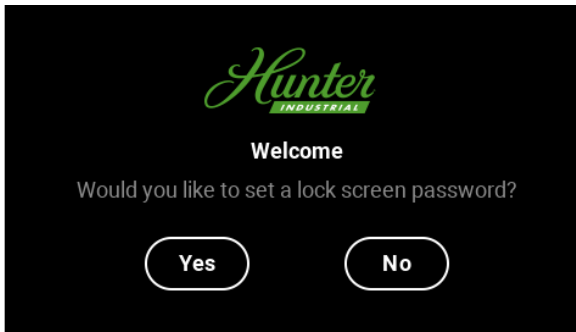

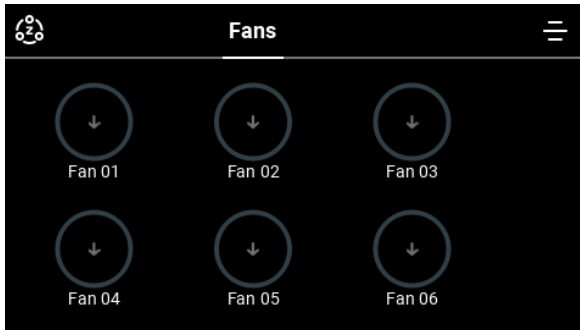

4" TOUCHSCREEN WALL CONTROL INITIAL CONFIGURATION

4. The controller will automatically find the quantity of fans that are properly installed on the network. These fans will appear on the Fan Home Page.

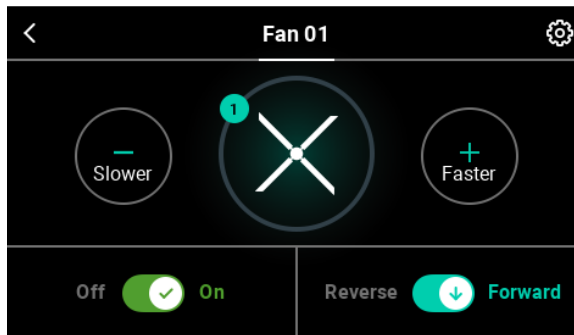
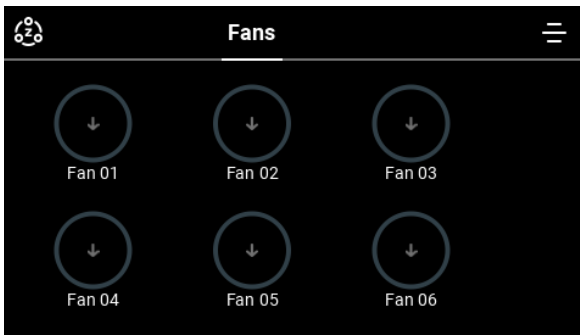

5. Users can configure and name a fan by selecting a fan from the Fan Home Page.



Select  to configure the fan selected.

Select  Name Fan 01 > to name the fan. Repeat these steps for each desired fan.

4" TOUCHSCREEN WALL CONTROL LIGHT CONFIGURATION

If your fan comes with a light module then you have to activate the light function in the controller. To do so follow the steps below:

1. Select  to access the menu.

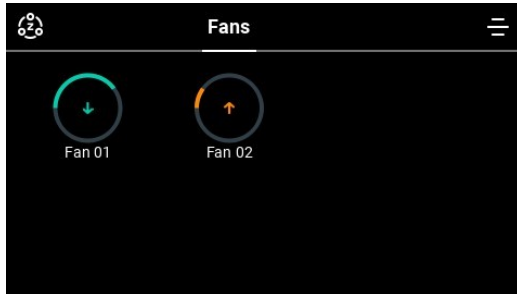

2. Select "Accessibility" followed by "Admin Login".

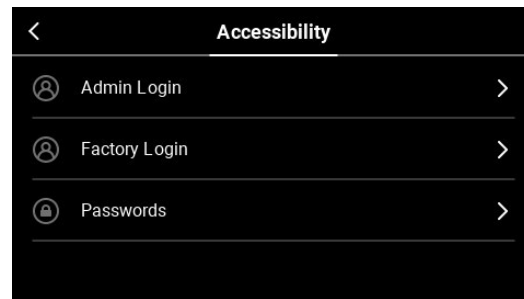
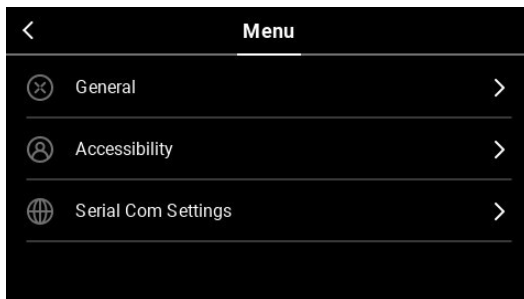

3. Enter your 4-digit pin to access the Admin mode. Once entered select  to go back to the fan menu.

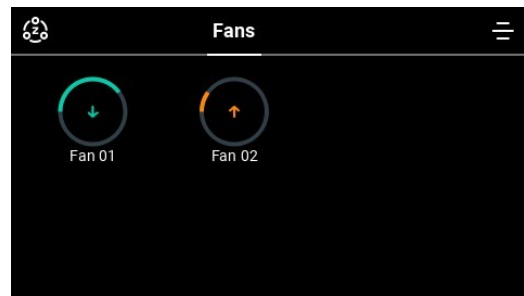
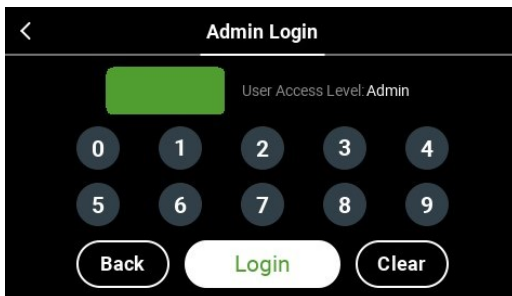

4. Select which fan to add the light function to.

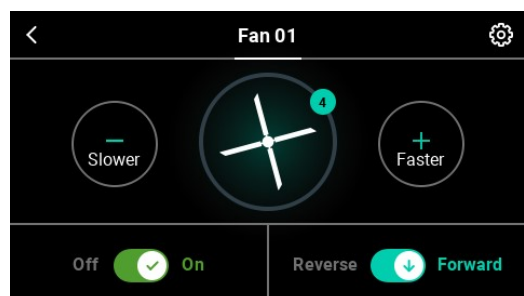
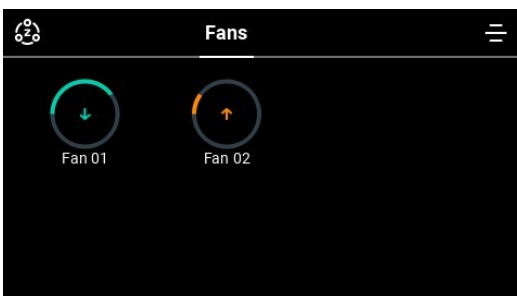

4" TOUCHSCREEN WALL CONTROL LIGHT CONFIGURATION

5. Select  to go into the settings menu of the selected fan.

6. Once in the settings menu, scroll down to "Enable LED" line.

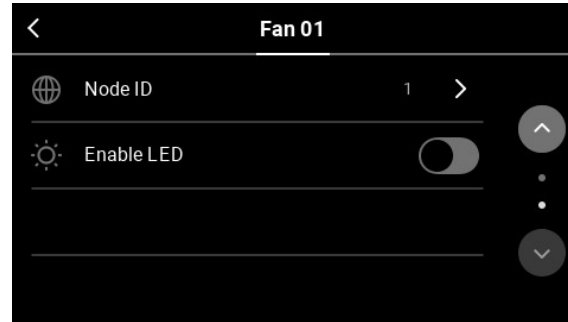
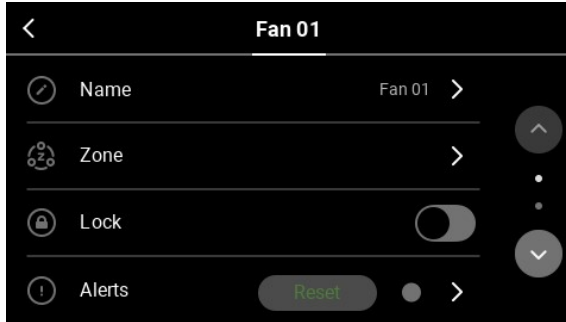

7. Select  to activate the LED function of the fan.



8. Select  to get back into the main menu.

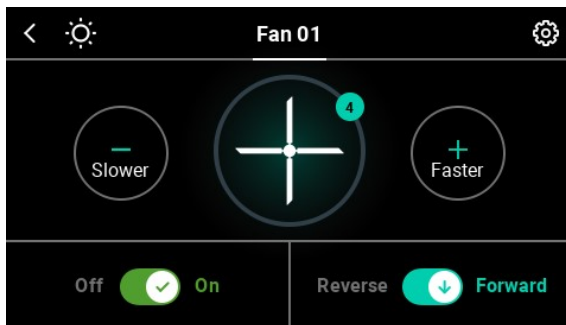

9. Select  to access controls for the light.



10. Now there is access to the fan's light controls. Select either  or  to control the intensity of the light. (There are 10 levels).

OPERATING THE FAN OR ZONE

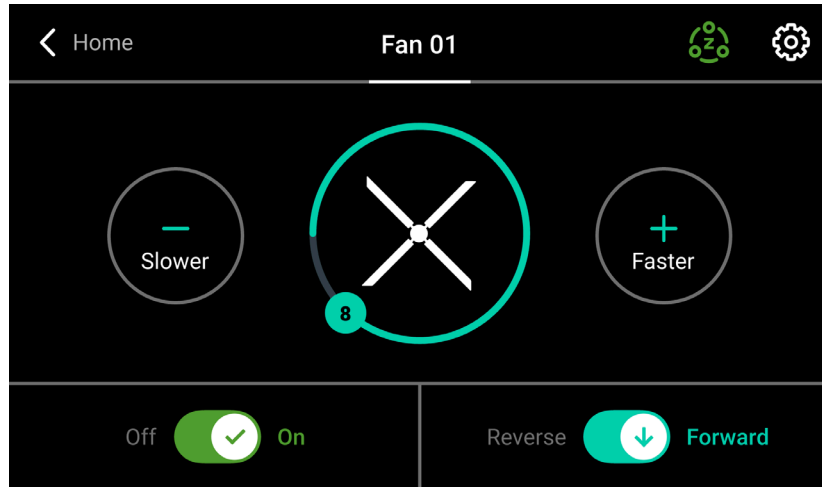

FAN CONTROL PAGE

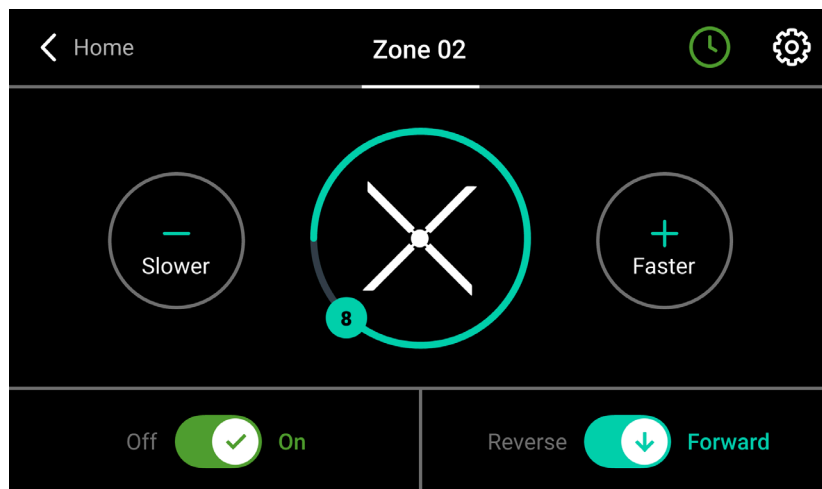

ZONE CONTROL PAGE

ACTIONS FOR OPERATING A FAN, OR ALL FANS IN A ZONE, ARE THE SAME.

ON/OFF



- The toggle will turn green when in the "on" position.
- The fan must be turned "on" before being able to adjust speed or fan direction.

OPERATING THE FAN OR ZONE

CONTROLLING FAN SPEED

- Control the fan speed (speeds 1-10) by pressing the slower or faster buttons.



- Number in the circle represents the commanded speed setting.
- Outside band of the fan icon represents the speed at which the fan is at while ramping up or slowing down to the commanded speed.

FAN DIRECTION





- If the fan has experienced an Alert or Fault signified by the item in the red box below, view the alert/fault code by selecting

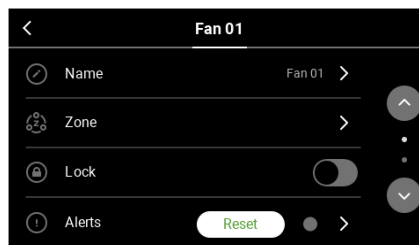
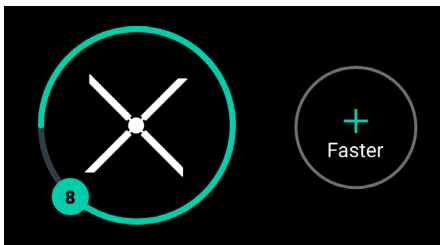

RESET THE FAN AFTER AN ALERT



- Select  from the Fan Control Page.
- Select the reset button to reset the fan. 
- A long-history of alerts (faults) is also maintained, and can be cleared if desired.

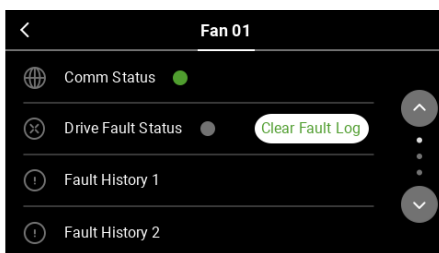

CREATING AND CONFIGURING A ZONE

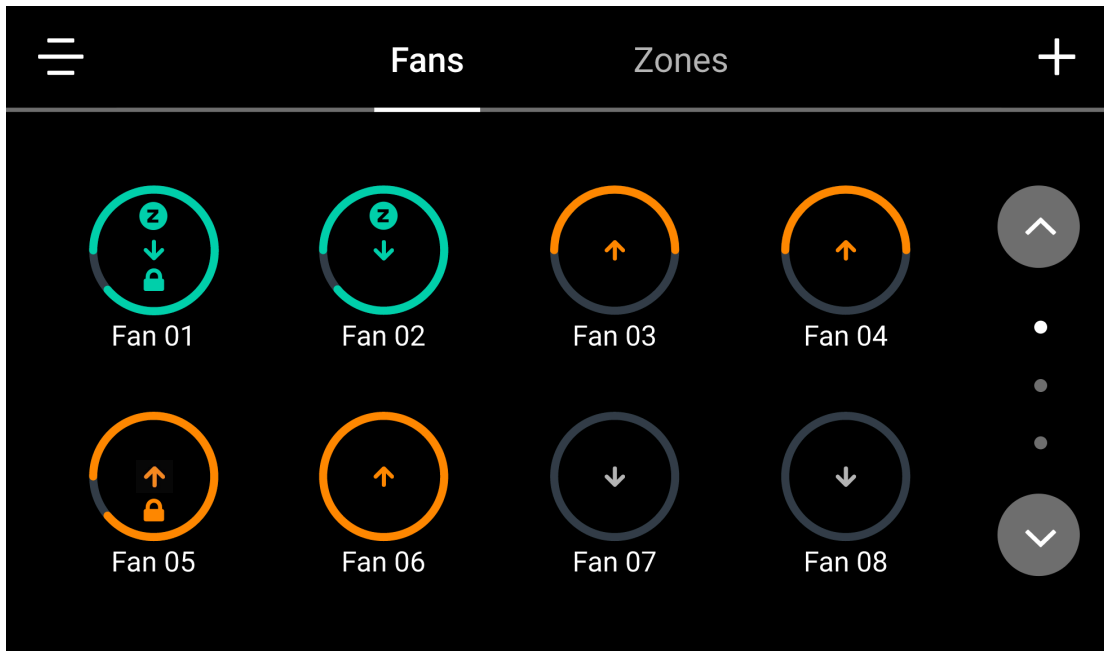

FAN HOME PAGE

FANS CAN BE ADDED TO A ZONE. FANS IN A ZONE WILL OPERATE IN THE SAME MANNER, DICTATED BY THE ZONE'S SCHEDULE, DIRECTION, AND SPEED SETTING.

- To configure a zone, or add fans to a zone select:



- Select a zone to configure.

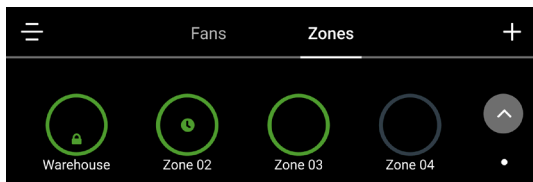

- Select  to configure the zone selected.

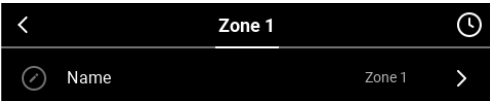
- Select  to name the zone.

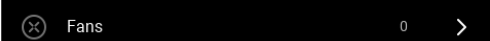
- Select  to include available fans in a zone.

CREATING AND CONFIGURING A ZONE

- Select the fans to be added to the zone, then click save.

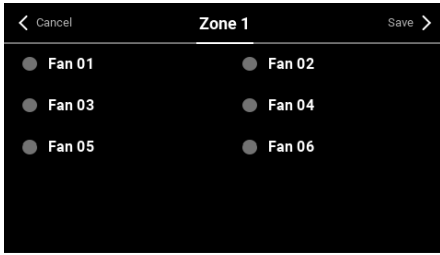

- Select  to configure the zone selected.

- Select  to enable the schedule.

- Select  to lock the fan or zone.

FANS CAN ALSO BE ADDED TO A ZONE FROM THE FAN CONTROL PAGE.

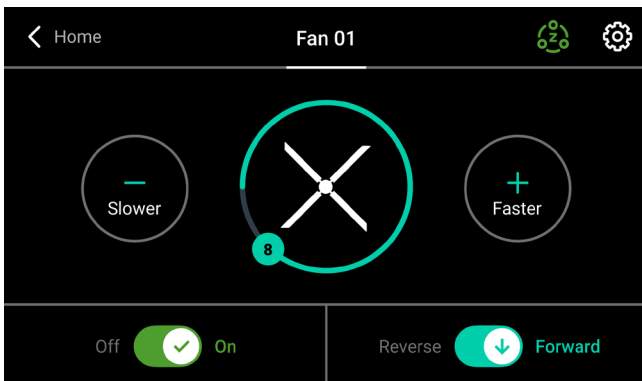

- Select  to configure the fan.

- Select  to select a zone.

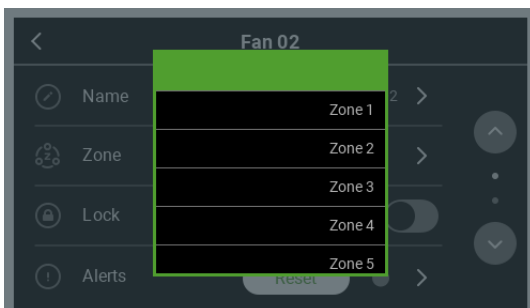

- Select which zone to include the fan to.

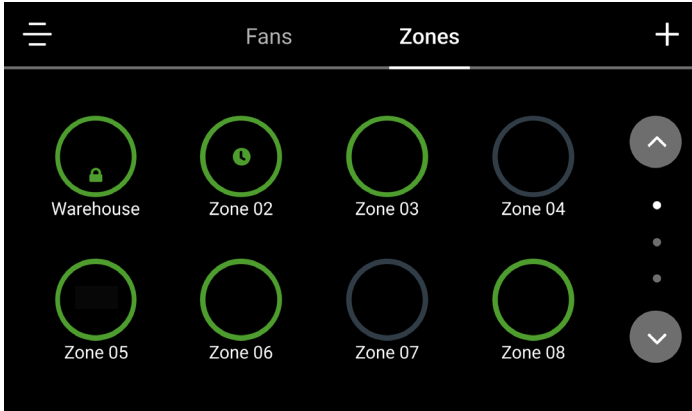

SCHEDULING A FAN OR ZONE

- Select  from the Fan Home Page to be directed to the Zone Home Page.



- Select zone to schedule.
- Select  to configure the zone selected.
- Select  to schedule the fan or zone's operation.



SCHEDULING A FAN OR ZONE

- A fan or a zone is able to have three (3) scheduled Actions of operation per day.
 - ◇ An Action = start, stop, or a change in fan(s) speed or direction.
 - Select the day of the week the fan or zone is to perform the scheduled Action.
 - Select the fan Action: on/off, forward/reverse.
 - Set the start time desired for the fan(s) Action to begin.
 - Set the desired fan(s) speed for the scheduled time.
 - The fan(s) will now follow this scheduled operation until the next Action is scheduled to begin.
-

Notes:

- *Scheduling a single fan requires including the fan into a zone, and then scheduling the zone.*
- *Fans must be unlocked to modify schedules or zones.*

TROUBLESHOOTING

Follow all safety practices and instructions during the installation, operation, and servicing of the fan. Failure to apply these safety practices could result in death or serious injury. If you do not understand the instructions, please call our Technical Service Department at 1-844-591-FANS (3267) or email us at fansupport@hunterfan.com for guidance.

PROBLEM	SOLUTION
Fan will not start, or 3"/4" Touchscreen Wall Control is blank	Verify that the fan's circuit breaker has power and that it is on.
	Check for secure plug connections across the system. Each connection should be checked to ensure fully engagement.
	Check for loose wiring connections. Each termination should be firmly tightened.
	Loosen canopy, check all wiring connections.
Fire Relay Fault	If the fire alarm went off, once that system resets, the fault should clear.
	If the fire alarm did not go off, cycle the power by flipping the circuit breaker off for a minimum of 3 minutes.
Excessive Wobbling	Make sure the blades are properly installed on the blade iron posts. If wobbling continues after checking, remove and re-install the blades again.
	Tighten all screws.
	Make sure the fan is secure on the hanger bracket.
	Turn power off, support fan very carefully and check that the hanger ball is properly seated.

ALERT CODES

Alerts may occur that cause stoppage of the fan(s). Some alert instances can be remedied by resetting the fan from the wall control. The following alerts may be remedied via reset:

ALERT CODE	DESCRIPTION OF ALERT FOR 3"/4" TOUCHSCREEN WALL CONTROL
E.OC1	Overcurrent trip during acceleration/deceleration/constant speed.
E.OV1	Regenerative overvoltage trip during acceleration/deceleration/constant speed.
E.THM	Motor overload trip.
E.FIN	Fin overheat.
E.LF	Output phase loss.

Hunter

w.w.Cannon, Inc.

Design. Layout. Build. Install.

1-800-442-3061
www.wwcannon.com