



BLUFF



PRODUCT GUIDE



TABLE OF CONTENTS

| | |
|---|----|
| YARD RAMPS | |
| Portable Yard Ramp, Stationary Yard Ramp, Options | 4 |
| PORTABLE DOCK / PLATFORM | |
| Portable Dock/Platform, Options | 5 |
| SPECIALTY RAMPS | |
| Mini Ramp, Container Ramp, Walk Ramp, Crossover Ramp | 6 |
| BRIDGE THE GAP | |
| Crossover Bridge, Rail Board | 7 |
| DOCK BOARD SELECTION GUIDE | |
| Selection Guide, Portability Options | 8 |
| STEEL DOCK BOARDS | |
| Models T, TFL, C, TNB, SC and Speedy Board | 9 |
| ALUMINUM DOCK BOARDS & PLATES | |
| Models AC and BC, Model ATD | 10 |
| SPECIALTY DOCK PLATES | |
| Spring Loaded Dock Plate, Gas Cylinder Plate | 11 |
| DOCK LEVELERS | |
| Edge of Dock Leveler and Lo-Dock Leveler | 12 |
| WHEEL RISERS & TRUCK RISERS | |
| Aluminum and Steel Wheel Risers, Steel Truck Risers | 13 |
| GUARD RAILS | |
| Tuff Guard®, Modular Protective Barrier | 14 |
| RACK PROTECTION | |
| Rack Guard, Post Protector, Guide Rail | 15 |
| DOCK DOOR SAFETY | |
| Door Guard, Goal Post, Bollard, Barrier Gate | 16 |
| WAREHOUSE SAFETY | |
| Pipe Guard, Corner Guard, Building Column Guard, Machine Guard | 17 |
| MEZZANINES & GATES | |
| Mezzanine, Slide Gate, Pivot Gate, Swing Gate | 18 |
| OTHER STEEL STRUCTURES | |
| Stairway and Landing, Ladder, Conveyor Crossover | 19 |
| CANTILEVER RACKS | 20 |
| CARTS, STORAGE & HANDLING | |
| Packing Box Rack, Order Picker Cart, Custom Carts | 21 |
| OTHER STORAGE & HANDLING | |
| Keg and Wine Flow Rack Inserts, Slab Handling, Sheet Rock Dolly | 22 |
| CUSTOM PRODUCTS | 23 |
| WAREHOUSE MAP | 24 |

YARD RAMPS



PORTABLE YARD RAMP Model SYS

- Ground-to-truck application
- All-welded steel construction with steel grating
- Standard capacities from 16,000 to 30,000 pounds
- 36' design includes 6' level-off
- Widths from 70" to 96"
- Higher capacities and custom designs available
- Beveled approach provides a smooth transition
- Includes full undercarriage with solid 18" rubber tires
- Safety chains included to secure Yard Ramp to trailer
- Option of tow bar or ramp clamp when ordering
- Double-action hydraulic pump allows for smooth and quick raise of the front lip to the proper trailer height
- Options include: handrails, edge of dock or pit leveler, platform connection, ladder or stairs, hinged lip, fixed or adjustable legs, pneumatic wheels, caster jack legs
- Manufactured in 7 working days and shipped from TX
- Standard models stocked in GA and MD for quick shipment



STATIONARY YARD RAMP Model SYSNU

- Ground-to-dock ramp
- All-welded steel construction with steel grating
- Standard capacities from 16,000 to 30,000 pounds
- Fixed model is standard
- 30' all-incline design
- Widths from 70" to 130"
- Higher capacities and custom designs available
- Beveled approach provides a smooth transition
- Safety chains and chain brackets included to secure Yard Ramp to a dock or Steel Platform
- Options include: handrails, recessed curbs, dock extension, platform connection, undercarriage for portability
- Manufactured in 7 working days and shipped from TX



PORTABLE DOCK / PLATFORM

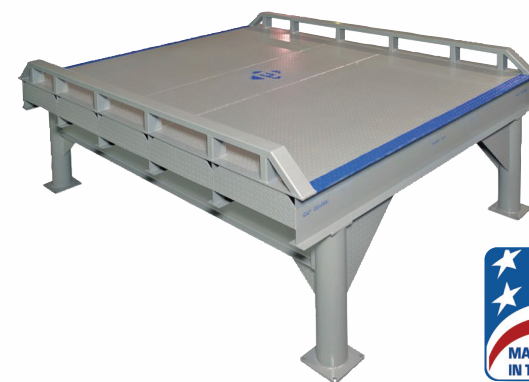

PORTABLE DOCK / PLATFORM Model SP

Bluff Steel Platforms are an efficient way to create a loading dock when there's not one available on site for shipment deliveries at a warehouse or railway facility. These can be used as a free-standing setup, or can be used in conjunction with a yard ramp to increase loading capabilities. Steel Platforms come in either a fixed height or with adjustable legs depending your application requirements.



- All-welded steel construction
- Diamond tread travel surface
- Standard capacities from 16,000 to 30,000 pounds
- Higher capacities and custom designs available
- Options include: handrails, edge of dock or pit levelers, hinged lip, fixed or adjustable legs, yard ramp connection, ladder or stairs
- Manufactured in 10 working days and shipped from TX

OPTIONS



OPTIONS

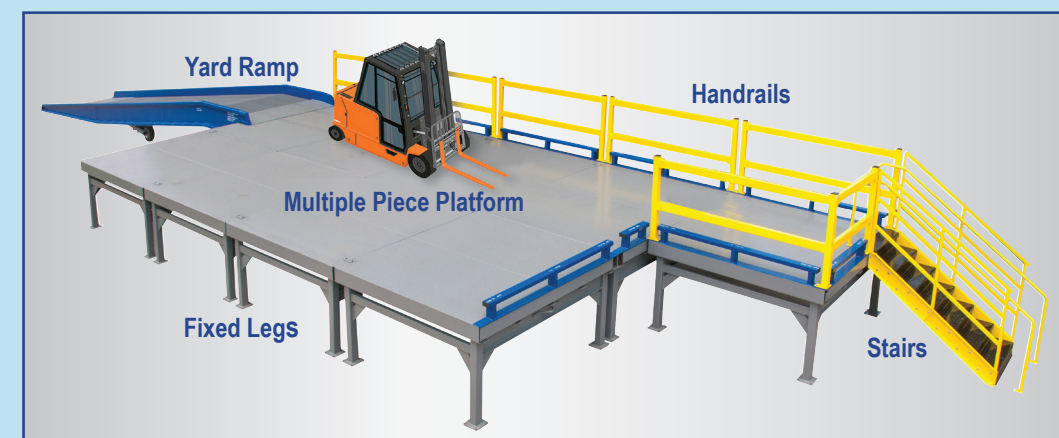

SPECIALTY RAMPS



MINI RAMP Model MR

- Great for ground-to-dock loading with low dock height
- All-welded steel construction with steel grating
- Standard capacities from 16,000 to 30,000 pounds
- 6" tall curbs on each side serve as runoff protection
- Standard widths of 70" or 84"
- 15' long ramp services dock heights from 17" to 30"
- 18' long ramp services dock heights from 20" to 32"
- Higher capacities and custom designs available
- Safety chains included to secure Mini Ramp to dock
- Add MRSJ screw jack kit for portability. Kit includes two screw jacks with rigid steel casters mounted at the ramp's balance point
- Handrails optional
- Manufactured in 7 working days and shipped from TX



CROSSOVER RAMP Model COR

- Safely traverse over pipes, hoses or cables
- All-welded steel construction
- Standard capacities from 5,000 to 30,000 pounds
- Curbs optional for runoff protection
- Higher capacities and custom designs available
- Can be modified for fracking site applications
- Worksheet required

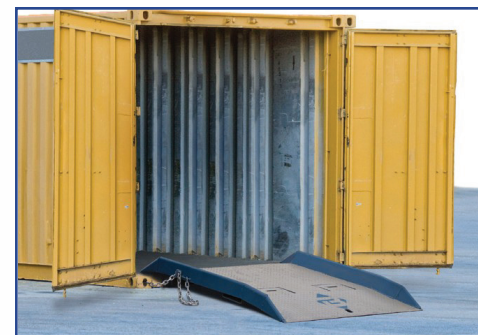

CONTAINER RAMP Model CR

- Allows smooth transition from ground to bed of shipping container
- All-welded steel construction
- Standard capacities from 15,000 to 30,000 pounds
- Full width stiffener bumps up against the container for stability
- Locking chains included to lock ramp into place
- 4" tall curbs on each side serve as runoff protection
- Widths starting at 60"
- Higher capacities and custom designs available
- Manufactured in 5-7 working days and shipped from TX
- Standard models stocked in CA for quick shipment



WALK RAMP Model WR

- Lightweight aluminum construction
- Hook or Apron options
- Lengths from 3' to 16'
- Widths of 29" or 39"
- Capacities from 500 – 3,000 lbs
- Not intended for use with powered equipment or pallet jacks
- Ships in 5-7 working days from factory in MI

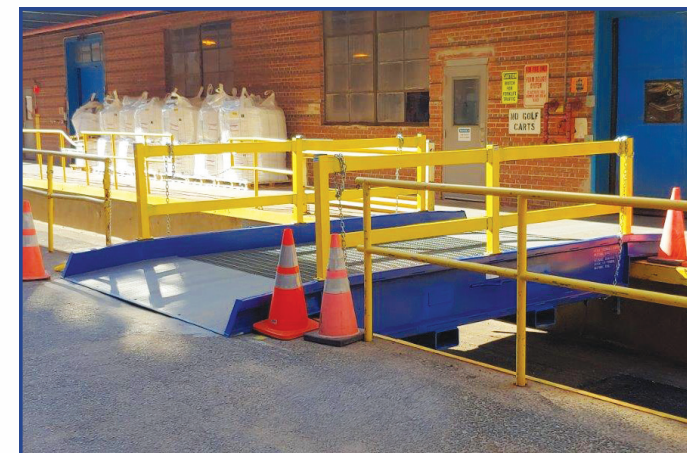

CROSSOVER BRIDGE Model COB

- Bridge the gap between ditches, waterways, uneven topography or multiple levels in a warehouse
- All-welded steel construction with steel grating
- Standard capacities from 16,000 to 30,000 pounds
- Portability options on some models
- 8" tall curbs for runoff protection



RAIL BOARD Model R

- For use with transitioning between a dock and rail car for safe loading
- All-welded steel construction
- Standard capacities from 15,000 to 90,000 pounds
- Heavy duty locking rings for secure positioning
- Recessed lifting loops are standard
- Worksheet required
- Options: 10, 20 or 30 degree flared dock side width, and lifting chains instead of loops
- Manufactured in 10-12 working days and shipped from TX



Locking Ring Design

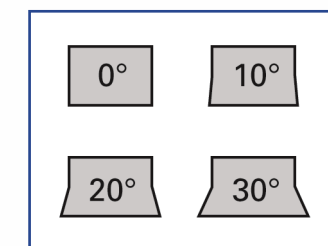

Flare Options



Understructure



BRIDGE THE GAP

- Option for handrails – for gap depths of more than 48", handrails are recommended
- Higher capacities and custom designs available
- Drawbridge design capability
- Worksheet required for proper design
- Manufactured in 7-10 working days and shipped from TX

DOCK BOARD SELECTION GUIDE

SELECTION GUIDE

When making dock board and/or dock plate selections, consider the extremes rather than the averages.

CAPACITY

Plates

- Weight of equipment and heaviest load

Boards

- Capacity rated for single-shift operation at a 3 mile per hour maximum rate of travel
- Stackers and other narrow aisle loaders should not be used on a dock board
- Paper roll clamp and multi-shift loading add 5,000 pounds to the board capacity

Length

To determine the proper length of a dock board/ plate, three items are required:

- Dock height (D)
- Height of highest truck and lowest truck (T)
- Gradeability of loading equipment used.

Width

Bluff recommends a minimum product width of 12" to 18" wider than the overall width of the vehicle or pallet used.

| CAPACITY SELECTION GUIDE | | |
|-----------------------------------|-----------------------------------|-------------------------|
| 4-WHEEL FORKLIFT LIFTING CAPACITY | 3-WHEEL FORKLIFT LIFTING CAPACITY | BOARD CAPACITY REQUIRED |
| 2,000 - 3,000 lbs | 2,000 lbs | 10,000 lbs |
| 3,000 - 4,000 lbs | 2,500 lbs | 13,000 lbs |
| 5,000 lbs | 3,000 3,500 lbs | 15,000 lbs |
| 5,000 - 6,000 lbs | 4,000 - 5,000 lbs | 20,000 lbs |

MAXIMUM TRAILER HEIGHT SERVED

| Truck Type | Serve Height |
|-----------------------|--------------|
| Freight Line Trailers | 46" - 56" |
| Flatbed Trailers | 50" - 60"+ |
| Bob Tail Trucks | 46" - 48" |
| Containers | 56" - 62" |
| Bob Tail Trucks | 50" - 60" |

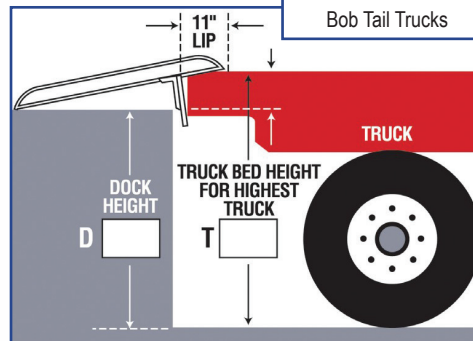

STEEL DOCK BOARDS

Rated for forklift use, **Bluff Steel Dock Boards** provide an easy transition from dock to truck while aiding in safely loading and unloading freight shipments. All steel dock boards are manufactured and tested in compliance with ANSI Standard MH30.2 and are OSHA 1910.26 compliant. Manufactured in 5-7 working days and shipped from TX. Standard models stocked in CA, WA, PA, MD, GA and NC for quick shipment.



MODEL T
Pin Style

- Capacities from 15,000 to 40,000 lbs
- Two four-hole pin pockets placed on each edge
- Above and below dock loading
- Fold-down lifting loops
- Widths from 60" - 84"
- Lengths from 48" - 120"

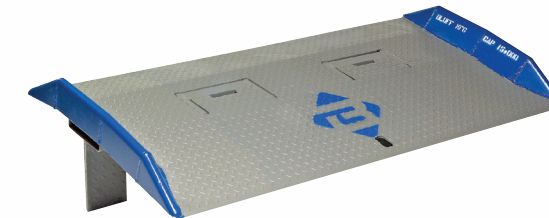

MODEL TFL
Fixed Legs

- Capacities from 15,000 to 40,000 lbs
- Fixed (locking) leg design
- Above dock loading only
- Fold-down lifting loops
- Widths from 60" - 84"
- Lengths from 48" - 120"



SPEEDY BOARD™
Scoop Style

- Capacities from 10,000 to 40,000 lbs
- Fork cutouts on leading edge - no need to leave forklift
- Fixed (locking) leg design
- Above dock loading only
- Widths from 60" - 84"
- Lengths from 48" - 120"

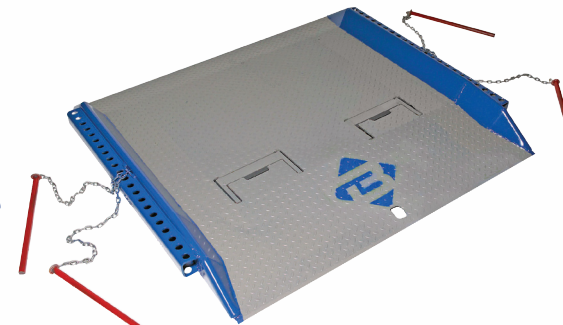

MODEL C
Full Length
Pin Pockets

- Capacities from 15,000 to 40,000 lbs
- Full length pin pockets on each side for a dual-pin locking system
- For difficult trailer-to-dock positions
- Above and below dock loading
- Widths from 60" - 84"
- Lengths from 48" - 120"



MODEL TNB
No Dockside Bend

- Capacities from 15,000 to 40,000 lbs
- Single-bend design
- Fixed (locking) leg design
- Lifting chains
- Above dock loading only
- Widths from 60" - 84"
- Lengths from 48" - 120"



MODEL SC
Light Duty

- Capacities from 10,000 to 13,000 lbs
- Light duty steel option
- Fixed (locking) leg design
- Lifting chains
- Above dock loading only
- Widths from 60" - 84"
- Lengths from 36" - 96"

PORTABILITY OPTIONS



EZ-Roll Attachment

One person positioning without the use of a forklift. Telescoping handle stores away while board is in use. Only available for aluminum models.



Lifting Chains

For use with aluminum or steel boards.



Lifting Loops

For use with steel board models T and TFL.

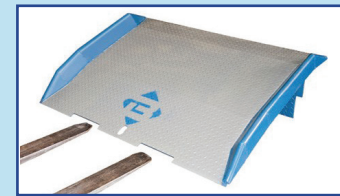

Speedy Board® Cutouts

Allows the forklift driver the ability to move, place, and retrieve the board without exiting the forklift. For aluminum and steel dock boards only. Suited for forklifts with tapered, tilt-able tines.



ALUMINUM DOCK BOARDS & PLATES



MODELS AC and BC

- Ideal for low to medium volume dock loading applications
- Designed for use with forklifts or pallet jacks
- Aluminum with bolted steel curbs

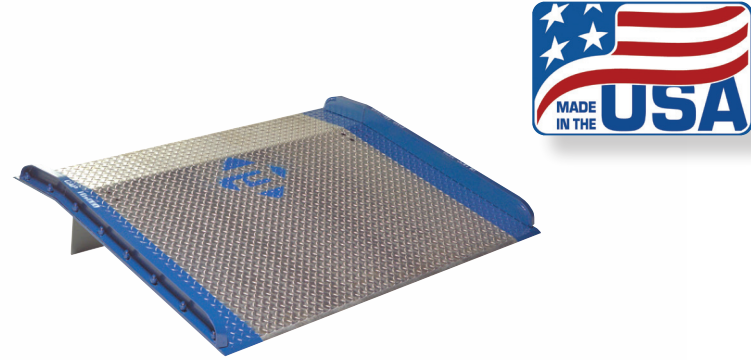

- Available in 10,000 lb or 15,000 lb capacity
- Widths from 54"-84" and lengths from 36"-96"
- Options include: EZ Roll Handles, Lifting Chains, Speedy Board Cutouts
- Manufactured in 1 working day and shipped from TX
- Standard models stocked in CA, WA, PA, MD, GA and NC for quick shipment

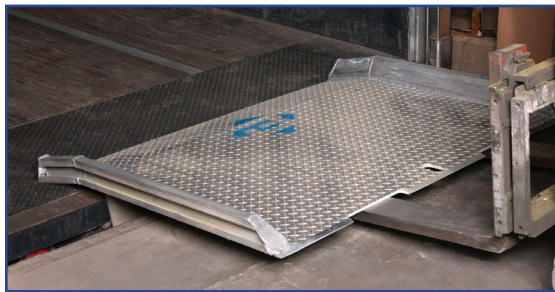

MODEL ATD

- Good in environments where sparking or corrosion are concerns
- All welded aluminum construction

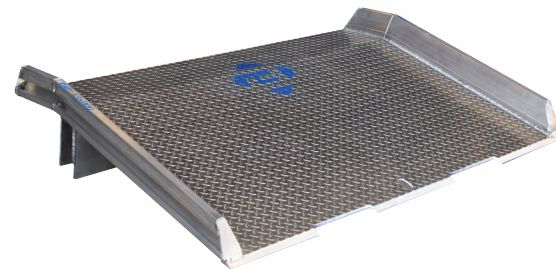

- Available in 10,000 lb or 15,000 lb capacity
- Speedy Board cutouts for lifting
- Widths from 54"-96" and lengths from 36"-96"
- Options include: lifting chains or EZ Roll Handles
- Manufactured in 5 working days and shipped from TX



DOCK PLATES

- For use in low to medium loading applications
- Not rated for forklift use – only for use with hand trucks, dollies or pallet jacks
- Aluminum with bolt-on steel legs

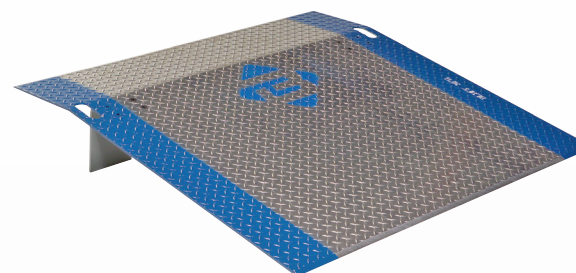

- Hand holes are standard for portability
- Widths from 36" to 72" and lengths from 24" to 84"
- Options include: EZ Roll Handles or loop handles
- Manufactured in 1 working day and shipped from TX
- Standard models stocked in CA, WA, PA, MD, GA and NC for quick shipment

SPECIALTY DOCK PLATES

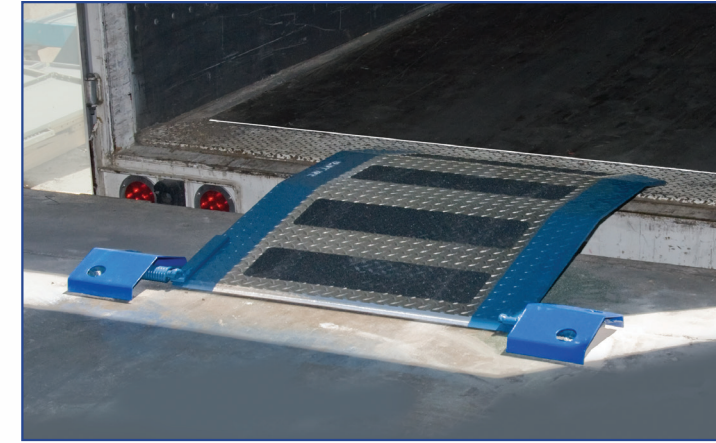

SPRING LOADED DOCK PLATE Model SL

Bluff's Spring Loaded Dock Plate (SL Plate) is an ideal solution for loading applications involving hand trucks and dollies, and is typically used by customers in the bakery, beverage and snack distribution industries. Not for use with powered equipment. Each SL Plate is site-specific and requires a completed worksheet to design.

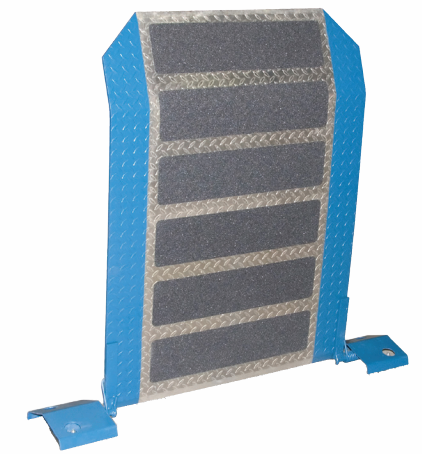

- Aluminum construction
- Actuated by hand or foot
- Stores vertically
- Widths from 30" to 72"
- Lengths from 36" to 72"
- Options include: kick plate covers, traction tape
- Worksheet required
- Manufactured in 5 working days and shipped from TX



ALUMINUM GAS CYLINDER PLATE Models AWL and AWC

Bluff's AWL and AWC Aluminum Plates are specially designed for the safe transport and distribution of industrial, medical and specialty gases. They are used as ramps for gas cylinders, while preventing damage to the cylinder and minimizing the risk of personnel injury. These are made of 3/8" aluminum diamond plate, and are light enough to be easily maneuvered by hand.

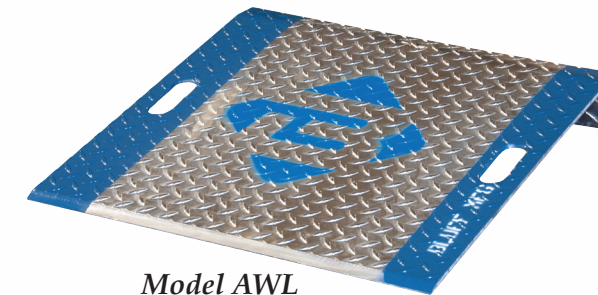

Model AWL

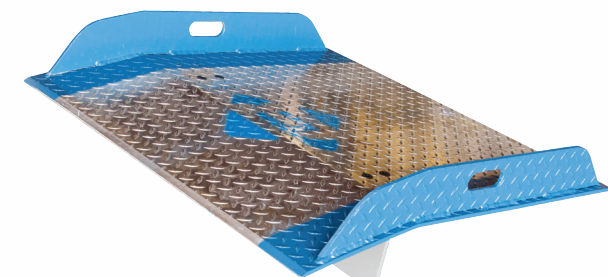

Model AWC

- All aluminum construction
- Hand holes for easy lifting
- AWL model has welded full-length leg
- AWC model has runoff curbs
- Widths from 30"-48"
- Lengths from 24"-60"
- Etched data tag optional
- Manufactured in 2 working days and shipped from TX



DOCK LEVELERS



EDGE OF DOCK LEVELER Model EP

- Correct the height difference between a dock and trailer
- Working range of 5" above and 5" below dock
- Capacities from 20,000 to 30,000 lbs
- Available widths of 66", 72" and 78"
- Self-Storing handle
- Bumper and bumper blocks included
- Conforms to ANSI MH30.1 Standards
- Optional add-ons include: anchor kit, approach plate, longer lip for refrigerated trucks, steel faced bumpers and hydraulic package
- Manufactured in 7 working days and shipped from TX
- Standard models stocked in CA, WA, PA, MD, GA and NC for quick shipment

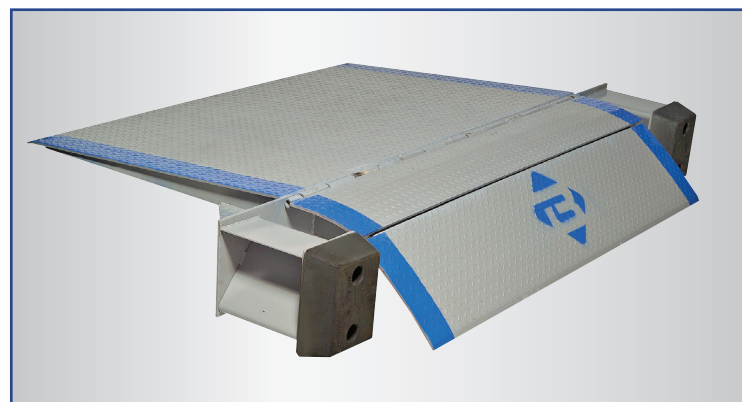

LO-DOCK LEVELER Models LD and DS

- Used to raise up a dock height anywhere from 3" to 20"
- Capacities from 20,000 to 30,000 lbs
- Available widths of 66", 72" and 78"
- Self-Storing handle
- Easily installed onto any concrete dock – no welding required
- Bumper and bumper blocks included
- Optional add-ons include: door seals, runoff curbs, anchor kit, longer lip for refrigerated trucks, steel faced bumpers and hydraulic package
- Worksheet required for Lo-Dock Levelers needing door seals
- Conforms to ANSI MH30.1 Standards
- Manufactured in 7 working days and shipped from TX

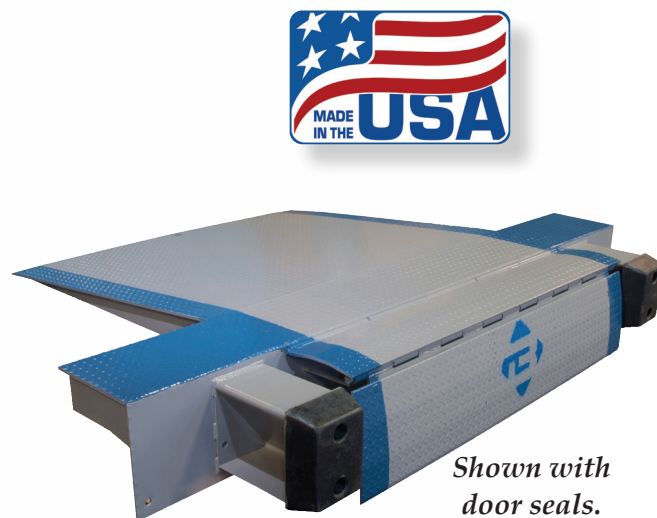
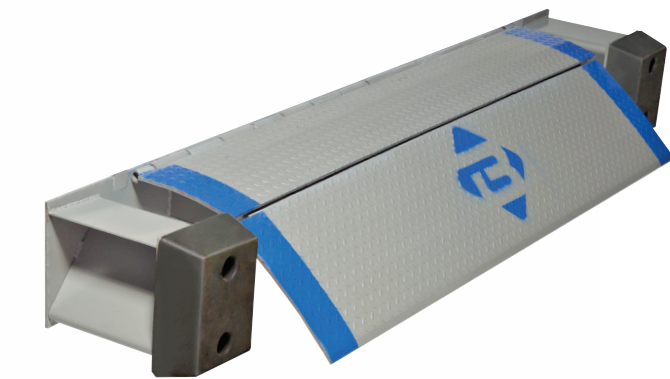

WHEEL RISERS & TRUCK RISERS



WHEEL RISERS Models SWR and AWR

- Eliminate unsafe below-dock loading conditions
- Raises up back wheels of truck
- Steel Risers are 40,000 lbs capacity per pair
- Aluminum Risers are 30,000 lbs capacity per pair
- Anchor tabs standard for steel models
- Hand holes standard for aluminum models
- Heights from 3" to 12"

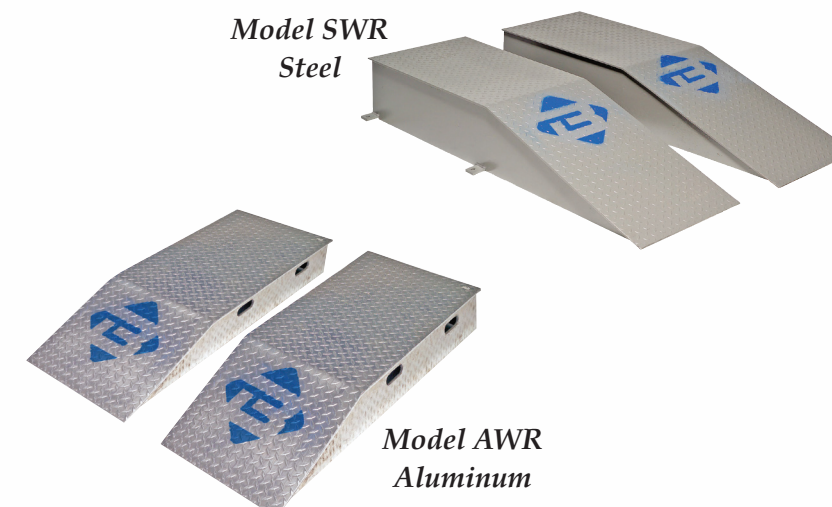

- Sizes to accommodate single or tandem axles, as well as single or dual tires
- Options include: fork pockets/notches, lifting bar, runoff curbs
- Worksheet required
- Manufactured in 6 working days and shipped from TX



TRUCK RISERS Model TR

- Raise up entire truck to meet dock height
- Steel construction with steel grating
- 40,000 lbs capacity per axle
- Heights from 6" to 24"
- Available as one piece ramp or a set of risers

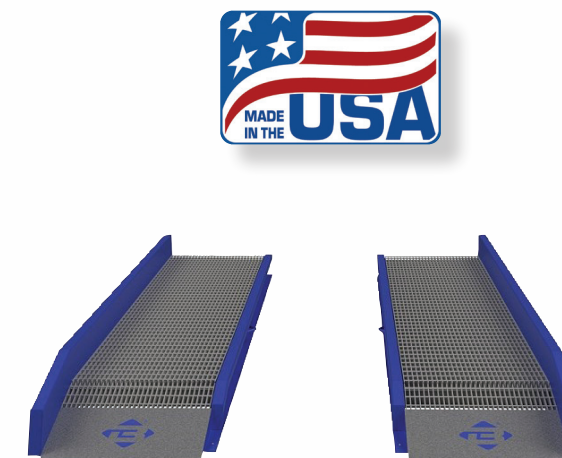

- 8" runoff curbs are standard
- Holes for anchoring
- Lengths to accommodate any type of truck
- Worksheet required
- Manufactured in 7-10 working days and shipped from TX

GUARD RAILS



TUFF GUARD® SAFETY RAILING Model TG

- Rated to withstand forklift impact of up to 10,000 lbs at 6 mph
- 4" x 4" x 3/16" structural steel square tubing posts in heights of 18", 30" or 42"
- Formed 10 gauge steel rails in lengths from 1' to 12'
- All installation hardware included



- Optional: lift-out attachments for rails, 45 Degree Angle attachment for posts
- Safety Yellow powder coat finish is standard, with other colors available upon request: orange, blue, black and grey
- Manufactured in 5-15 working days and shipped from TX



MODULAR PROTECTIVE BARRIERS Model MPB

- For pedestrian use: create in-plant walkways or safety barriers
- Lift-out rail design allows easy access to areas as needed
- 20" or 42" high posts (single or double high railing)
- 2" x 4" x 11 gauge steel tubing rails

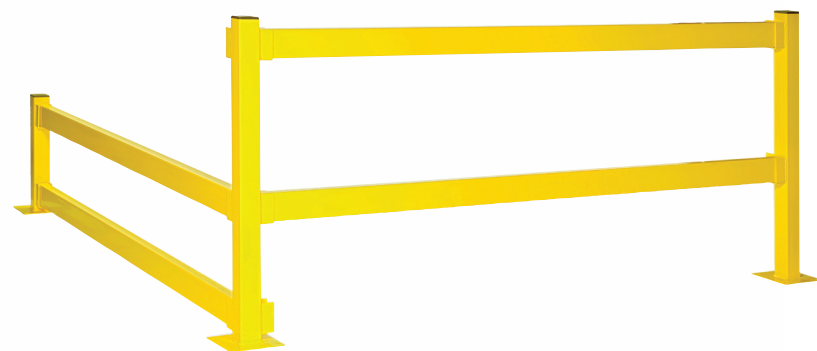

- 3" x 3" x 11 gauge steel tubing columns
- Installation hardware not included
- Floor rail option available
- Safety Yellow powder coat finish is standard, with other colors available upon request: orange, blue, black and grey
- Manufactured in 5-15 working days and shipped from TX

RACK PROTECTION

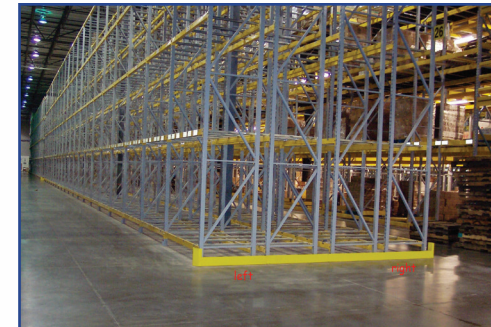

RACK GUARD Model RG

- End of Rack protection
- Heavy duty 3/8" thick steel
- 4"x6" angle size
- Wrap-around design protects both the rack ends and columns
- Bolted to floor for extra stability
- Anchor kit sold separately
- Options: left end, right end or double end columns, and extension pieces
- Safety Yellow powder coat finish is standard, with other colors available upon request: orange, blue, black and grey
- Manufactured in 5-15 working days and shipped from TX
- Standard models stocked in PA and NC for quick shipment



GUIDE RAIL Model GR

- Standard rails are 3/8" thick steel in a 3"x4" angle size
- Great for narrow aisle applications
- Comes in up to 20' length
- Custom angle sizes, lengths and designs available
- Hole size and spacing specified by customer per project requirements
- Anchors not provided
- Optional: mitered end
- Lengths up to 12' are powder coated. Safety yellow is standard with other colors available



POST PROTECTORS Model PO

- Rack post protection
- Standard height options: 12", 18" and 24"
- Available steel thickness options: 1/4", 3/8" and 1/2"
- Standard opening fits around rack post up to 4" wide
- Baseplates have four 9/16" mounting holes – anchors not included



- Safety Yellow powder coat finish is standard, with other colors available upon request: orange, blue, black and grey
- Optional: oversized opening for wider rack posts
- Manufactured in 5-15 working days and shipped from TX
- Standard models stocked in PA, MD, GA and NC for quick shipment

DOCK DOOR SAFETY



DOOR GUARDS Model DG

- Protect overhead door tracks from damage
- Chamfered edge reduces risk of hand injury when lowering door
- Wrap-around track design allows for free door operation
- Standard model projects 6" from wall
- Anchors to both wall and floor
- Columns are 3/16" thick steel
- Baseplate is 1/2" thick steel with 5/8" holes
- Hardware not included
- Safety Yellow powder coat finish is standard, with other colors available upon request: orange, blue, black and grey
- Options: no baseplate, bigger projection, 3"x3" angle design (DG48-3)
- Manufactured in 5-15 working days and shipped from TX
- Standard models stocked in CA, PA and NC for quick shipment

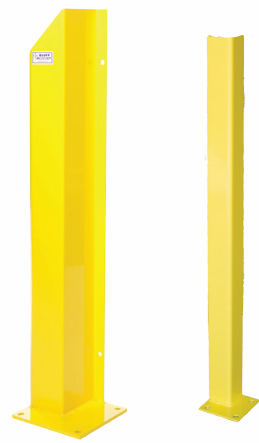

BOLLARD Model SRB

- Easy installation – no concrete work required
- 6" I.D. schedule 40 pipe
- 42" height
- Black plastic removable cap
- 1/2" x 8" x 8" baseplate with 3/4" mount holes
- Anchors included
- Options: welded steel cap, 4" diameter pipe, no baseplate, galvanized
- Safety Yellow powder coat finish is standard, with other colors available upon request: orange, blue, black and grey
- Manufactured in 5-15 working days and shipped from TX.
- Standard models stocked in CA, PA, GA and NC for quick shipment



PIPE GUARD Model PG

- Protect exposed pipes, conduits, ducts and downspouts from damage
- 36" tall, wall-mounted models are standard
- 3/16" thick steel
- Designed for pipe diameters from 2" to 12"
- Hardware not included
- Options: floor, column or corner mounted, flat front
- Worksheet available for unique applications
- Safety Yellow powder coat finish is standard, with other colors available upon request: orange, blue, black and grey
- Manufactured in 5-15 working days and shipped from TX

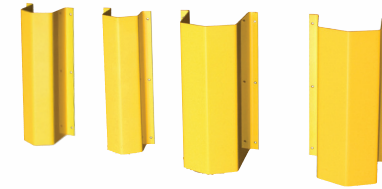

WAREHOUSE SAFETY



BUILDING COLUMN GUARDS Model BCG

- Protect building columns from damage
- Standard models are 42" tall, floor-mounted
- 3/16" or 1/4" thick steel
- Designed for column sizes from 4" to 24"
- Rated to withstand forklift impact of up to 10,000 lbs at 6 mph
- Shipped in two pieces – fasteners included for assembly
- Floor anchors not included
- Safety Yellow powder coat finish is standard, with other colors available upon request: orange, blue, black and grey
- Manufactured in 5-15 working days and shipped from TX



GOAL POST Model DGPP

- Protects overhead doorways from damage
- Available in 4" or 6" square tubing options
- Standard models protect up to 12' x 12' doors
- Fasteners included for assembly
- Offset baseplates provide more service area
- Anchoring hardware not included
- Safety Yellow powder coat finish is standard, with other colors available upon request: orange, blue, black and grey
- Options: core drilled posts, custom sizes
- Manufactured in 5-15 working days and shipped from TX

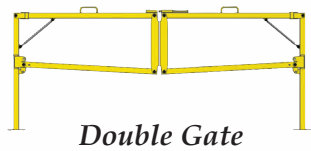

Double Gate



Single Gate

BARRIER GATES Models PBG

- Protective barrier for loading docks
- Pedestrian gate meets load criteria specified by OSHA which requires that it support a 200 lb concentrated load in any direction or a distributed load of 50 lbs per foot
- Anchors not included
- 42" height
- Designed for 8' to 12' door widths
- Options: single or double gate for 8' model
- Safety Yellow powder coat finish is standard, with other colors available upon request: orange, blue, black and grey
- Manufactured in 5-15 working days and shipped from TX



CORNER GUARD Model CG

- Protect wall or rack corners from damage
- Standard heights are 12", 18" and 24"
- Steel thickness options are 1/4", 3/8" and 1/2"
- 5"x5" angle size
- Anchors not included
- Options: larger angle size, custom heights
- Safety Yellow powder coat finish is standard, with other colors available upon request: orange, blue, black and grey
- Manufactured in 5-15 working days and shipped from TX

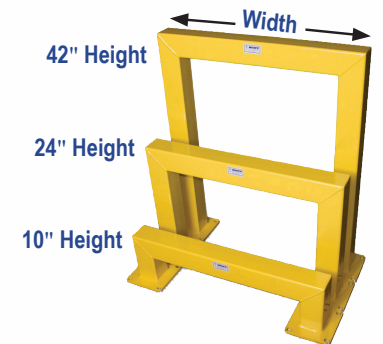

MACHINE GUARD Model MG

- Protect warehouse machinery from damage
- Standard heights of 10", 24" and 42"
- Standard widths of 36" or 48"
- Rated to withstand forklift impact of up to 10,000 lbs at 6 mph
- 4" square tubing models come with 1/2" x 8" x 8" baseplates
- 5" square tubing models come with 1/2" x 10" x 10" baseplates
- Anchors not included
- Options: custom sizes
- Safety Yellow powder coat finish is standard, with other colors available upon request: orange, blue, black and grey
- Manufactured in 5-15 working days and shipped from TX

MEZZANINES & GATES



- Non-welded bolt connections and flexibility of design for future modifications, relocation and/or expansion and potential reconfiguration at a later date
- Equipment and machinery mounting options available; multi-tiered integration of existing structures
- Maximization of vertical clearance for exceptional under-mezzanine space utilization
- High quality design and standardization of components to keep installation costs down
- Built to last and backed with a 30-year structural warranty
- Optional: gates, drop plates, stairways and landings, ships and caged ladders, conveyor support and vertical conveyor crossovers

MEZZANINE

Bluff's Mezzanines are an economical solution for freeing up floor space while providing expanded storage capacity. Easily create in-plant offices, observation platforms, personnel break rooms, extra storage areas, conveyor support structures or catwalks.

MEZZANINE GATES

Add a gate to any mezzanine to increase safety and accessibility.

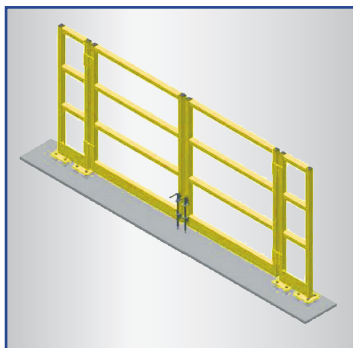

Slide Gate

- Standard widths from 5' to 8'
- Designed to fit new or existing railing
- Durable powder coat finish
- Adheres to industry standards

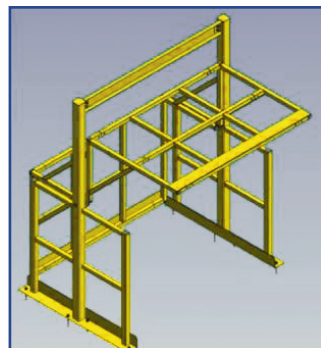

Pivot Gate

- Standard widths from 5' to 10'
- When mezzanine side is open, warehouse side is closed (and vice versa)
- Durable powder coat finish
- Adheres to industry standards

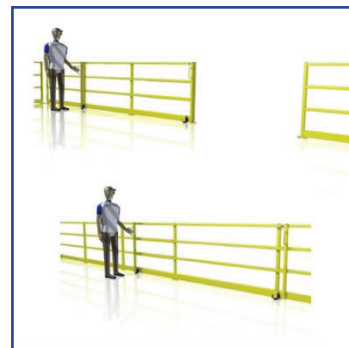

Swing Gate

- Standard widths from 3' to 10'
- Designed to fit new or existing railing
- Single or double panel swing
- Self-closing hinges included
- Durable powder coat finish
- Adheres to industry standards

OTHER STEEL STRUCTURES



OSHA Model

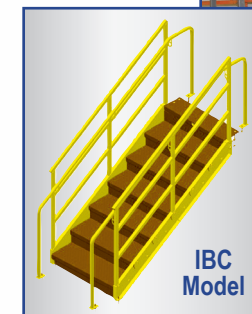

IBC Model

STAIRWAYS, LANDINGS & LADDERS

Bluff's Stairways, Landings & Ladders are designed and manufactured to meet specific application requirements, and are engineered with value and code compliancy in mind. Stairways can be integrated with landings, mezzanines, work platforms, conveyor crossovers or towers - IBC and OSHA models available. Fixed, Caged and Ships Ladders can also be added on for a safe, quick access point.

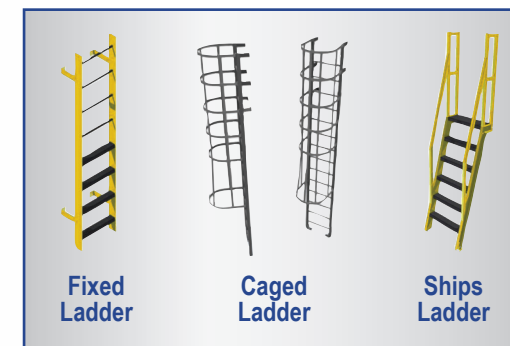

Fixed Ladder

Caged Ladder

Ships Ladder

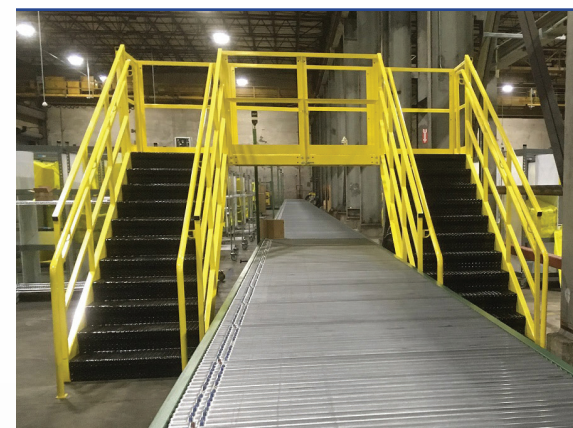

CONVEYOR CROSSOVERS

Bluff Conveyor Crossovers are designed to allow personnel to safely cross over active conveyors at designated and approved locations, significantly reducing the potential for worker injury and dramatically enhancing the efficiency of work flow.



CANTILEVER RACKS



CANTILEVER RACKS

Bluff Manufacturing's Cantilever Racks maximize space both vertically and horizontally to provide you with an economical, efficient storage and retrieval system. In addition, our all-structural steel fabrication ensures a long life for your storage investment.

- Minimize footprint of storage space while maximizing vertical and horizontal space density usage
- Capitalize on the higher lifting capacity and operational capability of current lifting equipment

- Avoid the expense of product loss/ damage through bypassing the pile-up method of on-the-floor storage and stacking
- Reduce handling time and enhance efficiency of inventory control/management through improved accessibility to storage space
- Economy of saving increases significantly as load length, height and bulkiness increases
- Simple installation, low maintenance and rugged operation increase the life of your cantilever racks

CARTS, STORAGE & HANDLING



PACKING BOX RACK

- Efficient design to meet box storage needs
- Custom compartments in a wide range of sizes
- Helps prevent damage to cartons
- Made to promote ergonomic pick-and-pull of boxes and cartons
- Durable power coat finish



ORDER PICKER CART

- Designed to attach to existing order picker
- Worksheet required for base design
- 1,000 lb load capacity
- Made of 5/16" steel diamond plate ; sides expanded steel; welded steel tow hook
- 54" wide x 60" long x 42" high
- 688 lbs
- Standard safety yellow color – custom colors available
- Comes with hand holes, pallet clamps, bolted wood

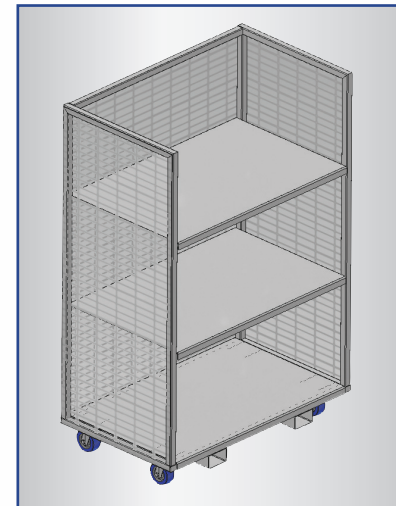

Order Picking Cart

CUSTOM CARTS

- Bluff's Custom Cart offering brings a sense of ease and efficiency to order fulfillment processes. They can also be designed to aid with transferring goods – i.e. furniture, packages, etc. – to displaying products, implementing FIFO or creating a portable workstation.
- Optimizes order picking and increases product flow
 - Customizable shelving and compartments



Furniture Cart



A-Frame Cart

- Varying capacities available based on application requirements
- Castor wheels included – custom options available
- Cart base can be customized to accommodate any type of portability requirement
- Worksheet required

OTHER STORAGE & HANDLING



KEG FLOW Model KEGFLOW

- Installs into existing pallet racks to provide faster and easier handling of craft kegs
- Available in all-welded or variable width designs
- Welded model fits up to 120" deep pallet racks
- Variable Width model fit up to 60" pallet racks
- Powder coated safety orange – other colors available
- Worksheet required



AFRAMESTD



AFRAMETRUCK

SLAB HANDLING EQUIPMENT

- Designed for storage and portability of granite slabs, either in a warehouse or on a delivery vehicle
- Model AFRAMESTD works for display & storage of slabs
- Model AFRAMETRUCK allows for vehicle transportation of slabs
- Options: single-sided wall display rack, fully-enclosed showroom display rack, slab handling fork extensions (worksheet required)



WINE FLOW Model WINEBOTTLE

- Designed to fit into existing 42" deep pallet racks
- Gravity-fed solution for storing and picking individual bottles
- 3 sizes available – Narrow, Mid and Wide
- Works with up to 4-1/8" diameter bottles (larger than Magnum)
- Fully welded construction
- Powder coated safety orange – other colors available
- Worksheet Required



SHEET ROCK DOLLY Model SRD

- Easily transport sheet rock, drywall, paneling, plywood, etc
- Load capacity 2,000 lbs
- Angled deck prevents slippage and provides optimal transportation of materials
- Indented back and open frame design for turns around tight corners
- Rounded corners to prevent product or wall damage
- Top grade steel construction
- Weighs 100 lbs when fully assembled
- Comes standard with 8" heavy duty mold-on rubber casters (2 fixed, 2 swivel)
- Optional – without casters
- Powder coated blue, with other standard colors available
- Manufactured in 7 working days and shipped from TX



CUSTOM PRODUCTS



Wheel Guides

Slab Display Rack



Prisoner Bench

Rail Bridge

Security Gate



Pipe Rack

Outside Crossover

FAST NATIONWIDE DELIVERY

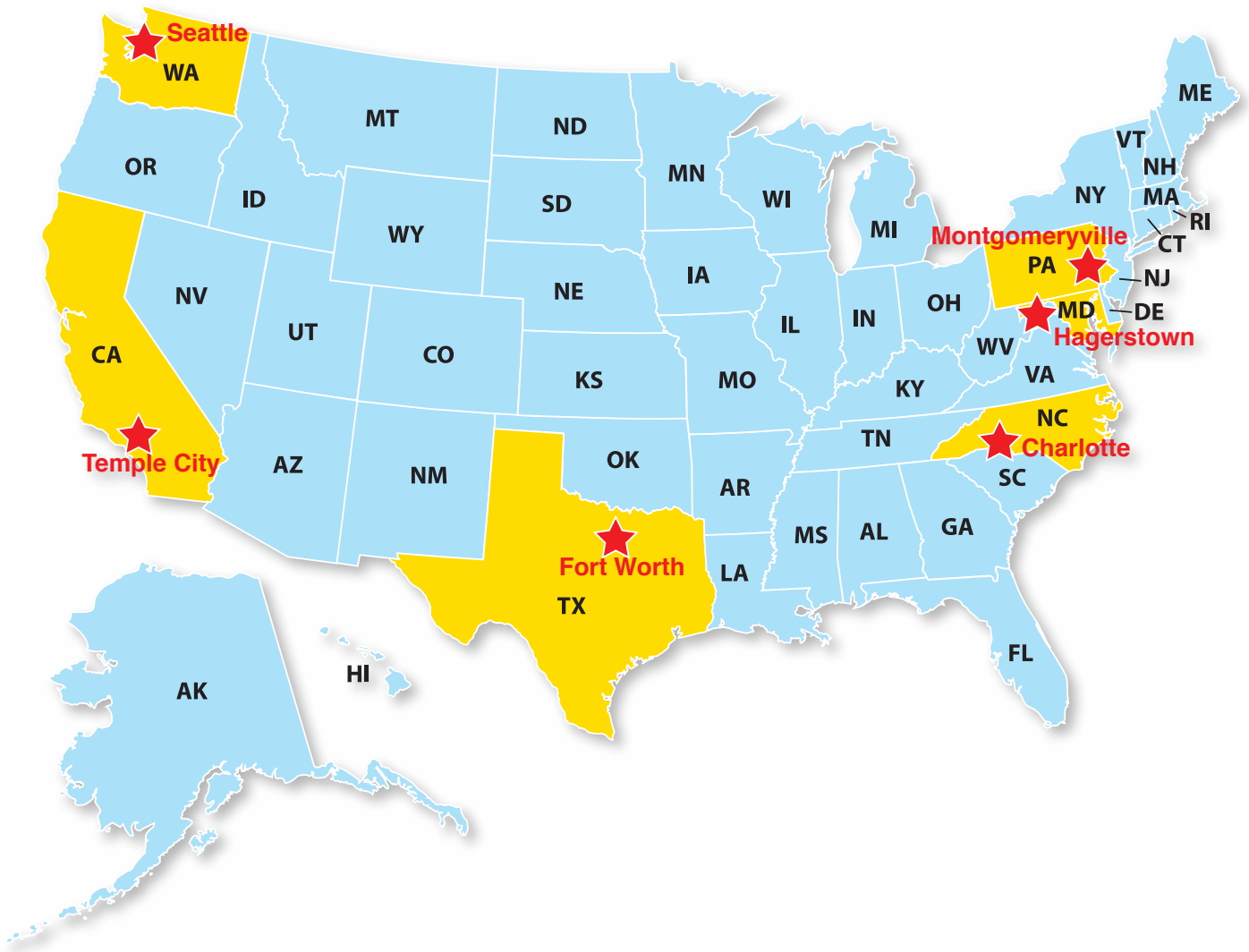

Bluff Manufacturing is committed to delivering high quality products based on a speedy timeline, and backed by unmatched customer service. We know time is money!

- 6 distribution facilities across the U.S. for next day pick up or shipping
- Aluminum Dock Boards and Plates manufactured and shipped within 1 day from Texas
- 99.5% on time shipping history
- Custom products engineered within 48 hours
- Sales Support and Customer Service team available for 10 hours a day, Monday through Friday

