

# Cotterman® CAL-OSHA rolling metal ladders

FOR OVER 80 YEARS COTTERMAN HAS BEEN  
MANUFACTURING A COMPLETE LINE OF HIGH QUALITY  
ROLLING STEEL LADDERS AND WORK PLATFORMS



 POWDER  
COATED  
TOUGH™

# Cotterman®

### WARRANTY

All Cotterman products are guaranteed against defects in workmanship and materials for a period of one (1) year after shipment.

DISTRIBUTED BY:

**w.w.Cannon, Inc.**

Design. Layout. Build. Install.

1-800-442-3061

[www.wwcannon.com](http://www.wwcannon.com)

COTTERMAN COMPANY  
IS PROUD TO BE A  
MEMBER OF THE FOLLOWING  
ASSOCIATIONS:



MEMBER  
**ANSI**



**MHIA**  
The Metal Hoisting Industry of America  
MEMBER COMPANY

# Cotterman®

**POWDER  
COATED  
TOUGH™**

**COTTERMAN SERIES 1000 LADDERS** are rigid, one piece, set-up, steel mobile ladder stands designed to meet OSHA standards. Safety is foremost with easy climbing angles, sturdy handrails, and large steps and top steps of slip-resistant expanded metal. Caster assemblies are designed to secure the ladder to the floor when in use, and to permit easy rolling from job to job.

## FEATURES:

- All tube members are large 1" O.D. smooth steel tubing.
- Climbing angles are 59°. Steps are 7" deep of durable, self-cleaning expanded metal. Top steps are 10", 20" or 30" deep.
- Spring loaded 2" casters are used on 1 to 4 step ladders permitting the ladder to roll freely when moved. The Cotterman Safe-Lock is used on 5 to 11 step ladders.
- Gray powder coat is the standard finish. Beige, dark brown, yellow, black, green, blue, red, white, orange and light gray are available.
- All Series 1000 ladders meet or exceed OSHA 1910 Subpart D, ANSI A14.7 and CAL-OSHA Title 8 Article 23 standards.
- 450 lb. load rating.

**COTTERMAN SERIES 1500** steel safety ladders are shipped knocked down in major welded subassemblies to save freight. Cotterman's exclusive knocked down design, incorporating diagonal braces together with heavy duty hardware, gives an unusually rigid structure that is easily assembled.

## FEATURES:

- 3 and 4 step ladders are equipped with spring loaded 2" ball bearing swivel casters.
- 5 to 12 step ladders have the Cotterman Safe-Lock.
- 13 to 16 step ladders are equipped with the Cotterman heavy duty Safe-Lock. The expanded metal top step is 10" deep with 42" high guardrails with midrails.
- Series 1500 ladders comply with OSHA 1910 Subpart D, ANSI A14.7 and CAL-OSHA Title 8 Article 23 standards.
- 450 lb. load rating.

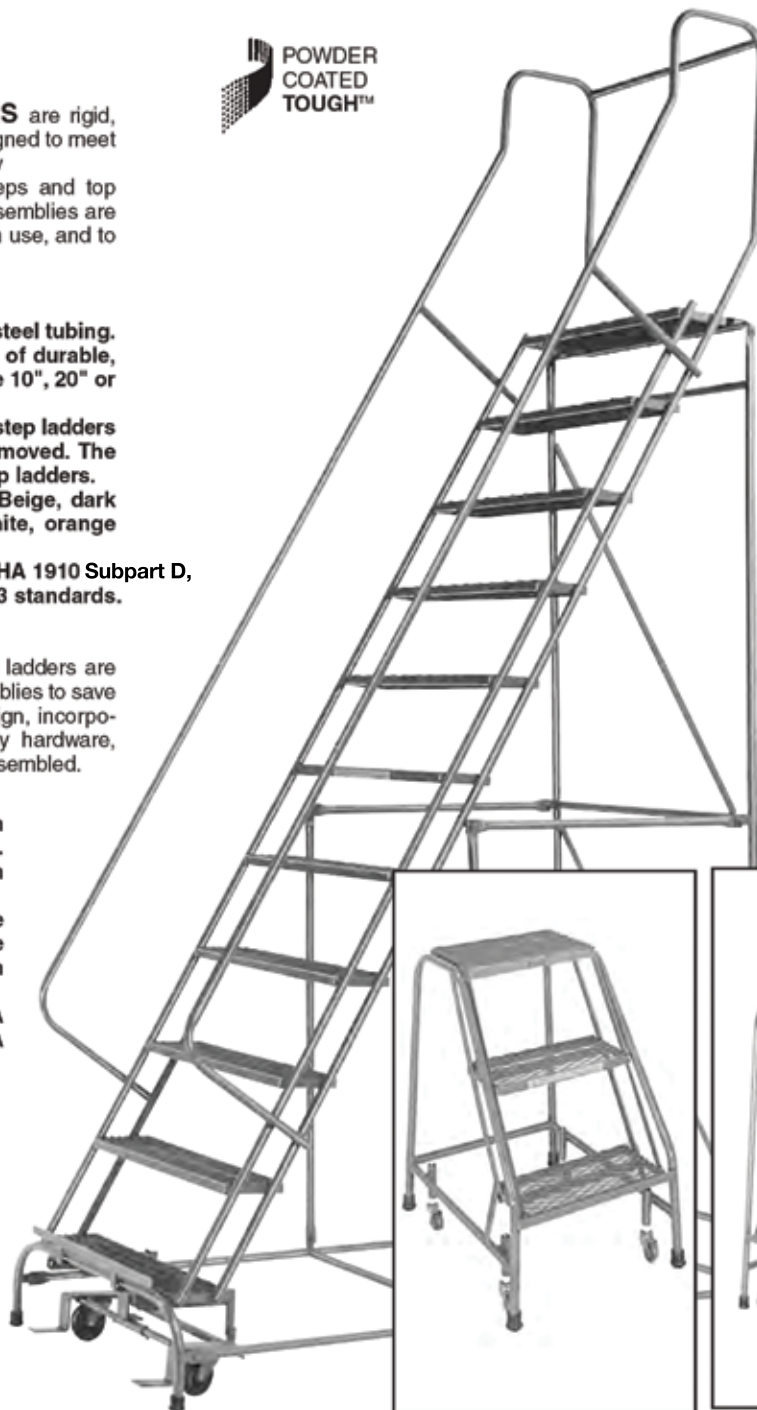
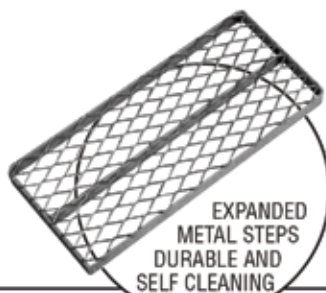

## HOW SAFE-LOCK WORKS!

Standard on 5-16 step ladders



- (A) Stepping on bottom step lowers trip bar, drops front leg to floor to immobilize ladder.  
 (B) Stepping on either pedal resets spring-return trip bar, places Safe-Lock in rolling position.  
 (C) Two 4" heavy-duty casters assure stability in motion.  
 (D) Rubber tips are metal reinforced for longer wear.

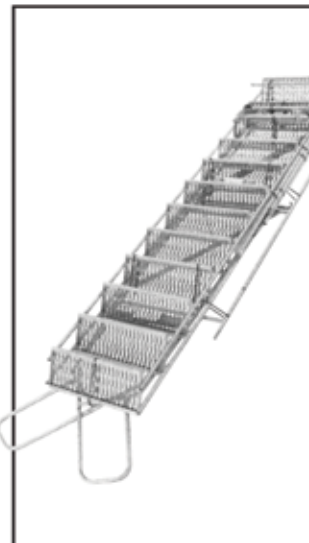
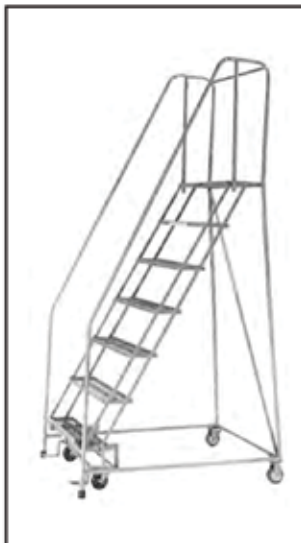



# SERIES 1000

## CAL-OSHA WELDED STEEL SAFETY LADDERS

Larger Casters & Safe-Lock on 5 step & above • Swivel Brake Casters standard on 1-4 step.

### SET-UP

DESCRIPTION: NO. OF STEPS INCL. TOP PLATFORM	TOP STEP HEIGHT	OVERALL HEIGHT	18" WIDE AT TOP				26" WIDE AT TOP				32" WIDE AT TOP			
			MODEL NO.	BASE W"xL"	SHPG. WT.	PRICE	MODEL NO.	BASE W"xL"	SHPG. WT.	PRICE	MODEL NO.	BASE W"xL"	SHPG. WT.	PRICE
1 STEP NO HANDRAILS	12"	12"	1001N1818	18x16	18		1001N2626	26x16	24		-	-	-	
1 STEP WITH HANDRAILS	12"	16"	1001G1818	18x16	19		1001G2626	26x16	26		-	-	-	
2 STEP NO HANDRAILS	20"	20"	1002N1818	18x19	25		1002N2626	26x19	29		-	-	-	
2 STEP WITH HANDRAILS	20"	50"	1002R1818	18x19	37		1002R2626	26x19	36		-	-	-	
3 STEP NO HANDRAILS	30"	30"	1003N1820	20x26	41		1003N2630	30x26	42		-	-	-	
3 STEP WITH HANDRAILS	30"	60"	1003R1820	20x26	43		1003R2630	30x26	50		-	-	-	
4 STEP WITH HANDRAILS	40"	70"	1004R1820	20x31	53		1004R2630	30x31	58		**1004R3232	32x31	74	
5 STEP WITH GUARDRAILS	50"	92"	1005R1820CO	20x40	86		1005R2630CO	30x40	103		1005R3232CO	32x40	118	
6 STEP WITH GUARDRAILS	60"	102"	1006R1824CO	24x46	99		1006R2630CO	30x46	114		1006R3232CO	32x46	133	
7 STEP WITH GUARDRAILS	70"	112"	1007R1824CO	24x53	110		1007R2630CO	30x53	126		1007R3232CO	32x53	148	
8 STEP WITH GUARDRAILS	80"	122"	-	-	-		1008R2632CO	32x58	159		1008R3232CO	32x58	185	
9 STEP WITH GUARDRAILS	90"	132"	-	-	-		1009R2632CO	32x65	172		1009R3232CO	32x65	201	
10 STEP WITH GUARDRAILS	100"	142"	-	-	-		1010R2642CO	42x72	188		1010R3242CO	42x72	220	
11 STEP WITH GUARDRAILS	110"	152"	-	-	-		1011R2642CO	42x78	203		1011R3242CO	42x78	238	

NOTE: 10 and 11 step ladders are not available with optional 20" or 30" deep platforms, please order 1500 series ladder.

\*\*4 step 32" wide (with deep platform only) ladders require B4 safe-lock option - add to price.

# SERIES 1500

## CAL-OSHA KNOCKED-DOWN STEEL SAFETY LADDERS

Larger Casters & Safe-Lock on 5 step & above • Swivel Brake Casters standard on 3-4 step.

### KNOCKED-DOWN

DESCRIPTION: NO. OF STEPS INCL. TOP STEP	TOP STEP HEIGHT	OVERALL HEIGHT	18" WIDE AT TOP				26" WIDE AT TOP				32" WIDE AT TOP			
			MODEL NO.	BASE W"xL"	SHPG. WT.	PRICE	MODEL NO.	BASE W"xL"	SHPG. WT.	PRICE	MODEL NO.	BASE W"xL"	SHPG. WT.	PRICE
3 STEP WITH HANDRAILS	30"	60"	*1503R1820	20x26	52		*1503R2630	30x26	60		-	-	-	
4 STEP WITH HANDRAILS	40"	70"	*1504R1820	20x33	61		1504R2630	30x33	71		**1504R3232	32x33	86	
5 STEP WITH GUARDRAILS	50"	92"	1505R1820CO	20x40	99		1505R2630CO	30x40	114		1505R3232CO	32x40	131	
6 STEP WITH GUARDRAILS	60"	102"	1506R1824CO	24x46	116		1506R2630CO	30x46	132		1506R3232CO	32x46	152	
7 STEP WITH GUARDRAILS	70"	112"	1507R1824CO	24x53	126		1507R2630CO	30x53	143		1507R3232CO	32x53	167	
8 STEP WITH GUARDRAILS	80"	122"	-	-	-		1508R2632CO	32x58	167		1508R3232CO	32x58	192	
9 STEP WITH GUARDRAILS	90"	132"	-	-	-		1509R2632CO	32x65	179		1509R3232CO	32x65	208	
*Shippable via UPS at additional packaging cost														
10 STEP WITH HANDRAILS	100"	142"	-	-	-		1510R2642CO	42x72	196		1510R3242CO	42x72	227	
11 STEP WITH HANDRAILS	110"	152"	-	-	-		1511R2642CO	42x78	212		1511R3242CO	42x78	247	
12 STEP WITH GUARDRAILS	120"	162"	-	-	-		1512R2642CO	42x88	302		1512R3242CO	42x88	358	
13 STEP WITH GUARDRAILS	130"	172"	-	-	-		1513R2648CO	48x95	340		1513R3248CO	48x95	391	
14 STEP WITH GUARDRAILS	140"	182"	-	-	-		1514R2648CO	48x101	360		1514R3248CO	48x101	436	
15 STEP WITH GUARDRAILS	150"	192"	-	-	-		1515R2654CO	54x108	382		1515R3254CO	54x108	462	
16 STEP WITH GUARDRAILS	160"	202"	-	-	-		1516R2654CO	54x114	426		1516R3254CO	54x114	489	

12 thru 16 step ladders are palletized to protect against freight damage. Add net per step to ladder price. \*\*4 step 32" wide (with deep platform only) ladders require B4 safe-lock option-add to price.

# OPTIONS

TO MODIFY AND INCREASE YOUR VERSATILITY

INCREASES LADDER  
MANEUVERABILITY  
TURNS CORNERS EASIER

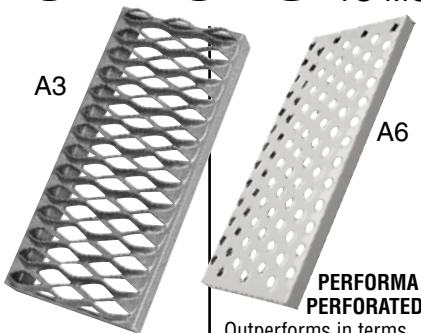

**A3 GRIP STRUT**  
Heavy duty, most rugged self-cleaning step available. **Option A3** add 20% to price of ladder.

**A6 PERFORMA PERFORATED**  
Outperforms in terms of slip resistance all other designs presently on the market. Available on ladders 18" and 26" wide. **Option A6** for no additional charge.

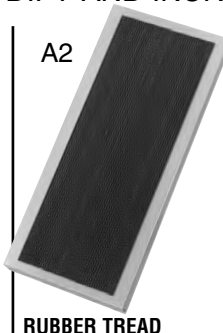

**A2 RUBBER TREAD**  
Solid metal step with non-slip ribbed rubber tread. Designed for use in offices. **Option A2** add 30% to price of ladder.

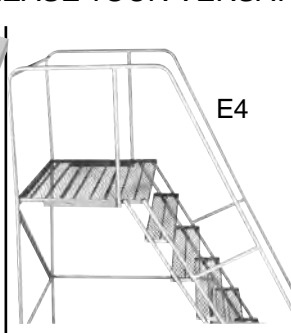

**E4 DEEPER TOP STEP**  
20" deep, 1-5 step  
30" deep, 1-5 step  
20" deep, 6-16 step  
30" deep, 6-16 step  
order **option E4**

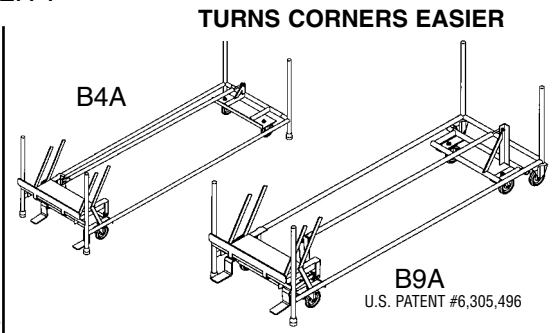

**B4A FOUR WHEEL DUAL END SAFE-LOCK:** This safe-lock uses rear mounted swivel casters which allow the ladder to be more maneuverable in confined spaces. Optional on series 1000. 5 to 8 step... add to price.

**B9A SIX WHEEL SAFE-LOCK FOR LARGER LADDERS:** This safe-lock system adds another pair of swivel casters to allow easy movement around corners. Available on 9 to 16 step models, add to price.

**B9A**  
U.S. PATENT #6,305,496



# Cotterman®

**COTTERMAN SERIES 2600** is a superior line of knocked down steel safety ladders. Designed and constructed for extra heavy duty use, these ladders have extra bracing and heavier materials to resist damage. They are offered in 9-15 step sizes and are shipped knocked down and palletized for safe handling.

## NEW HEAVY DUTY DAMAGE RESISTANT LADDERS

Easy **50**

### FEATURES:

- 800 lb. load rating.
- Larger 1 1/4" o.d. tubular base and back.
- 7" steps and 11 3/4" top step available in three tread types.
- Ladders are provided with the Cotterman heavy duty Safe-Lock caster system.
- Gray powder coat is the standard finish. Beige, dark brown, yellow, black, green, blue, red, white, orange and light gray are available.
- The Series 2600 meets or exceeds OSHA 1910 Subpart D, ANSI A14.7. CAL-OSHA Title 8 Article 23.

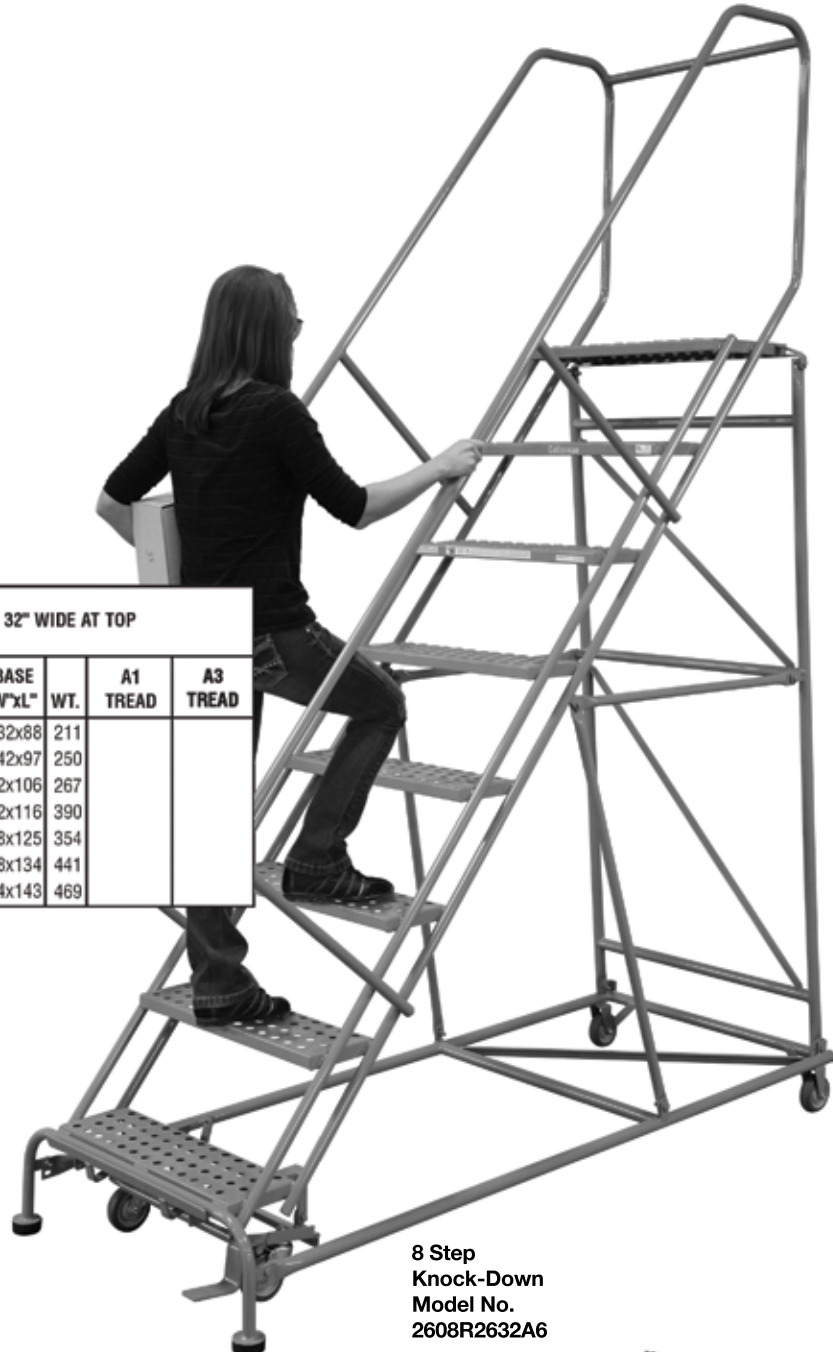

8 Step  
Knock-Down  
Model No.  
2608R2632A6

## HEAVY DUTY KNOCK-DOWN SERIES 2600

DESCRIPTION: NO. OF STEPS INCL. TOP STEP	PLAT. HEIGHT	OVERALL HT.	26" WIDE AT TOP				32" WIDE AT TOP					
			MODEL NO.	BASE W"xL"	WT.	A1 TREAD	A3 TREAD	MODEL NO.	BASE W"xL"	WT.	A1 TREAD	A3 TREAD
9 HANDRAILS	90"	132"	2609R2632	32x88	199			2609R3232	32x88	211		
10 HANDRAILS	100"	142"	2610R2642	42x97	217			2610R3242	42x97	250		
11 HANDRAILS	110"	152"	2611R2642	42x106	231			2611R3242	42x106	267		
12 GUARDRAILS	120"	162"	2612R2642	42x116	333			2612R3242	42x116	390		
13 GUARDRAILS	130"	172"	2613R2648	48x125	354			2613R3248	48x125	354		
14 GUARDRAILS	140"	182"	2614R2648	48x134	375			2614R3248	48x134	441		
15 GUARDRAILS	150"	192"	2615R2654	54x143	398			2615R3254	54x143	469		

NOTE: 12 thru 15 step ladders are palletized to protect against freight damage - Add \$ net to ladder price.

### EXCLUSIVE HEAVY DUTY SAFE-LOCK



KNOCKED-DOWN AND  
PALLETIZED FOR  
SECURE FREIGHT

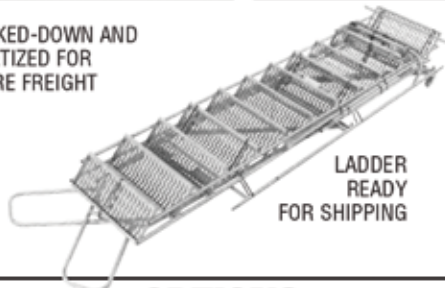

POWDER  
COATED  
TOUGH™

### OPTIONS

**E4**  
24" DEEP  
TOP STEP

**A1**  
EXPANDED  
METAL  
STEPS  
durable  
and self  
cleaning.

**A3**  
GRIP STRUT  
Heavy duty,  
most rugged self-  
cleaning step  
available.

**A6**  
PERFORMA  
PERFORATED  
Available on lad-  
ders 18" and 26"  
wide. **Option A6**  
for no additional  
charge.

# Cotterman® SERIES 6500

WELDED STEEL ROLL-N-FOLD LADDER

MODEL NO.  
6507R1830A3



**THE COTTERMAN SERIES 6500 ROLL-N-FOLD LADDER** is a portable steel safety ladder that can be folded for transporting. The rear of the ladder has large 10" diameter solid rubber wheels allowing it to roll easily. Large rubber pads on the front legs hold the ladder secure during use. The ladder is moved by tilting and rolling it like a wheelbarrow. The optional Safe-Lock added to the step side provides greater mobility while set-up.

**FEATURES:**

- Rigid 1" O.D. tubular frame is designed to be folded.
- Large 10" diameter ball bearing solid rubber wheels are mounted on heavy 3/4" axles.
- Treads are 7" deep and 16" wide, and are available in A1 expanded metal or A3 Grip Strut. The standard top step is 10" deep and 16" wide, and E4-20 is 20" deep and 16" wide.
- Gray powder coat is the standard finish. Beige, dark brown, yellow or black are available
- Series 6500 ladders comply with OSHA 1910 Subpart D, ANSI A14.7 and CAL-OSHA Title 8 Article 23 standards.
- 450 lb. load rating.
- Safelock standard on 10-16 steps.

NO. STEPS INCL. TOP STEP	TOP STEP HEIGHT	OVERALL HEIGHT W/RAILS	BASE W"xL"	APPR. FOLDED DIMENSIONS W"xL"xH"	SHPG. WT.	MODEL NO.	A1 TREAD	A1 TREAD W/E4-20	A3 TREAD	A3 TREAD W/ E4-20
5	50"	92"	30x46	32x86x24	100	6505R1830CO				
6	60"	102"	30x53	32x98x24	120	6506R1830CO				
7	70"	112"	30x58	32x110x24	131	6507R1830CO				
8	80"	122"	30x65	32x122x24	145	6508R1830CO				
9	90"	132"	30x72	32x134x24	157	6509R1830CO				
10	100"	142"	40x78	42x146x24	197	6510R1840CO				
11	110"	152"	40x86	42x158x24	202	6511R1840CO				
12	120"	162"	40x92	42x176x36	318	*6512R1840CO				
13	130"	172"	48x99	50x188x36	344	*6513R1848CO				
14	140"	182"	48x106	50x200x36	364	*6514R1848CO				
15	150"	192"	54x112	56x212x36	388	*6515R1854CO				
16	160"	202"	54x119	56x224x36	407	*6516R1854CO				

\*NOTE: 12 thru 16 step ladders are palletized to protect against freight damage - Add \$ to price.  
**OPTION B4**, Safe-Lock available on 5 to 9 step sizes, add \$ to price.



LARGE 10" DIA. SOLID RUBBER WHEELS

FOLDS FOR EASY TRANSPORTING

## STANDARD FEATURES AND OPTIONS

For ladders shown on pages 2, 3, 4 and 5

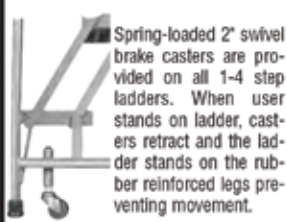

Spring-loaded 2" swivel brake casters are provided on all 1-4 step ladders. When user stands on ladder, casters retract and the ladder stands on the rubber reinforced legs preventing movement.

**OPTION B4 SAFE LOCK OPERATION**



A. Stepping on bottom stem lowers trip bar, drops rubber tipped legs to floor to immobilize ladder.  
 B. Stepping on either pedal resets spring-return trip bar, places 4" dia. safe-lock casters in rolling position.  
**OPTION B4:** Standard on 5 to 19 step, optional on 6500 series shown on pg. 5. . . . . add to price.

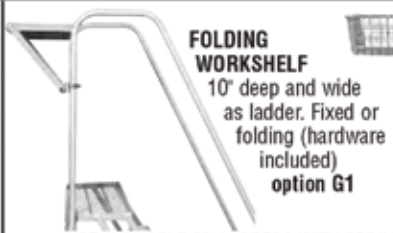

**FOLDING WORKSHELF**  
 10" deep and wide as ladder. Fixed or folding (hardware included)  
**option G1**



**WIRE BASKET**  
 Removable wire basket with hooks  
 (12"W x 18"L x 5"D).  
**option F1**

NOT AVAILABLE ON LADDERS WITH SPRING-LOADED CASTERS

### HOW TO SELECT THE PROPER LADDER

1. Select platform height based on operations to be performed or weight and bulk of objects to be carried. Maximum convenient working height is generally 5'0" to 6'0" above top step.
2. Particularly in the larger sizes, choose a wide ladder over a narrow one if space permits. For very bulky loads, consider a 32" wide ladder. Take into account whether people must pass ladder in aisle and where it must rest when not in use.
3. Consider limitations on ladder dimensions imposed by doorways, overhead obstructions, corners that ladders must turn, etc.
4. Baskets and shelves are available for resting or sorting merchandise while on the ladder.
5. Where aisles are narrow, consider narrow aisle ladders for easier maneuverability.
6. For unusual conditions not illustrated in this catalog, ask for suggestions and prices.

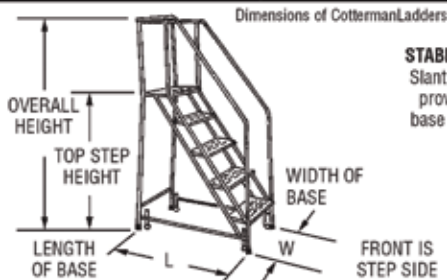

**STABLE DESIGN**  
 Slant leg design provides wider base for greater stability.

**REPLACEMENT PARTS**  
 2" caster box (complete for 1 ladder). . . . .  
 (ladder model required)  
 Rubber tips for 1" tubing. each. . . . .  
 Rubber pads, 2 1/2" each. . . . .

**WARRANTY**

All Cotterman products are guaranteed against defects in workmanship and materials for a period of one (1) year after shipment. At our discretion, Cotterman Company will repair or replace the product in question at no charge — subject to inspection. Freight damage, misapplication and misuse of the product are not covered by this warranty.

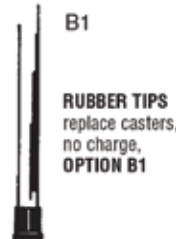

**RUBBER TIPS** replace casters, no charge, **OPTION B1**

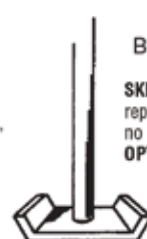

**SKID PLATES** replace casters, no charge, **OPTION B7**





Easy **50**

# WELDED STEEL WORK PLATFORMS

**THE COTTERMAN SERIES WP** one-piece set-up steel work platforms are designed for safe access to required work levels. WP work platforms are easily moved from job to job on the rear 4" rigid casters. For greater mobility, the optional Safe-Lock assembly can be specified. Easy 50° climbing angle.



### HEAVY DUTY FEATURES:

- 800 pound load rating.
- Complies with OSHA 1910 Subpart D, ANSI A 14.7 and CAL-OSHA Title 8 article 23 standards for use by one or two persons.
- Large 2 1/2" diameter, 1" thick rubber pads on the front legs hold the standard platform secure during use.
- Two 4" rigid heavy duty casters on the rear are standard. The optional Cotterman Safe-Lock on the step side provides greater mobility.
- Steps and platforms are constructed of heavy duty non-slip Grip Strut supported by a rugged 1" O.D. tubular frame. Special designs are available.
- Gray powder coat finish is standard color.
- Full 42" high guardrails are provided on 5 thru 7 step models. 30" handrails are standard on 4 step models and optional on 2 and 3 step models.

CAL-OSHA  
WELDED STEEL WORK PLATFORMS

## SERIES WP

NO. STEPS INCL. TOP PLATFORM	PLAT-FORM HT.	TYPE OF RAILS	PLAT-FORM WIDT	24" LONG PLATFORM				36" LONG PLATFORM				48" LONG PLATFORM				60" LONG PLATFORM			
				MODEL NO.	BASE W"xL"	WT.	PRICE	MODEL NO.	BASE W"xL"	WT.	PRICE	MODEL NO.	BASE W"xL"	WT.	PRICE	MODEL NO.	BASE W"xL"	WT.	PRICE
2	20"	NONE	24"	2WP2424	28x31	47		2WP2436	29x43	60		2WP2448	28x55	77		2WP2460	28x67	83	
2	20"	NONE	36"	2WP3624	40x31	62		2WP3636	40x43	80		2WP3648	40x55	104		2WP3660	40x67	122	
3	30"	NONE	24"	3WP2424	28x38	62		3WP2436	28x50	75		3WP2448	28x62	94		3WP2460	28x74	107	
3	30"	NONE	36"	3WP3624	40x38	81		3WP3636	40x50	98		3WP3648	40x62	125		3WP3660	40x74	143	
4	40"	HAND	24"	4WP2424R	28x45	87		4WP2436R	28x57	98		4WP2448R	28x69	124		4WP2460R	28x81	136	
4	40"	HAND	36"	4WP3624R	40x45	140		4WP3636R	40x57	127		4WP3648R	40x69	160		4WP3660R	40x81	177	
5	50"	GUARD	24"	5WP2424RCO	28x53	109		5WP2436RCO	28x64	122		5WP2448RCO	28x76	154		5WP2460RCO	28x88	167	
5	50"	GUARD	36"	5WP3624RCO	40x53	138		5WP3636RCO	40x64	156		5WP3648RCO	40x76	193		5WP3660RCO	40x88	212	
6	60"	GUARD	24"	6WP2424RCO	28x59	124		6WP2436RCO	28x71	137		6WP2448RCO	28x83	171		6WP2460RCO	28x95	186	
6	60"	GUARD	36"	6WP3624RCO	40x59	156		6WP3636RCO	40x71	175		6WP3648RCO	40x83	215		6WP3660RCO	40x95	235	
7	70"	GUARD	24"	7WP2424RCO	28x66	139		7WP2436RCO	28x78	152		7WP2448RCO	28x90	199		7WP2460RCO	28x102	210	
7	70"	GUARD	36"	7WP3624RCO	40x66	175		7WP3636RCO	40x78	193		7WP3648RCO	40x90	247		7WP3660RCO	40x102	263	

OPTION R - full 30" high handrails on 2 and 3 step ladders \$

OPTION B4 - Safe-Lock caster system under front step, 3 thru 7 step ladders \$

**POWDER  
COATED  
TOUGH™**

# Cotterman®

**COTTERMAN SERIES DWP** welded steel work platform provides dual entry access in a wide range of platform sizes. DWP work platforms are desirable in work areas that require quick, convenient, and efficient access to required work levels.

### HEAVY DUTY FEATURES:

- 800 pound load rating.
- Complies with OSHA 1910 Subpart D, ANSI A14.7 and CAL-OSHA Title 8 Article 23 standards for use by one or two persons.
- Steps and top platform are fabricated from heavy duty non-slip Grip Strut supported by a rugged 1" O.D. tubular frame. Special designs are available.
- All 3 and 4 step units have 36" high handrails. 5 thru 7 step models are provided with 42" guardrails. Rails are shipped knocked down for field assembly in minutes.
- Exclusive heavy duty Cotterman Safe-Lock is provided at both ends for mobility.
- 2 1/2" diameter, 1" thick rubber pads on four legs hold the platform secure during use.
- Gray powder coat finish is standard color.



EXCLUSIVE HEAVY DUTY  
SAFE-LOCK AT BOTH ENDS



STEPPING DOWN LOWERS TRIP  
BAR TO IMMOBILIZE LADDER



STEP ON EITHER PEDAL TO RESET  
SAFE-LOCK TO ROLLING POSITION



HEAVY DUTY NON-SLIP GRIP  
STRUT STEPS AND PLATFORM

## SERIES DWP

CAL-OSHA WELDED STEEL DOUBLE WORK PLATFORMS

NO. STEPS INCL. TOP PLATFORM	PLAT- FORM HT.	PLAT- FORM WIDTH	48" LONG PLATFORM				60" LONG PLATFORM				72" LONG PLATFORM				84" LONG PLATFORM					
			MODEL NO.	BASE W"xL"	WT.	PRICE	MODEL NO.	BASE W"xL"	WT.	PRICE	MODEL NO.	BASE W"xL"	WT.	PRICE	MODEL NO.	BASE W"xL"	WT.	PRICE		
3	30"	24"	3DWP2448RL	28x75	197			3DWP2460RL	28x87	218			3DWP2472RL	28x99	232			3DWP2484RL	28x111	197
3	30"	36"	3DWP3648RL	40x75	239			3DWP3660RL	40x87	267			3DWP3672RL	40x99	286			3DWP3684RL	40x111	314
4	40"	24"	4DWP2448RL	28x87	217			4DWP2460RL	28x99	244			4DWP2472RL	28x111	247			4DWP2484RL	28x123	279
4	40"	36"	4DWP3648RL	40x87	266			4DWP3660RL	40x99	298			4DWP3672RL	40x111	316			4DWP3684RL	40x123	347
5	50"	24"	5DWP2448RLCO	28x99	242			5DWP2460RLCO	28x111	269			5DWP2472RLCO	28x123	283			5DWP2484RLCO	28x135	311
5	50"	36"	5DWP3648RLCO	40x99	299			5DWP3660RLCO	40x111	333			5DWP3672RLCO	40x123	351			5DWP3684RLCO	40x135	386
6	60"	24"	6DWP2448RLCO	28x111	274			6DWP2460RLCO	28x123	308			6DWP2472RLCO	28x135	321			6DWP2484RLCO	28x147	357
6	60"	36"	6DWP3648RLCO	40x111	342			6DWP3660RLCO	40x123	379			6DWP3672RLCO	40x135	397			6DWP3684RLCO	40x147	435
7	70"	24"	7DWP2448RLCO	28x123	300			7DWP2460RLCO	28x135	333			7DWP2472RLCO	28x147	347			7DWP2484RLCO	28x159	380
7	70"	36"	7DWP3648RLCO	40x123	373			7DWP3660RLCO	40x135	412			7DWP3672RLCO	40x147	432			7DWP3684RLCO	40x159	471



# Cotterman®

**COTTERMAN ALUMINUM SERIES "A" SAFETY LADDERS** are one-piece set-up assemblies of high strength aluminum alloy. The solid ribbed aluminum steps and platform provide sure footing in areas where dress shoes or high heels are worn. In addition to being lightweight, aluminum ladders are corrosion resistant and easy to clean. They are also non-magnetic.



## FEATURES:

- The structural framework is of 1" O.D. 6061-T6 high strength aluminum alloy tube.
- Both the steps and the top platform are 16" or 24" wide and available in solid ribbed extruded aluminum alloy or aluminum grip strut. The steps are 7" deep. The platform is 14" deep.
- All ladders are provided with spring loaded 2" ball bearing swivel brake casters and reinforced rubber tipped legs.
- Ladders are normally furnished with unpainted aluminum mill finish.
- Series A aluminum ladders comply with OSHA 1910 Subpart D, ANSI A14.7 and CAL-OSHA Title 8 Article 23 standards.
- 350 lb. load rating.



6 STEP  
MODEL NO.  
A6R2630A4

## CAL-OSHA WELDED ALUMINUM SAFETY LADDERS **SERIES A**



**A4**

SOLID RIBBED ALUMINUM STEPS

**A3**

HEAVY DUTY ALUMINUM GRIP STRUT

NO. STEPS INCL. TOP STEP	TYPE OF RAILS	TOP STEP HT.	OVER-ALL HT.	18" WIDE AT TOP					26" WIDE AT TOP					
				MODEL NO.	BASE W"xL"	SHPG. WT.	A4 TREAD	A3 TREAD	MODEL NO.	BASE W"xL"	SHPG. WT.	A4 TREAD	A3 TREAD	
1	NONE	12"	12"	*A1N1818	18x20	13				*A1N2626	26x20	14		
2	NONE	20"	20"	*A2N1818	18x23	16				*A2N2626	26x23	20		
2	HAND	20"	50"	A2R1818	18x23	19				A2R2626	26x23	21		
3	NONE	30"	30"	A3N1822	22x29	21				A3N2630	30x29	25		
3	HAND	30"	60"	A3R1822	22x29	24				A3R2630	30x29	27		
4	HAND	40"	70"	A4R1822	22x36	28				A4R2630	30x36	32		
5	GUARD	50"	92"	A5R1822CO	22x43	36				A5R2630CO	30x43	40		
6	GUARD	60"	102"	A6R1824CO	22x50	41				A6R2630CO	30x50	46		
7	GUARD	70"	112"	-	-	-				A7R2630CO	30x57	56		
8	GUARD	80"	122"	-	-	-				A8R2630CO	30x63	63		

\*Shippable via UPS at additional boxing cost

COTTERMAN COMPANY IS PROUD TO BE A MEMBER OF THE FOLLOWING ASSOCIATIONS:

MEMBER **ANSI**

MEMBER **MHIA**  
The Material Handling Industry of America  
MEMBER COMPANY

MEMBER **SIA**  
SCAFFOLD INDUSTRY ASSOCIATION

MEMBER **National Safety Council**

**OPTIONS**

**RUBBER TIPPED LEGS** can be substituted for casters, no charge **B1**

**SKID PLATES** can be substituted for casters, no charge **B7**

# Cotterman®

800-442-3061

sales@wvcannon.com

2653 Brenner Dr. Dallas, TX 75220

wvcannon.com