



A Division of Systems, LLC



# PREMIUM LOADING DOCK SAFETY EQUIPMENT

# THE IMPORTANCE OF SAFETY

Several factors combine to threaten the safety of loading dock employees:

- Forklift drivers are often in a hurry and may drive too fast.
- Forklifts weigh four to five tons on average and often carry heavy loads.
- Large loads often obstruct a forklift driver's view.
- Using a forklift to load a trailer can sometimes push it away from the dock, causing the leveler lip to fall out of the trailer and creating a dangerous gap.
- A truck driver may prematurely pull away from the dock creating a dangerous gap.



**SAFETY** AT THE LOADING  
DOCK IS **VITAL**  
TO ANY SHIPPING AND RECEIVING  
OPERATION

OSHA requires at a minimum the use of wheel chocks to restrain trailers at loading docks. Unfortunately, wheel chocks are used infrequently and often improperly. Even when used properly, wheel chocks are not always effective at keeping a trailer at the dock. Sand, dirt, gravel, or precipitation of any kind can prevent wheel chocks from staying in place. A truck driver in a hurry can often pull a trailer right over the wheel chock and away from the dock.

A safer alternative are vehicle restraints, which satisfy the OSHA requirement and are far more effective than wheel chocks.

## MAKING THE CASE for Industry-Leading Vehicle Restraints by McGuire®

McGuire vehicle restraints are engineered to prevent a trailer from prematurely leaving the dock. They accomplish this by holding or blocking a trailer's Rear Impact Guard (RIG) to keep the trailer secured to the

dock. McGuire manufactures two types of restraints that use the RIG to restrain a trailer: non-impact vertical barrier and trailer-positioned rotating hooks.

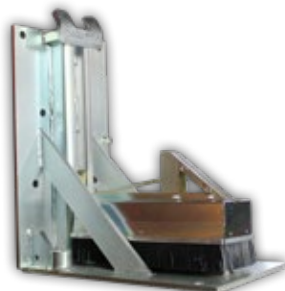

# LIGHT COMMUNICATION

McGuire is an industry leader in light communication, which plays a vital role in loading dock safety. It's the most common and reliable way for dock personnel and truck drivers to communicate.

A light communication system uses red/green lights outside the dock to tell truck drivers when it's safe for them to leave and lights on the controller inside the dock to tell dock personnel when it's safe to service a trailer.

All McGuire automatic vehicle restraints come equipped with iDock® Controls and advanced light communication. When vehicle restraints are not installed, this advanced light communication is also available with Dock Alert or iDock Alert.

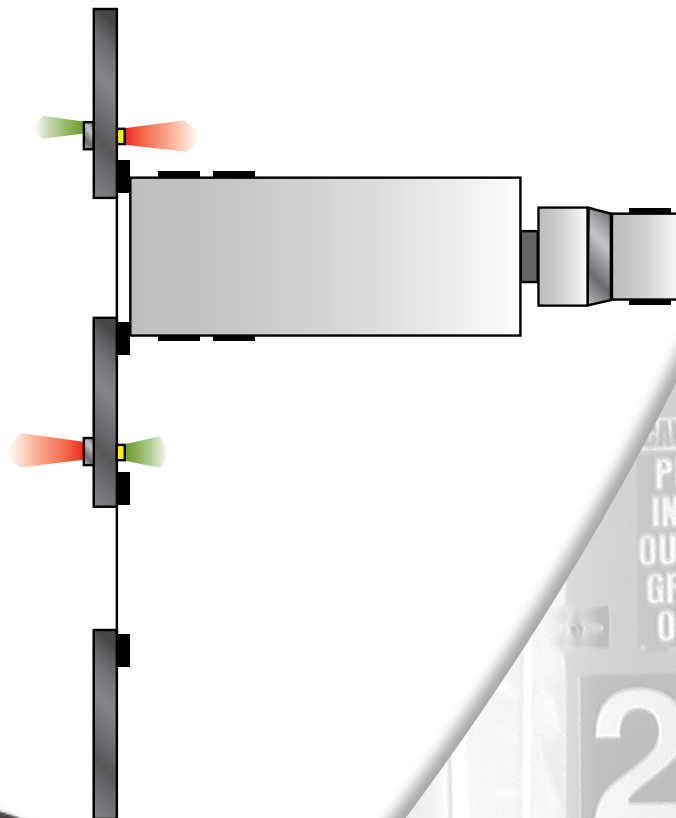

**Dock Alert**



**iDock® Alert**

A light communication system is a simple, reliable, and economical warning system that establishes a clear line of communication between truck drivers and dock personnel, helping to prevent accidents at the loading dock.

# UNICHOCK VEHICLE RESTRAINT

UniChock helps prevent early departure from the dock for vehicles that cannot be captured by wall or ground mounted restraints because they lack a usable rear impact guard.

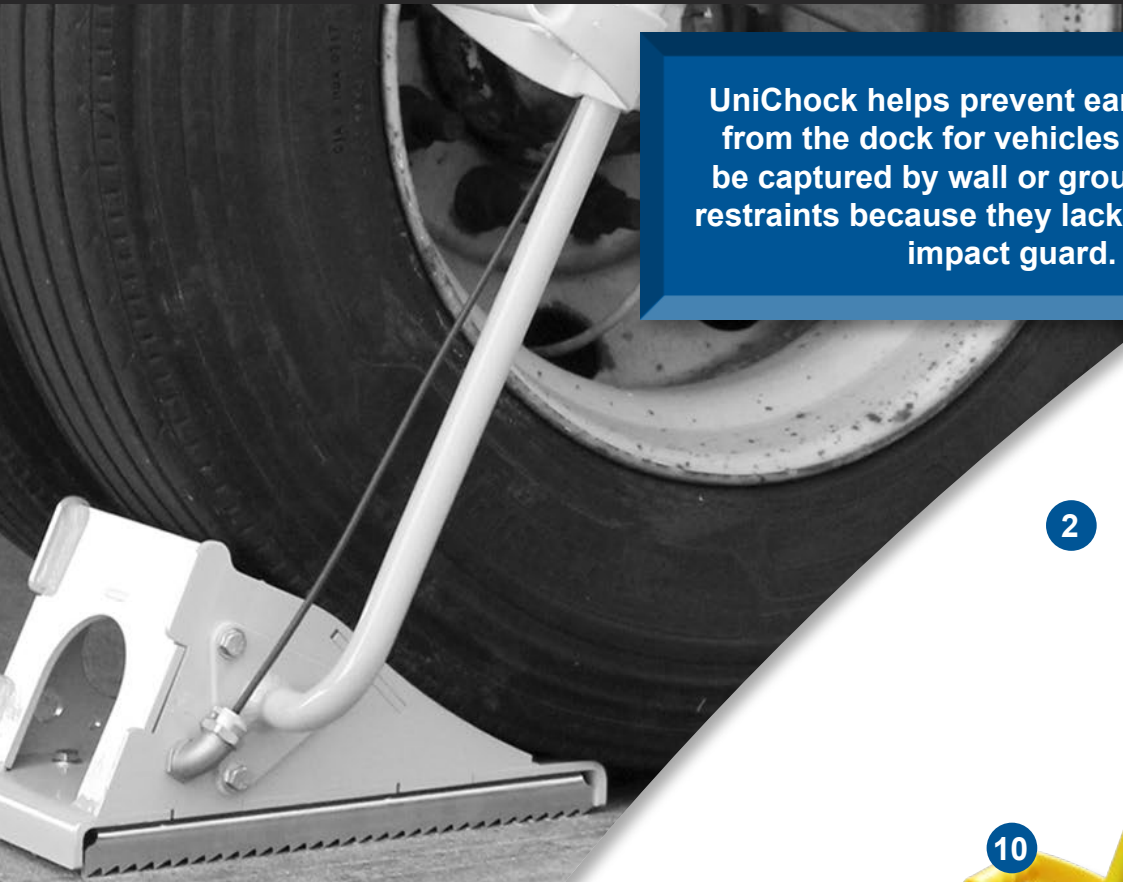

- 1 Universal Wheel Chock with Light Communication System
- 2 Audible Alerts to ensure safe use and storage
- 3 Interior messages for the position of the chock
- 4 iDock Alert with interactive message display
- 5 Adjustable handle
- 6 Yellow powder coat for high visibility
- 7 Strong grip to limit sliding
- 8 Zinc plated steel storage bracket
- 9 Replacable teeth for overall longevity
- 10 IP68 sensor rating for use in virtually any dock environment



# STOP-TITE<sup>®</sup> VEHICLE RESTRAINT

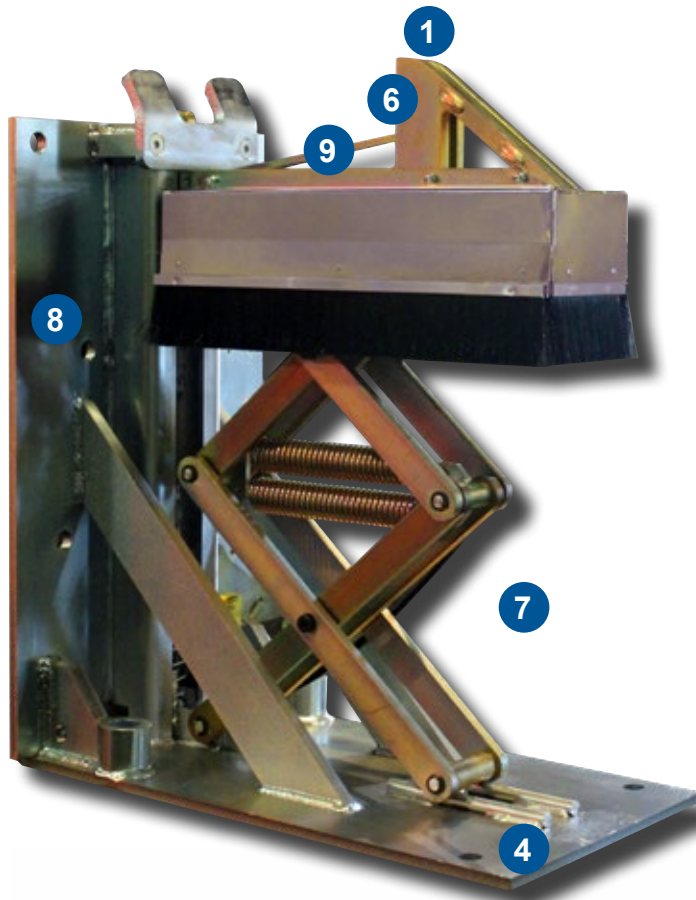

The PowerStop provides a reliable and economical solution to help prevent unexpected trailer departure from the loading dock during loading/unloading.

- 1 Non-impact vertical barrier
- 2 Manual or push-button activation
- 3 Manual or Auto Lights
- 4 Dock wall or ground mount
- 5 Restraining force in excess of 32,000 lbs.
- 6 Horizontal service range: 0" to 10" from the bumpers
- 7 Vertical service range: 12" to 29.5" off the ground
- 8 Corrosion resistant zinc-plated finish
- 9 Automatically ensures RIG capture or returns to stored position (push-button units only)



# TPR<sup>®</sup>

## VEHICLE RESTRAINT

The TPR is a trailer-positioned restraint that automatically adjusts to the height of a trailer's RIG and uses a rotating steel hook to secure the trailer to the dock during loading/unloading.

- 1 Trailer-positioned rotating hook
- 2 Push-button activation
- 3 Mounts to the dock wall
- 4 Restraining force in excess of 32,000 lbs.
- 5 Horizontal service range: 0" to 10" from the bumpers
- 6 Vertical service range: 9" to 30" off the ground
- 7 Corrosion resistant zinc-plated finish
- 8 Automatically ensures RIG capture or returns to stored position
- 9 IP67 rated motor is submersion proof in one meter of water for 30 minutes





# UNILOCK<sup>®</sup> VEHICLE RESTRAINT



UniLock is the only trailer-positioned rotating hook restraint that can automatically release "RIG Wedge" pressure, eliminating the need for the truck to reverse to release the trailer.

- 1 Trailer-positioned rotating hook
- 2 Push-button activation
- 3 Mounts to the dock wall
- 4 Restraining force in excess of 32,000 lbs.
- 5 Horizontal service range: 0" to 10" from the bumpers
- 6 Vertical service range: 9" to 30" off the ground
- 7 Corrosion resistant zinc-plated finish
- 8 Automatically ensures RIG capture or returns to stored position
- 9 IP67 rated motor is submersion proof in one meter of water for 30 minutes
- 10 Internal safety mechanism that locks the restraint hook when pressure is applied

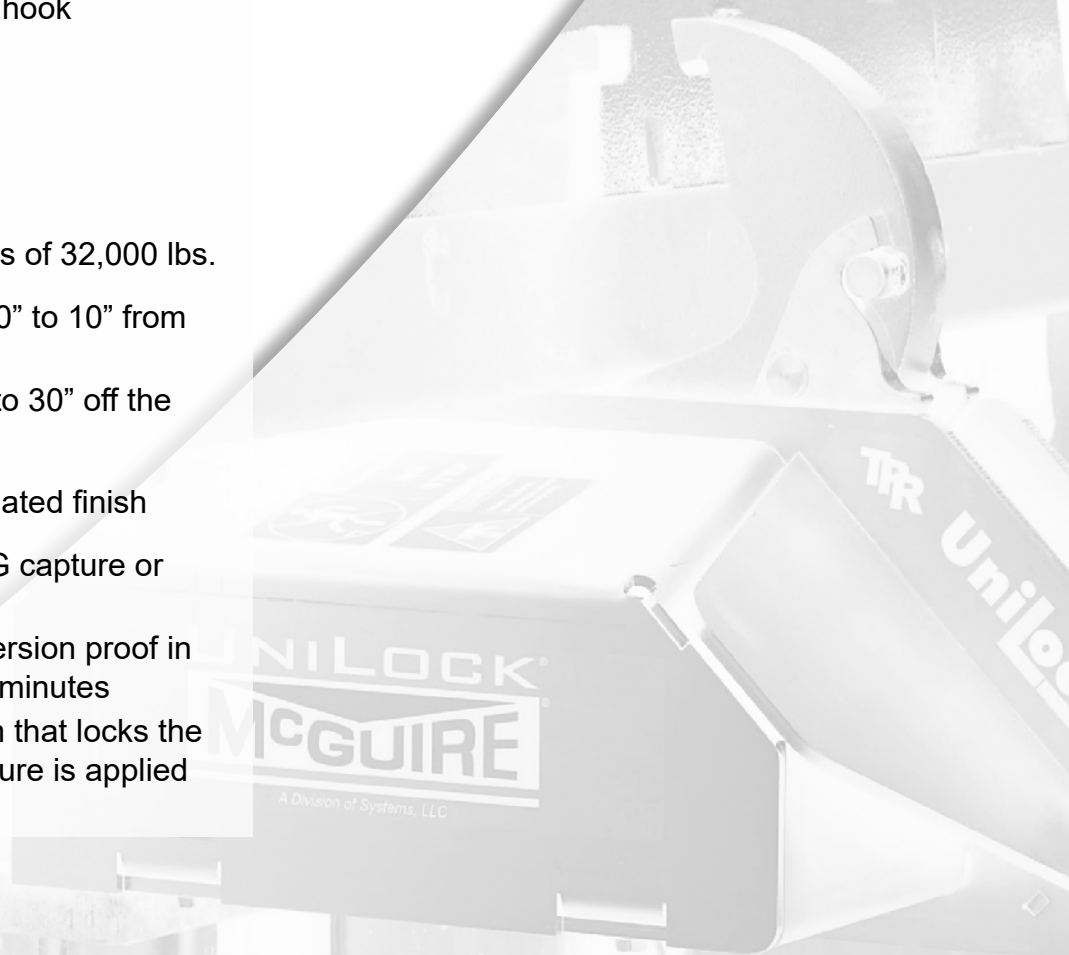

# iDock<sup>®</sup> CONTROLS

iDock helps enhance loading dock safety through superior control of dock equipment, advanced interactive communication, and providing online analytics of loading activity.



**iDock**  
CONTROLS

## ADVANCED INTERACTIVE CONTROL OF YOUR LOADING DOCK EQUIPMENT

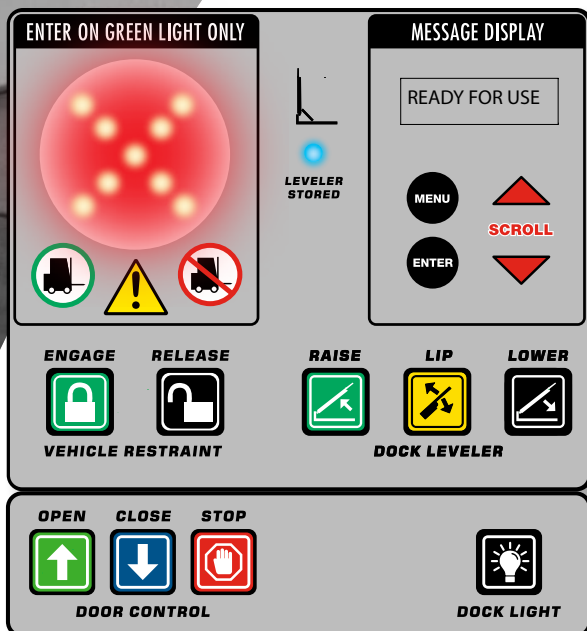

**OPERATOR INTERFACE** Using reliable membrane dome button technology, operators can clearly feel and hear when they press a button, confirming that the equipment will begin operation.

**INTERACTIVE MESSAGE DISPLAY** Obtain loading dock equipment information, view operational instructions, or enter a 3-digit passcode for bypass mode

**INTEGRATED CONTROLS** Integrate your installed Poweramp dock levelers, vehicle restraints, and other dock accessories, as well as door operators.

**INTERLOCKING EQUIPMENT** Interlocking controls provides a sequence of operation for your dock equipment, improving safety and energy efficiency.

**ADVANCED 3-COLOR LIGHT COMMUNICATION** Compared to other standard green and red systems, iDock Controls utilize an additional third amber light if a fault is detected or restraint is in bypass mode.



# myQ<sup>®</sup> DOCK MANAGEMENT

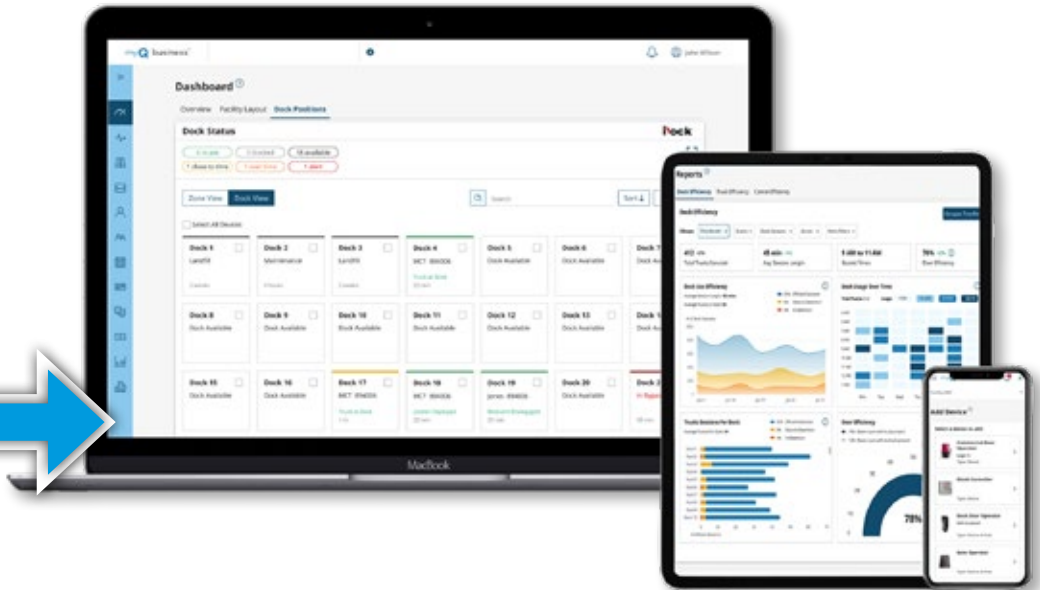

## ANALYZE YOUR LOADING DOCK ACTIVITY ONLINE

Login to your online account at **myQ.com** to review and analyze visual reports generated from your iDock controls and sensors. Enhance your loading efficiency and improve turn times.

### ONLINE REPORTS INCLUDE:

- **REAL-TIME ACTIVITY** Check the current status of each dock and time stamps of live truck-at-dock sessions.
- **LOADING DOCK ANALYTICS** Compare the efficiency and activity of any docks during a selected period of time.



**NOTIFICATIONS**  
Receive email or text message alerts of events such as restraints in bypass, after-hours activity, doors left open, and more.

### REVIEW LOADING ACTIVITY

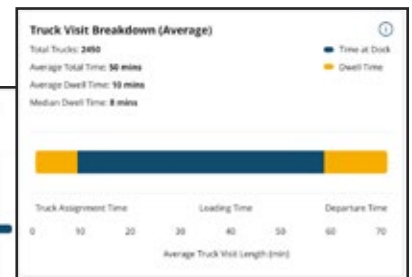
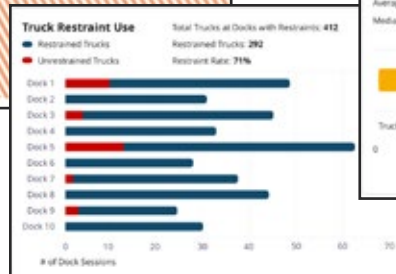
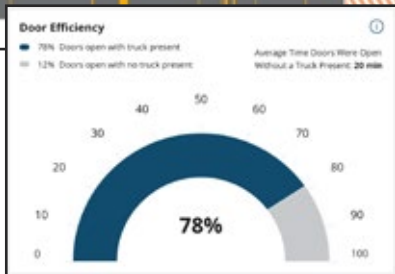

EVALUATE VEHICLE RESTRAINT/LIGHT FAULTS

MONITOR VEHICLE RESTRAINT USAGE

# SAFETY ACCESSORIES



## Safety Gate

- Pedestrian railing protection that meets or exceeds OSHA 1910.23 for elevated work platforms
- Gas strut ensures easy one-handed operation
- Designed to stay in the open position when raised

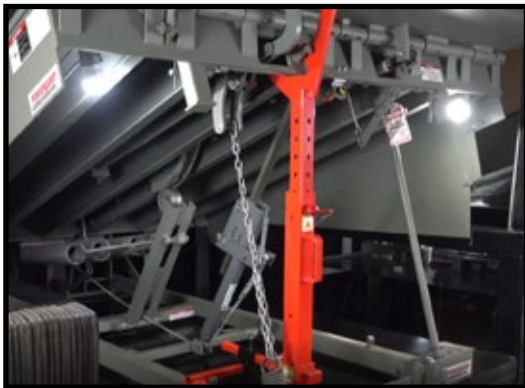

## Tough Strut

- Secondary precautionary strut for air, mechanical and select hydraulic dock levelers
- Holds dock levelers with comparative industry rating of up to 55,000 lbs.
- Structural steel construction
- Secure to the frame of the leveler

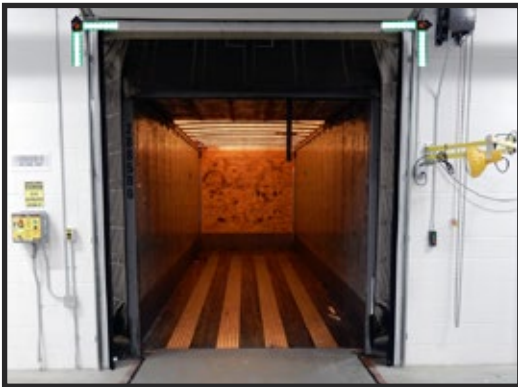

## Edge Lights

- Mimic light communication on controller
- Mount above the interior top corners of the dock door for enhanced visibility over staged product or long distances.
- Integrates with leveler and/or restraint controls
- Lights clearly indicate to dock workers when it's safe to enter the trailer

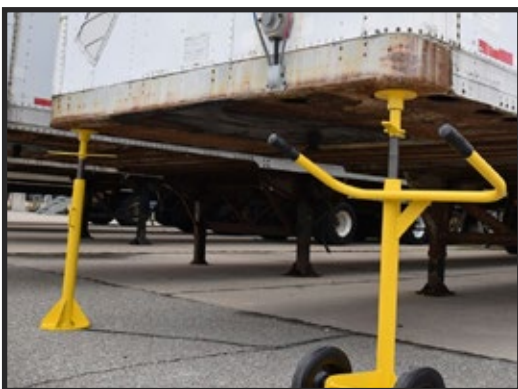

## Trailer Stabilizers and Stands

- Used to support and level the trailer while it is sitting unsupported by the tractor during loading and unloading or for storage
- 100,000 lbs. static load capacity

PROTECT YOUR EMPLOYEES AND AVOID ACCIDENTS AT THE DOCK



### **Barrier Lip**

Applied to a McGuire leveler, the Barrier Lip helps prevent forklift trucks from driving over the dock edge. While stored, the Barrier Lip extends 5"-7" above the cross traffic position, providing a full dock width solid steel barrier.

When combined with a McGuire leveler and vehicle restraint, the Barrier Lip offers the best combination in loading dock safety.

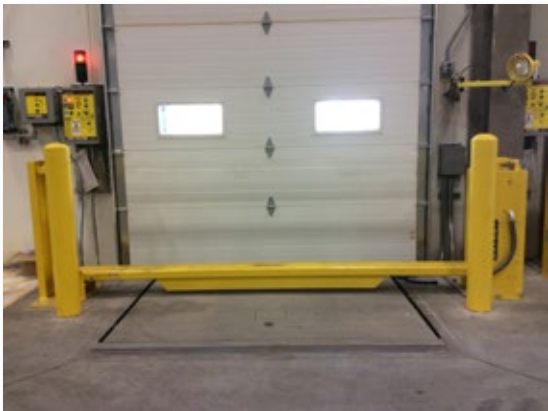

### **Bar Lift Barrier**

- Prevents forklifts from driving off the edge of the loading dock when the door is open
- Push button activation
- Rated to withstand 10,000 lbs. of force at 4 mph

**McGuire's safety barriers help prevent forklift trucks from driving over the dock edge.**





*A Division of Systems, LLC*

---

