



INDEX	PAGE(S)
MANUFACTURING TOOL STORAGE	268-269
Machining Tool Storage	270
Preconfigured Models . . .	271-273
Components	274-279
Punching Tool Storage	280
Preconfigured Models . . .	281-284
Components	283-284
Bending Tool Storage	285
Preconfigured Models . . .	286-289
Components	290-291

MANUFACTURING TOOL STORAGE SYSTEM

Manufacturing and processing steel (via machining, punching and bending) has been part of our business since 1950. Because of our vast experience in this sector, we fully understand the challenges associated with managing and storing the tools used.

These tools are a significant investment, so we have created a wide variety of storage solutions specially designed to provide maximum protection while optimizing and increasing the density of the storage.

We have leveraged our tool storage expertise to develop storage lines for punching and bending tools.

Whether you work with all these tools or specialize in just one of these areas, we are sure you will find a Rousseau storage solution that meets your needs.

MACHINING TOOLS

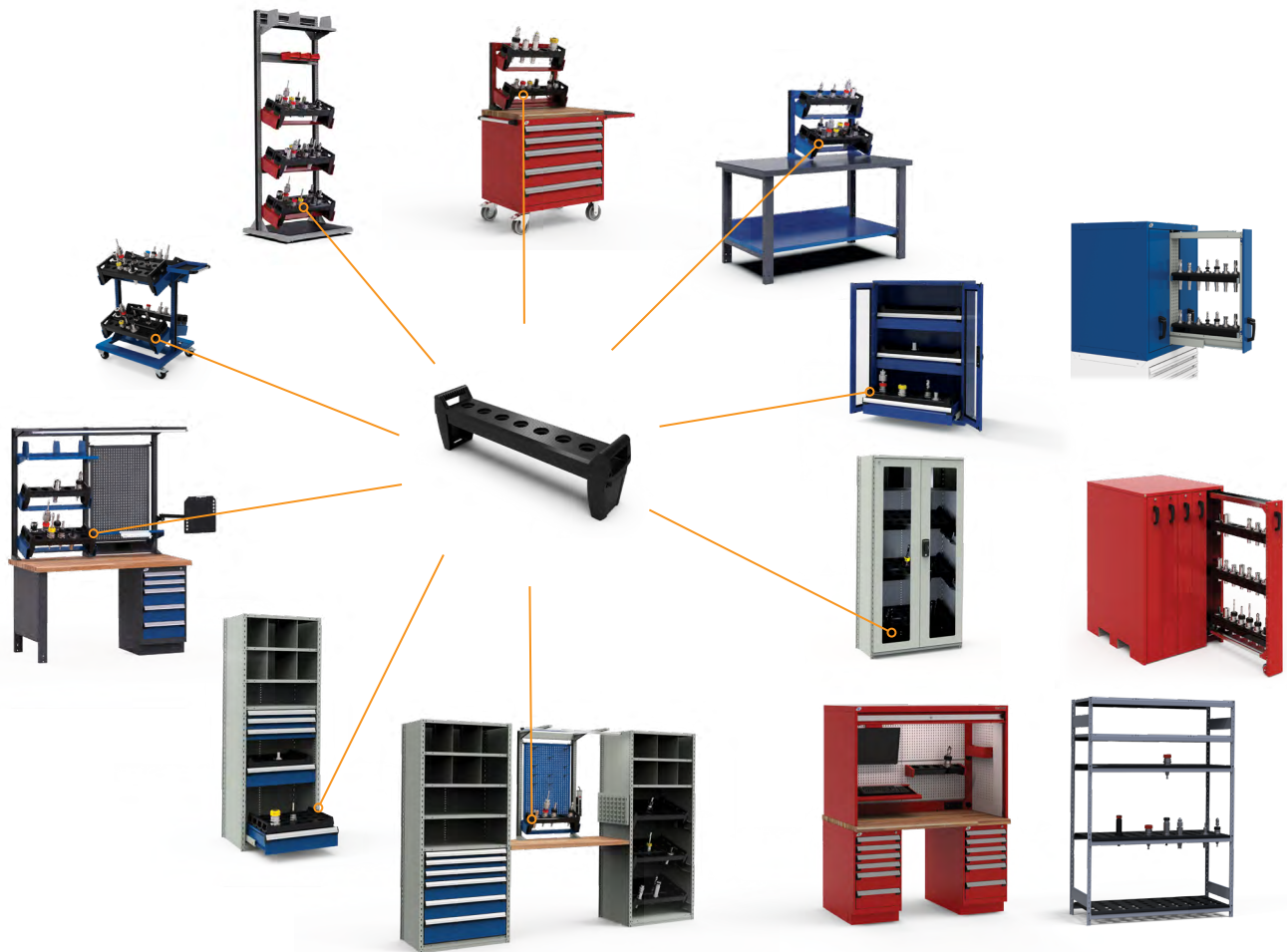

PUNCHING TOOLS



BENDING TOOLS



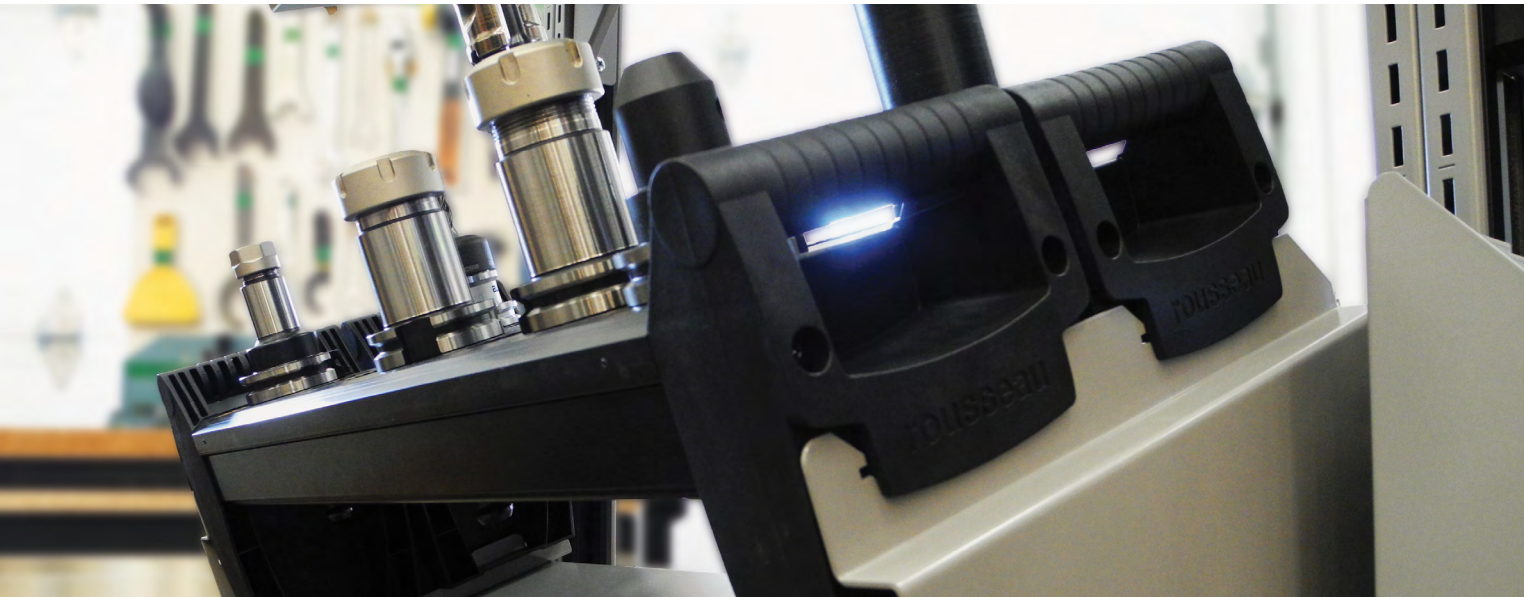

MACHINING TOOL STORAGE

With the flexibility of our Machining Tool Storage line, your tools are always protected during regular handling, transportation and storage. Rousseau's CNC tool rack is unique in many ways, it is:

- **Modular:** It is compatible with the entire Rousseau product range
- **Adaptable:** Available blank or with perforations, it can be adapted to any type of tool
- **Sturdy:** Maximum support and stability prevents tools from falling, even when the rack is tilted

- **Ergonomic:** Practical, ergonomic handles make it easy to carry. The 20° angled adapters facilitate handling of parts in Spider® Shelving and on WM uprights
- **Secure:** With its resistant PVC extruded design, it can withstand blows and corrosion, and allows fluids to drain away, which prolongs the life of your tools

The racks also feature a tool identification zone for quick and easy tool retrieval.



IMPORTANT

CNC tool storage products include blank tool racks by default. To order models with perforated racks, contact Customer Service or consult the Price Tool on e-Rousseau

87"H SHELVING WITH MODULAR DRAWERS



NCS2392

PRODUCT NO.	W×D×H	NO. OF RACKS
NCS2392	30"×24"×87"	8

- 1 drawer, 3"H with groove trays
- 1 drawer, 4"H with foam for collets
- 1 drawer, 4"H with compartments
- 2 drawers, 7"H with adapters
- 5 shelves
- 1 set of 48"H mounting brackets
- 4 shelf dividers
- 2 welded closed uprights
- 1 front base
- 4 floor anchor plates
- 1 floor anchoring hardware kit
- 2 back panels
- 8 blank NC tool racks



Shelving with drawers must be anchored to the floor (anchor kit included).

75"H SHELVING WITH ADAPTERS



NCS4195



NCS4196

PRODUCT NO.	W×D×H	NO. OF RACKS
NCS4195	36"×18"×75"	9

- 3 shelves
- 3 pairs of tool rack adapters
- 2 shelf dividers
- 2 welded closed uprights
- 1 front base
- 4 floor anchor plates
- 1 floor anchoring hardware kit
- 2 back panels
- 9 blank NC tool racks

PRODUCT NO.	W×D×H	NO. OF RACKS
NCS4196	36"×18"×75"	9

- 3 shelves
- 3 pairs of tool rack adapters
- 2 shelf dividers
- 2 welded closed uprights
- 1 front base
- 4 floor anchor plates
- 1 floor anchoring hardware kit
- 2 back panels
- 9 blank NC tool racks
- Polycarbonate doors with frame and L3 lock



Multi-level shelving is not recommended if first-level shelving only contains tool racks and two shelves.

MINI-RACKING



NCS6194

PRODUCT NO.	W×D×H
NCS6194	60"×24"×87"

- 5 pairs of heavy-duty beams
- 2 welded Mini-Racking uprights
- 5 heavy-duty tie bars
- 2 steel decking levels
- 3 blank PVC decking levels

NOTES: Load capacity per steel decking level: 1,925lb.
Load capacity per PVC decking level: 1,000lb.

IMPORTANT

This CNC tool storage product includes NC33 blank tool decking by default. To order a model with NC34 perforated decking, contact Customer Service or consult the Price Tool on e-Rousseau.

PRECONFIGURED MODELS

IMPORTANT

CNC tool storage products include blank tool racks by default. To order models with perforated racks, contact Customer Service or consult the Price Tool on e-Rousseau

MOBILE CABINET



NCM8195

PRODUCT NO.	W×D×H	NO. OF RACKS
NCM8195	36"×24"×61½"	2

- 1 cabinet with standard lock
- 1 laminated hardwood top
- 1 pair of 6" rigid casters
- 1 pair of 6" swivel casters with total-lock brake
- 1 side handle
- 5 drawers with integrated lock-in mechanism
 - 2 drawers, 4"H
 - 3 drawers, 6"H
- 1 single WM frame
- 1 foldaway shelf
- 2 standard WM tool rack adapters
- 2 blank NC tool racks

NOTE: Drawer compartments are not included and must be ordered separately, [see page 231](#).

MODULAR CABINET



NCM0097

PRODUCT NO.	W×D×H	NO. OF RACKS
NCM0097	36"×24"×60"	12

- 1 cabinet with One-Drawer-at-a-Time system
- 1 forklift base, 2"H
- 3 drawers, 7"H with adapters
- 12 blank NC tool racks

WORKSTATION WITH WM BENCH FRAME



NCW0598

PRODUCT NO.	W×D×H	NO. OF RACKS
NCW0598	60"×30"×80"	3

- 1 double WM bench frame
- 2 tiltable shelves
- 3 partial dividers
- 1 power outlet module
- 1 document holder with arm
- 1 utility panel
- 1 panel bracket kit
- 1 pack of 10 double back single hooks
- 1 overhead LED workstation light
- 1 WM tool holder
- 2 WM tool rack adapters:
 - 1 single
 - 1 double
- 1 pair of cantilever overhead supports
- 1 laminated hardwood top
- 1 closed leg, 27"D×32"H
- 1 side panel
- 1 L cabinet, 5 drawers with compartments
 - 2 drawers, 3"H
 - 3 drawers, 6"H
- 3 blank NC tool racks

IMPORTANT

CNC tool storage products include blank tool racks by default. To order models with perforated racks, contact Customer Service or consult the Price Tool on e-Rousseau

STATIONARY WM STAND



NCW0259

PRODUCT NO.	W×D×H	NO. OF RACKS
NCW0259	32" × 27" × 54"	8

- 1 WM stand with leveling glides kit
- 4 double WM tool rack adapters
- 2 plastic bin rails
- 2 tiltable shelves
- 6 partial dividers
- 8 blank NC tool racks

NOTE: Red plastic bins are not available from Rousseau.

MOBILE CART



NCW0109

PRODUCT NO.	W×D×H	NO. OF RACKS
NCW0109	32" × 27" × 41¼"	8

- 1 mobile cart with 4" casters
- 1 shelf with handle
- 4 double WM tool rack adapters
- 8 blank NC tool racks

R2V CABINET



NCLDG-380001L3A

PRODUCT NO.	W×D×H	NO. OF RACKS
NCLDG-380001L3A	30" × 27" × 38"	10

- 1 R2V cabinet with standard lock
- 2 vertical drawers (11"W)
- 1 vertical drawer (6"W)
- 10 blank NC tool racks



VTZ CABINET



NCV-GH620001L3

PRODUCT NO.	W×D×H	NO. OF RACKS
NCV-GH620001L3	37½" × 44" × 62"	15

- 1 VTZ cabinet with standard locks
- 5 vertical drawers (7"W)
- 15 blank NC tool racks



TOOL RACKS

TOOL RACK FOR WM, DRAWERS AND SHELVING



NC10 / NC12



NC12



NC10

- Perforated or blank rack available
- Made of resistant PVC, the extruded part of the rack protects tools against impacts, corrosion and metal shards
- Widths available: 30" and 36"
- Includes an identification zone for quick and easy tool retrieval
- Compatible with 28"W and 34"W WM11 frames (or two WM10 uprights and a WM15 crossmember) and WMA units with NC50 adapters
- Compatible with WM35 wall-mounted frames with NC50 adapters
- Compatible with RF31, RF32, RF33, RF34, RF35 and RF36 drawers (with NC54 adapters) in the following sizes: 30"W×21"D, 36"W×18"D, 30"W×24"D, 36"W×24"D, 30"W×27"D
- Compatible with Spider® shelving (with NC51 adapters) in the following sizes: 30"W×24"D, 36"W×18"D, 36"W×24"D
- Color: black

SHELVING - WM UPRIGHTS AND FRAMES - CABINETS

CNC tool storage products (see pages 271-273) include NC10 blank tool racks by default. To order models with NC12 perforated racks, contact Customer Service or consult the Price Tool on e-Rousseau.

The following table specifies the product number corresponding to your tool type.

TOOL RACK C/C DIMENSIONS	30"W TOOL RACK 28" C/C		36"W TOOL RACK 34" C/C	
	25 1/4"W × 5"D × 7 1/4"H		31 1/4"W × 5"D × 7 1/4"H	
	ACTUAL DIMENSIONS	25 1/4"W × 5"D × 7 1/4"H	31 1/4"W × 5"D × 7 1/4"H	31 1/4"W × 5"D × 7 1/4"H
TOOL TYPE	PRODUCT NO.	NO. OF HOLES	PRODUCT NO.	NO. OF HOLES
Blank rack	NC10-3000	–	NC10-3600	–
Taper 30	NC12-3001	10	NC12-3601	12
Taper 40	NC12-3003	7	NC12-3603	9
Taper 45	NC12-3004	6	NC12-3604	7
Taper 50	NC12-3005	5	NC12-3605	6
3/4" Straight	NC12-3010	20	NC12-3610	26
1" Straight	NC12-3011	20	NC12-3611	26
1 1/4" Straight	NC12-3013	20	NC12-3613	26
1 1/2" Straight	NC12-3015	8	NC12-3615	10
1 3/4" Straight	NC12-3016	8	NC12-3616	10
2" Straight	NC12-3018	6	NC12-3618	7
2 1/4" Straight	NC12-3019	6	NC12-3619	7
2 1/2" Straight	NC12-3021	6	NC12-3621	7
C3 Sandvik Capto	NC12-3030	22	NC12-3630	26
C4 Sandvik Capto	NC12-3031	22	NC12-3631	26
C5 Sandvik Capto	NC12-3032	10	NC12-3632	12
C6 Sandvik Capto	NC12-3033	7	NC12-3633	9
C8 Sandvik Capto	NC12-3034	6	NC12-3634	7
HSK 25 (A-C-E)	NC12-3040	22	NC12-3640	26
HSK 32 (A-C-E)	NC12-3041	22	NC12-3641	26
HSK 40 (A-C-E)	NC12-3042	22	NC12-3642	26
HSK 50 (A-C-E)	NC12-3043	10	NC12-3643	12
HSK 63 (A-C-E)	NC12-3044	7	NC12-3644	9
HSK 80 (A-C-E)	NC12-3045	5	NC12-3645	6
HSK 100 (A-C-E)	NC12-3046	4	NC12-3646	5
32 KM	NC12-3050	22	NC12-3650	26
40 KM	NC12-3051	22	NC12-3651	26
50 KM	NC12-3052	10	NC12-3652	12
63 KM	NC12-3053	7	NC12-3653	9
80 KM	NC12-3054	5	NC12-3654	6
VDI 30 mm	NC12-3060	6	NC12-3660	7
VDI 40 mm	NC12-3061	5	NC12-3661	6
VDI 50 mm	NC12-3062	4	NC12-3662	5



The rack can support a load of 150lb., but we recommend staying under 50lb. so the rack can be lifted safely

NOTE: The number of tools that a tool rack can hold varies according to tool diameter and the length of extruded surfaces. The number of holes specified in the table indicates the number of perforations per extruded surface.

TOOL RACK FOR TEKZONE HUTCH

NC14 / NC15



NC15



NC14

- Perforated or blank rack available
- Made of resistant PVC, the extruded part of the rack protects tools against impacts, corrosion and metal shards
- Widths available: 23" and 29"
- Includes an identification zone for quick and easy tool retrieval
- Attaches to TekZone Hutch rear utility panels at the desired height
- Color: black

TEKZONE HUTCH

The following table specifies the product number corresponding to your tool type.

TOOL RACK	23"W TOOL RACK		29"W TOOL RACK	
	23"W x 5"D x 4"H		29"W x 5"D x 4"H	
ACTUAL DIMENSIONS	PRODUCT NO.	NO. OF HOLES	PRODUCT NO.	NO. OF HOLES
Blank rack	NC14-2300	—	NC14-2900	—
Taper 30	NC15-2301	10	NC15-2901	12
Taper 40	NC15-2303	7	NC15-2903	9
Taper 45	NC15-2304	6	NC15-2904	7
Taper 50	NC15-2305	5	NC15-2905	6
¾" Straight	NC15-2310	20	NC15-2910	26
1" Straight	NC15-2311	20	NC15-2911	26
1¼" Straight	NC15-2313	20	NC15-2913	26
1½" Straight	NC15-2315	8	NC15-2915	10
1¾" Straight	NC15-2316	8	NC15-2916	10
2" Straight	NC15-2318	6	NC15-2918	7
2¼" Straight	NC15-2319	6	NC15-2919	7
2½" Straight	NC15-2321	6	NC15-2921	7
C3 Sandvik Capto	NC15-2330	22	NC15-2930	26
C4 Sandvik Capto	NC15-2331	22	NC15-2931	26
C5 Sandvik Capto	NC15-2332	10	NC15-2932	12
C6 Sandvik Capto	NC15-2333	7	NC15-2933	9
C8 Sandvik Capto	NC15-2334	6	NC15-2934	7
HSK 25 (A-C-E)	NC15-2340	22	NC15-2940	26
HSK 32 (A-C-E)	NC15-2341	22	NC15-2941	26
HSK 40 (A-C-E)	NC15-2342	22	NC15-2942	26
HSK 50 (A-C-E)	NC15-2343	10	NC15-2943	12
HSK 63 (A-C-E)	NC15-2344	7	NC15-2944	9
HSK 80 (A-C-E)	NC15-2345	5	NC15-2945	6
HSK 100 (A-C-E)	NC15-2346	4	NC15-2946	5
32 KM	NC15-2350	22	NC15-2950	26
40 KM	NC15-2351	22	NC15-2951	26
50 KM	NC15-2352	10	NC15-2952	12
63 KM	NC15-2353	7	NC15-2953	9
80 KM	NC15-2354	5	NC15-2954	6
VDI 30 mm	NC15-2360	6	NC15-2960	7
VDI 40 mm	NC15-2361	5	NC15-2961	6
VDI 50 mm	NC15-2362	4	NC15-2962	5

NOTE: The number of tools that a tool rack can hold varies according to tool diameter and the length of extruded surfaces. The number of holes specified in the table indicates the number of perforations per extruded surface.

TOOL RACKS FOR R2V CABINETS

NC73 / NC74

- Perforated or blank rack available
- Made of resistant PVC, the extruded part of the rack protects tools against impacts, corrosion and metal shards
- Depths available: 24" and 27"
- Includes an identification zone for quick and easy tool retrieval
- Capacity: 50lb
- Color: black

TOOL RACKS FOR VTZ CABINETS



NC64

- Perforated or blank rack available
- Made of resistant PVC, the extruded part of the rack protects tools against impacts, corrosion and metal shards
- Depth available: 44"
- Includes an identification zone for quick and easy tool retrieval
- Capacity: 250lb
- Color: black

DIMENSIONS	R2V CABINET				VTZ CABINET	
	24"D TOOL RACK		27"D TOOL RACK		44"D TOOL RACK	
	5"W x 19"D x 2½"H		5"W x 22"D x 2½"H		5½"W x 30"D x 3½"H	
TOOL TYPE	PRODUCT NO.	NO. OF HOLES	PRODUCT NO.	NO. OF HOLES	PRODUCT NO.	NO. OF HOLES
Blank rack	NC73-2400	—	NC73-2700	—	NC64-0704400	—
Taper 30	NC74-2401	8	NC74-2701	10	NC64-0704401	15
Taper 40	NC74-2403	6	NC74-2703	7	NC64-0704403	11
Taper 45	NC74-2404	5	NC74-2704	6	NC64-0704404	9
Taper 50	NC74-2405	4	NC74-2705	5	NC64-0704405	7
¾" Straight	NC74-2410	18	NC74-2710	20	NC64-0704410	32
1" Straight	NC74-2411	18	NC74-2711	20	NC64-0704411	32
1½" Straight	NC74-2413	18	NC74-2713	20	NC64-0704413	32
1¾" Straight	NC74-2415	7	NC74-2715	8	NC64-0704415	13
2" Straight	NC74-2416	7	NC74-2716	8	NC64-0704416	13
2½" Straight	NC74-2418	5	NC74-2718	6	NC64-0704418	9
2¾" Straight	NC74-2419	5	NC74-2719	6	NC64-0704419	9
3" Straight	NC74-2421	5	NC74-2721	6	NC64-0704421	9
C3 Sandvik Capto	NC74-2430	18	NC74-2730	20	NC64-0704430	32
C4 Sandvik Capto	NC74-2431	18	NC74-2731	20	NC64-0704431	32
C5 Sandvik Capto	NC74-2432	8	NC74-2732	10	NC64-0704432	15
C6 Sandvik Capto	NC74-2433	6	NC74-2733	7	NC64-0704433	11
C8 Sandvik Capto	NC74-2434	5	NC74-2734	6	NC64-0704434	9
HSK 25 (A-C-E)	NC74-2440	18	NC74-2740	20	NC64-0704440	32
HSK 32 (A-C-E)	NC74-2441	18	NC74-2741	20	NC64-0704441	32
HSK 40 (A-C-E)	NC74-2442	18	NC74-2742	20	NC64-0704442	32
HSK 50 (A-C-E)	NC74-2443	8	NC74-2743	10	NC64-0704443	15
HSK 63 (A-C-E)	NC74-2444	6	NC74-2744	7	NC64-0704444	11
HSK 80 (A-C-E)	NC74-2445	4	NC74-2745	5	NC64-0704445	7
HSK 100 (A-C-E)	NC74-2446	3	NC74-2746	4	NC64-0704446	6
32 KM	NC74-2450	18	NC74-2750	20	NC64-0704450	32
40 KM	NC74-2451	18	NC74-2751	20	NC64-0704451	32
50 KM	NC74-2452	8	NC74-2752	9	NC64-0704452	15
63 KM	NC74-2453	6	NC74-2753	7	NC64-0704453	11
80 KM	NC74-2454	4	NC74-2754	5	NC64-0704454	7
VDI 30 mm	NC74-2460	5	NC74-2760	6	NC64-0704460	9
VDI 40 mm	NC74-2461	4	NC74-2761	5	NC64-0704461	8
VDI 50 mm	NC74-2462	3	NC74-2762	4	NC64-0704462	6



NC73



NC64



IMPORTANT
Refer to technical guide N50 for recommended layouts based on tool height and intended use.

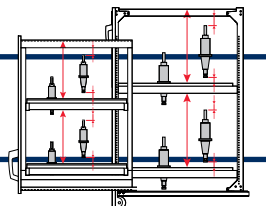

TOOL RACK ADAPTERS

WM ADAPTER

NC50



- Adapters for installing NC10 and NC12 tool racks in WM11 frames with uprights spaced 28" and 34" apart c/c (or two WM10 uprights and one WM15 crossmember) or in WMA stands, [see pages 163 and 211](#);
- For installing NC10 and NC12 tool racks in WM35 wall-mounted multi-purpose frames, [see page 213](#);
- Side security notches in the WM adapter ensure tool rack stability
- Angled forward 20° for easy access to tools
- Single and double models in two widths available for one or two racks respectively, 30" (for 28" c/c widths) and 36" (for 34" c/c widths)
- Easy assembly, no tools required

PRODUCT NO.	TYPE	WIDTH	CAPACITY
NC50-2801	Single	28" c/c	150lb
NC50-2802	Double	28" c/c	300lb
NC50-3401	Single	34" c/c	150lb
NC50-3402	Double	34" c/c	300lb

TOOL RACK DRAWERS ADAPTERS

NC54

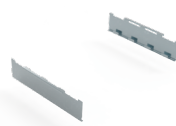

- Sold in pairs
- Adapters for installing NC10 and NC12 tool racks in 7"H heavy-duty drawers (RF31 / RF32 / RF35 / RF36) or in 10"H, 12"H or 14"H drawers for CNC tools (RF33 / RF34), [see page 220](#)
- Compatible with modular drawers of the following sizes: 30"W x 21"D, 30"W x 24"D, 30"W x 27"D, 36"W x 18"D and 36"W x 24"D
- The adapters prevent the tool racks from tipping when door is opened or closed
- Supports three or four NC10 or NC12 tool racks
- Galvanized steel
- Easy assembly, no tools required

PRODUCT NO.	DEPTH	NO. OF RACKS	CAPACITY
NC54-1801	18"	3	400lb
NC54-2101	21"	3	
NC54-2401	24"	4	
NC54-2701	27"	4	

TOOL RACK SHELVING ADAPTERS

NC51

- Sold in pairs
- Adapters for installing NC10 and NC12 tool racks in 30"W x 24"D, 36"W x 18"D and 36"W x 24"D Spider® Shelving, [see page 88](#)
- Angled forward 20° for easy access to tools
- Supports three or four NC10 or NC12 tool racks
- Compatible with Spider® shelving only
- Galvanized steel
- Easy assembly, no tools required

PRODUCT NO.	DEPTH	NO. OF RACKS	CAPACITY
NC51-1801	18"	3	450lb
NC51-2401	24"	4	600lb

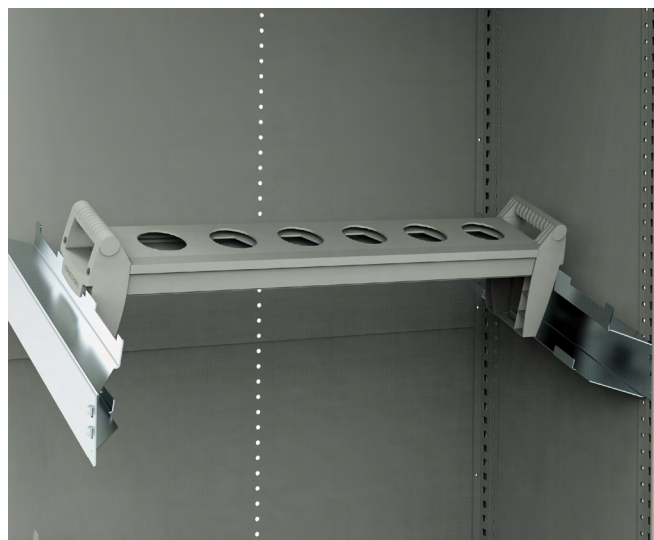
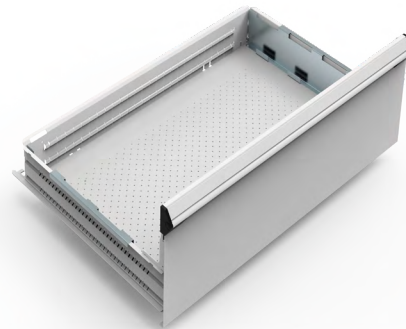

HEAVY-DUTY DRAWER FOR CNC TOOLS

RF33 / RF34



- Heavy-duty drawer for cabinets: RF33
- Heavy-duty drawer for shelving: RF34
- Closed front and open sides for easy insertion and removal of NC10 and NC12 tool racks
- Heights available: 10", 12" and 14"
- To order: Add the drawer height required to the product number, e.g., RF33-302714.

PRODUCT NO.	W x D	APPLICATION
RF33-3021__	30" x 21"	cabinet
RF33-3027__	30" x 27"	cabinet
RF33-3618__	36" x 18"	cabinet
RF33-3624__	36" x 24"	cabinet
RF34-3024__	30" x 24"	shelving*
RF34-3618__	36" x 18"	shelving*
RF34-3624__	36" x 24"	shelving*

NOTES: *Mounting brackets are required to install drawers in shelving, [see page 135](#).
NC54 Adapters must be ordered separately.



NCS6024

PVC deck sections for Mini-Racking must be ordered separately from preconfigured models. The following table specifies the product number corresponding to your tool type.

Made of resistant PVC, the extruded part of the deck section protects tools against impacts, corrosion and metal shards.

The number of tools a PVC deck can hold varies according to tool diameter and the extruded surface length. The number of holes specified in the table indicates the number of perforations per extruded surface.

- Deck section with blank (NC30) or perforated (NC31) surfaces available
- 6"W sections
- Load capacity for an 18"D PVC deck Section: 75lb.
- Load capacity for a 24"D PVC deck Section: 100lb.
- PVC deck sections can be combined with SR40 steel decking on the same level
- 6"W deck Section do not include label holders

IMPORTANT

Refer to technical guide N50 for recommended layouts based on tool height and intended use.

6"W DECK SECTIONS

TOOL TYPE	TOOL CODE	18"D PVC DECK SECTION		24"D PVC DECK SECTION	
		PRODUCT NO.	NO. OF HOLES	PRODUCT NO.	NO. OF HOLES
Blank rack	00	NC30-1800	—	NC30-2400	—
Taper 30	01	NC31-1801	8	NC31-2401	10
Taper 40	03	NC31-1803	7	NC31-2403	9
Taper 45	04	NC31-1804	4	NC31-2404	5
Taper 50	05	NC31-1805	4	NC31-2405	5
¾" Straight	10	NC31-1810	14	NC31-2410	18
1" Straight	11	NC31-1811	14	NC31-2411	18
1¼" Straight	13	NC31-1813	14	NC31-2413	18
1½" Straight	15	NC31-1815	5	NC31-2415	7
1¾" Straight	16	NC31-1816	5	NC31-2416	7
2" Straight	18	NC31-1818	4	NC31-2418	5
2¼" Straight	19	NC31-1819	4	NC31-2419	5
2½" Straight	21	NC31-1821	4	NC31-2421	5
C3 Sandvik Capto	30	NC31-1830	18	NC31-2430	24
C4 Sandvik Capto	31	NC31-1831	18	NC31-2431	24
C5 Sandvik Capto	32	NC31-1832	7	NC31-2432	9
C6 Sandvik Capto	33	NC31-1833	7	NC31-2433	9
C8 Sandvik Capto	34	NC31-1834	4	NC31-2434	5
HSK 25 (A-C-E)	40	NC31-1840	18	NC31-2440	24
HSK 32 (A-C-E)	41	NC31-1841	18	NC31-2441	24
HSK 40 (A-C-E)	42	NC31-1842	18	NC31-2442	24
HSK 50 (A-C-E)	43	NC31-1843	8	NC31-2443	10
HSK 63 (A-C-E)	44	NC31-1844	5	NC31-2444	7
HSK 80 (A-C-E)	45	NC31-1845	4	NC31-2445	5
HSK 100 (A-C-E)	46	NC31-1846	3	NC31-2446	4
32 KM	50	NC31-1850	18	NC31-2450	24
40 KM	51	NC31-1851	18	NC31-2451	24
50 KM	52	NC31-1852	8	NC31-2452	10
63 KM	53	NC31-1853	5	NC31-2453	7
80 KM	54	NC31-1854	4	NC31-2454	5
VDI 30 mm	60	NC31-1860	7	NC31-2460	9
VDI 40 mm	61	NC31-1861	4	NC31-2461	5
VDI 50 mm	62	NC31-1862	3	NC31-2462	4

PVC DECKING FOR CNC TOOLS

NC33 / NC34

PVC decking for Mini-Racking must be ordered separately from preconfigured models. Made of resistant PVC, the extruded part of the decking protects tools against impacts, corrosion and metal shards.

To find out the number of tools you can store in perforated decking, multiply the number of perforated deck sections in your decking by the number of holes in an NC31 deck section, see page 278.

- Decking with perforated (NC33) or blank (NC34) surfaces available
- Models for 48"W, 60"W and 72"W Mini-Racking levels available. Perforated model numbers must be completed with the tool code
- Load capacity for an 18"D PVC deck section: 75lb.
- Load capacity for a 24"D PVC deck section: 100lb.
- PVC decking can be combined with SR40 steel decking on the same level
- The decking includes an NC32 label holder
- To order NC34 decking, complete the product number with the tool code, see page 278, e.g., NC34-602405 for 60"W×24"D decking for Taper 50 tools

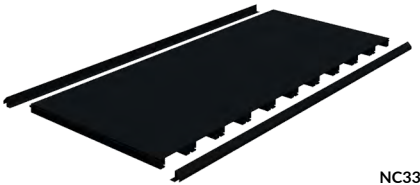

NC33



NC34

DECKING COMPOSED OF INDIVIDUAL 6"W DECK SECTIONS

BEAM WIDTH	DECK SECTION DEPTH	BLANK SURFACE (NC30 DECK SECTION)	PERFORATED SURFACE (NC31 SDECK SECTION)	NO. OF DECK SECTIONS
48"	18"	NC33-481800	NC34-4818_ _	8
	24"	NC33-482400	NC34-4824_ _	
60"	18"	NC33-601800	NC34-6018_ _	10
	24"	NC33-602400	NC34-6024_ _	
72"	18"	NC33-721800	NC34-7218_ _	12
	24"	NC33-722400	NC34-7224_ _	



PUNCHING TOOL STORAGE SOLUTIONS



PUNCHING TOOL STORAGE

Rousseau's storage system for punching tools has been specially designed to provide efficient and organized storage for type A, B, C, D and E (thick turret) tools.

Whether you need to store your tools close to your machines, transport them for maintaining them (sharpening and lubrication),

inspect them before using them, or perform quality control on manufactured parts, we have a solution for you.

To optimize and increase the density of your tool storage, we recommend three solutions depending on the type of punch and die you use.

STORAGE TYPE	TOOL POSITION	TOOLS ASSEMBLED	
Storage trays	Tools lie flat	Assembled or non-assembled	
Partitions and dividers	Tools upright	Non-assembled	
Punching tool racks	Dies lie flat or upright and punches are upright ¹	Non-assembled but grouped together	

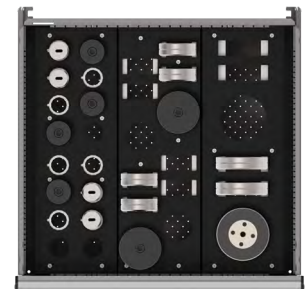
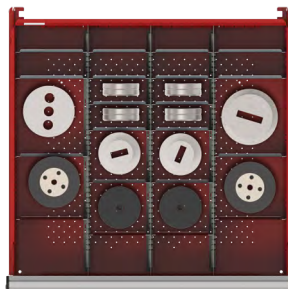

NOTE: ¹ See page 284, for more details.



The drawer interior layouts included in the preconfigured cabinet models are labeled 1 to 8 and can be found on [pages 283-284](#).

32" HIGH (W x D x H)

Width
30" 36"



5 DRAWERS		Width	
N5PADG-3001L3	30" x 27" x 32"	30"	1 2 4
N5PAEG-3001L3	36" x 27" x 32"	36"	5 6 8



4 DRAWERS		Width	
N5PADG-3002L3	30" x 27" x 32"	30"	1 3 4
N5PAEG-3002L3	36" x 27" x 32"	36"	5 7 8



4 DRAWERS		Width	
N5PADG-3003L3	30" x 27" x 32"	30"	2 4
N5PAEG-3003L3	36" x 27" x 32"	36"	4 8

40" HIGH (W x D x H)



8 DRAWERS		Width	
N5PADG-3801L3	30" x 27" x 40"	30"	1 3 4
N5PAEG-3801L3	36" x 27" x 40"	36"	5 7 8



7 DRAWERS		Width	
N5PADG-3802L3	30" x 27" x 40"	30"	1 3 4
N5PAEG-3802L3	36" x 27" x 40"	36"	5 7 8



5 DRAWERS		Width	
N5PADG-3803L3	30" x 27" x 40"	30"	1 3 4
N5PAEG-3803L3	36" x 27" x 40"	36"	5 7 8

60" HIGH (W x D x H)



11 DRAWERS		Width	
N5PADG-5801L3	30" x 27" x 60"	30"	1 3 4
N5PAEG-5801L3	36" x 27" x 60"	36"	5 7 8

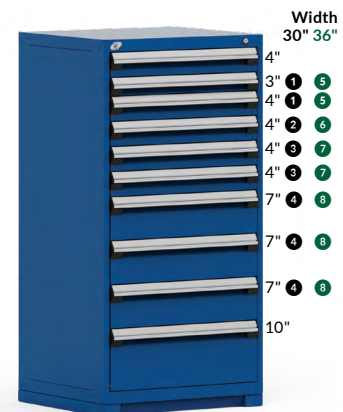

10 DRAWERS		Width	
N5PADG-5802L3	30" x 27" x 60"	30"	1 2 3 4
N5PAEG-5802L3	36" x 27" x 60"	36"	5 6 7 8



10 DRAWERS		Width	
N5PADG-5803L3	30" x 27" x 60"	30"	1 3 4
N5PAEG-5803L3	36" x 27" x 60"	36"	5 7 8

PRECONFIGURED MODELS



The drawer interior layouts included in the preconfigured cabinet models are labeled 1 to 8 and can be found on [pages 283-284](#).

37 1/2" HIGH (W x D x H)



5 DRAWERS

N5PBDG-3001L3A	30" x 27" x 37 1/2"	1 3 4
N5PBEG-3001L3A	36" x 27" x 37 1/2"	5 7 8



4 DRAWERS

N5PBDG-3002L3A	30" x 27" x 37 1/2"	1 3 4
N5PBEG-3002L3A	36" x 27" x 37 1/2"	5 7 8



4 DRAWERS

N5PBDG-3003L3A	30" x 27" x 37 1/2"	2 4
N5PBEG-3003L3A	36" x 27" x 37 1/2"	6 8

41 1/2" HIGH (W x D x H)



6 DRAWERS

N5PBDG-3401L3A	30" x 27" x 41 1/2"	1 2 3 4
N5PBEG-3401L3A	36" x 27" x 41 1/2"	5 6 7 8



6 DRAWERS

N5PBDG-3402L3A	30" x 27" x 41 1/2"	1 3 4
N5PBEG-3402L3A	36" x 27" x 41 1/2"	5 7 8



5 DRAWERS

N5PBDG-3403L3A	30" x 27" x 41 1/2"	1 3
N5PBEG-3403L3A	36" x 27" x 41 1/2"	5 7

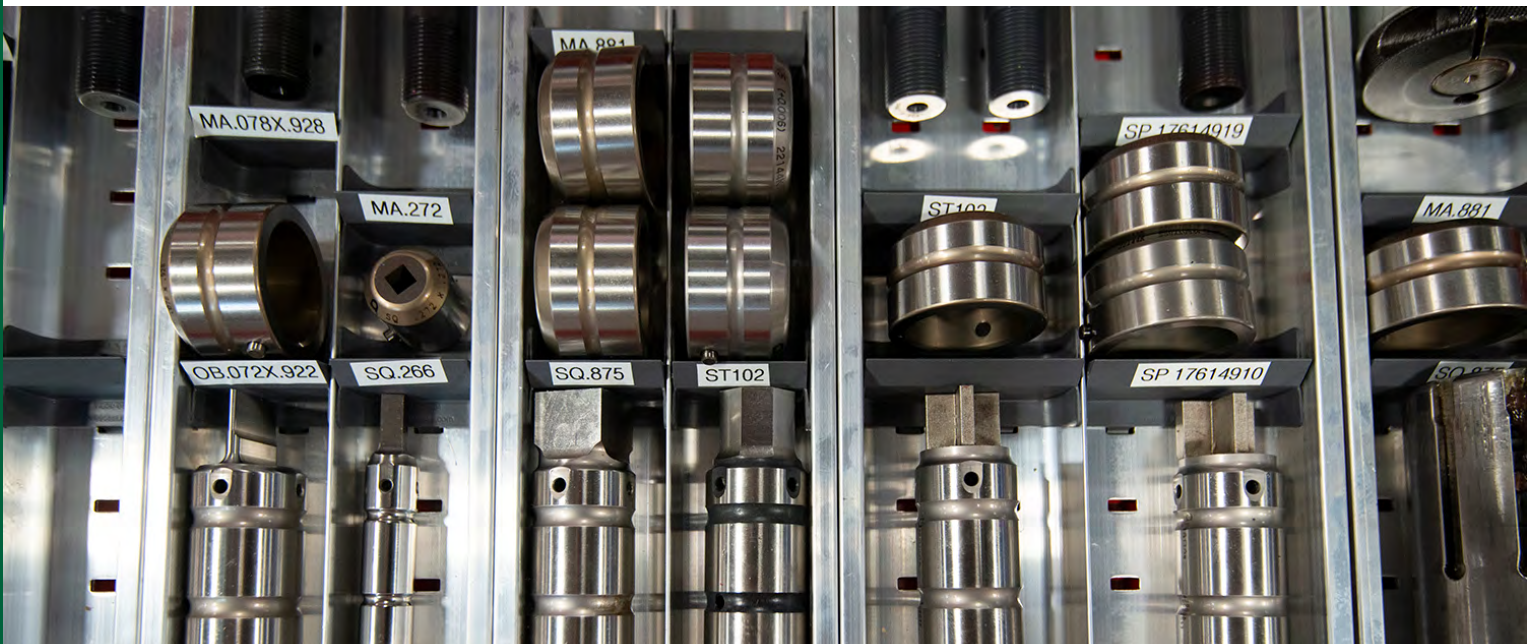



The drawer interior layouts included in the preconfigured cabinet models on pages 281-282 are labeled 1 to 8.

You can choose other drawer interiors, including tool racks, see pages 283-284.

MODEL ORDERS MUST BE COMPLETED AS FOLLOWS :

00 for subdividing only
51 for a subdivided drawer

Drawer height
in inches

e.g., R __ EG-A042604

Locking mechanism :

L3: Lock on the drawer

A: Integrated Lock-In Mechanism (prevents the drawer from opening on its own when cabinet is moved)

L3A: Lock on the drawer and Integrated Lock-In Mechanism (prevents the drawer from opening on its own when cabinet is moved)

e.g., R51EG-TW1604A
For a 36"W x 27"D subdivided drawer and Integrated Lock-In Mechanism.

IMPORTANT

1.64"W storage trays can only store type A tools.

2.64"W storage trays can store type A and type B tools.

IMPORTANT

Models with partitions and dividers are designed to store disassembled tools. We do not recommend storing assembled tools in them.

IMPORTANT

The quantities shown in the models with storage trays or with partitions and dividers are for illustrative purposes only. The number of punches and dies stored will vary based on the client's specific situation.

30"W x 27"D DRAWERS

PUNCH AND DIE RACKS



N00DG-P0100
N51DG-P0110__
N51DG-P0111__

Tools	Punch	Dies
B	4	12
C	4	8
D	2	4



N00DG-P0200
N51DG-P0210__
N51DG-P0211__

Tools	Punch	Dies
C	12	24



N00DG-P0300
N51DG-P0310__
N51DG-P0311__

Tools	Punch	Dies
C	4	8
D	2	4
E	2	4

RACKS AND DIVIDERS

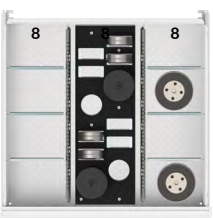

N00DG-P0400
N51DG-P0410__
N51DG-P0411__

Tools	Punch	Dies
C	4	8
C D E	8	

STORAGE TRAYS

1

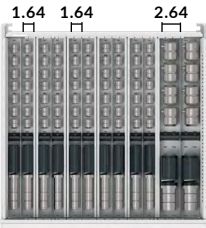

R __ DG-TW1203 __
R __ DG-TW1204 __

Tools	Punch	Dies
A	12	60

2

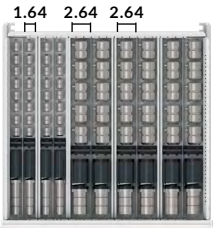

R __ DG-TW1004 __

Tools	Punch	Dies
A	4	20
B	6	18

3



R __ DG-TW0804 __

Tools	Punch	Dies
B	8	24

PARTITIONS AND DIVIDERS

4

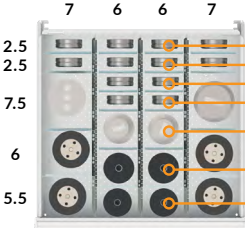

N __ DG-A032007 __

Tools	Punch	Dies
C D E	12	12

PRECONFIGURED MODELS / COMPONENTS



36"W x 27"D DRAWERS

PUNCH AND DIE RACKS

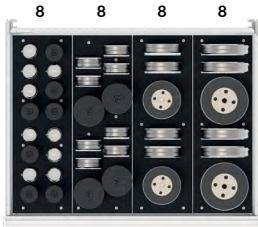

N00EG-P0100		
N51EG-P0110__		
N51EG-P0111__		
Tools	Punch	Dies
B	4	12
C	4	8
D	2	4
E	2	4

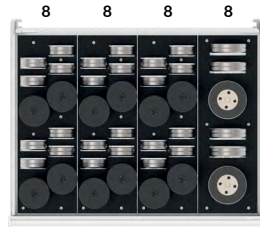

N00EG-P0200		
N51EG-P0210__		
N51EG-P0211__		
Tools	Punch	Dies
C	12	24
D	2	4



N00EG-P0300		
N51EG-P0310__		
N51EG-P0311__		
Tools	Punch	Dies
C	8	16
D	2	4
E	2	4

RACKS AND DIVIDERS

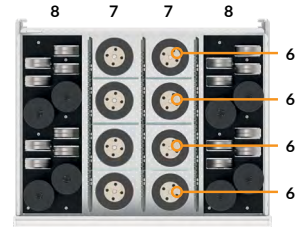

N00EG-P0400		
N51EG-P0410__		
N51EG-P0411__		
Tools	Punch	Dies
C	8	16
C D E	8	

STORAGE TRAYS

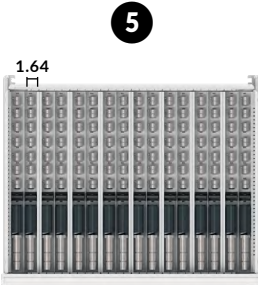

R__EG-TW1603__		
R__EG-TW1604__		
Tools	Punch	Dies
A	16	80

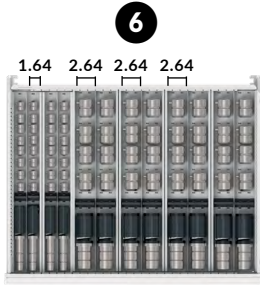

R__EG-TW1204__		
Tools	Punch	Dies
A	4	20
B	8	24

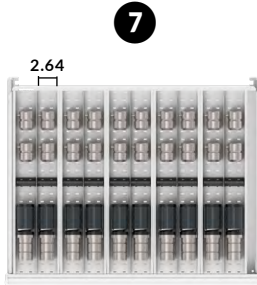

R__EG-TW1004__		
Tools	Punch	Dies
B	10	30

PARTITIONS AND DIVIDERS

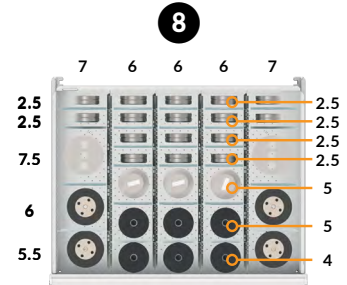

N__EG-A042607__		
Tools	Punch	Dies
C D E	14	16

PUNCHING TOOL RACKS

These tools racks are made of galvanized steel and protected with a 1/4" thick durable PVC plate. Punches are supported by their shoulders and do not rest directly on the drawer bottom. The racks spread the load and prevent buckling of the drawer bottom.

- Trays A and B store 3 dies (lying flat) for every punch
- Trays C, D and E store 2 dies (upright) for every punch
- Versions C, D and E include a second level to stabilize the position of the tools
- Recommended for maximum 36"W housings
- Designed to be installed in a 10"H or 11"H (9" usable height) drawer, 27" deep.
- Width: 8"



NC83-082701		
8" x 27" x 9"		
Tools	Punch	Dies
A	12	36



NC83-082702		
8" x 27" x 9"		
Tools	Punch	Dies
B	4	12



NC83-082703		
8" x 27" x 9"		
Tools	Punch	Dies
C	4	8



NC83-082704		
8" x 27" x 9"		
Tools	Punch	Dies
D	2	4



NC83-082705		
8" x 27" x 9"		
Tools	Punch	Dies
E	2	4



BENDING TOOL STORAGE SYSTEM

Rousseau's bending tool storage system has been designed to provide maximum protection for your punches and dies while offering optimal and ergonomic storage.

Our storage solutions have been engineered for the tools you use, and they take into account the management methods available for storing and transporting them within your company. Our range of solutions are compatible with multiple tool styles: American, European, Wilson WT, Wila NS, Trumpf and more.

Whether you use a system where the tools are stored in a central store then allocated based on the daily production schedule, or each press brake has a toolbox containing the punches and dies needed for specific tasks, we are sure you will find a Rousseau storage solution that meets your needs.

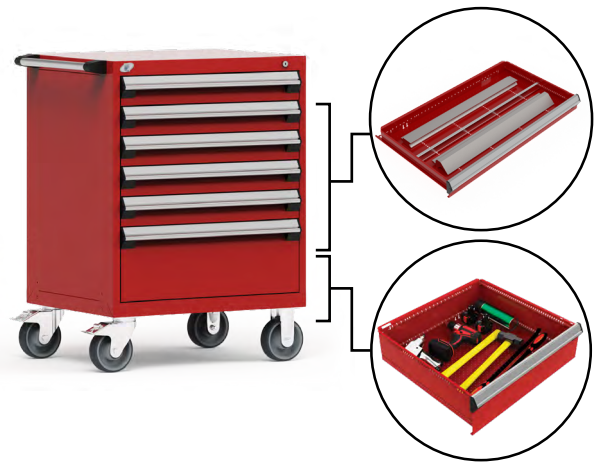
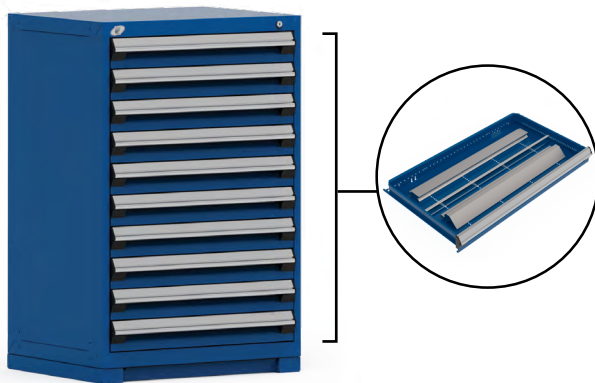



STATIONARY CABINETS

The tools used for bending sheet metal are heavy and come in many different shapes. To store them regardless of their shape, size or weight, we offer a reinforced RF62 tool drawer fitted with a RG07

structural partition. Extra structural partitions can be added as needed to increase the number of subdivisions inside the drawer. [See page 291.](#)



W x D		DRAWER HEIGHT AND LAYOUT																							
		36"								40"															
		RF62		RF31		RF62		RF31		RF62		RF31		RF62		RF31									
		H	QTY	H	QTY	H	QTY	H	QTY	H	QTY	H	QTY	H	QTY	H	QTY								
30" x 24"		4"	5	5"	2	-	-	4"	5	-	-	10"	1	4"	6	5"	2	-	-	4"	6	-	-	10"	1
		N5BADE-3401L3				N5BADE-3402L3				N5BADE-3801L3				N5BADE-3802L3											
		N5BADG-3401L3				N5BADG-3402L3				N5BADG-3801L3				N5BADG-3802L3											
		N5BAEE-3401L3				N5BAEE-3402L3				N5BAEE-3801L3				N5BAEE-3802L3											
		N5BAEG-3401L3				N5BAEG-3402L3				N5BAEG-3801L3				N5BAEG-3802L3											
		N5BAGE-3401L3				N5BAGE-3402L3				N5BAGE-3801L3				N5BAGE-3802L3											
		N5BAGG-3401L3				N5BAGG-3402L3				N5BAGG-3801L3				N5BAGG-3802L3											
		N5BAHE-3401L3				N5BAHE-3402L3				N5BAHE-3801L3				N5BAHE-3802L3											
		N5BAHG-3401L3				N5BAHG-3402L3				N5BAHG-3801L3				N5BAHG-3802L3											
		N5BAJE-3401L3				N5BAJE-3402L3				N5BAJE-3801L3				N5BAJE-3802L3											
		N5BAJG-3401L3				N5BAJG-3402L3				N5BAJG-3801L3				N5BAJG-3802L3											



W x D		DRAWER HEIGHT AND LAYOUT																					
		46"								60"													
		RF62		RF31		RF62		RF31		RF62		RF31		RF62		RF31							
		H	QTY	H	QTY	H	QTY	H	QTY	H	QTY	H	QTY	H	QTY	H	QTY						
30" x 24"		4"	10	-	-	4"	8	-	-	8"	1	4"	11	5"	2	-	-	4"	11	-	-	10"	1
		N5BADE-4401L3				N5BADE-4402L3				N5BADE-5801L3				N5BADE-5802L3									
		N5BADG-4401L3				N5BADG-4402L3				N5BADG-5801L3				N5BADG-5802L3									
		N5BAEE-4401L3				N5BAEE-4402L3				N5BAEE-5801L3				N5BAEE-5802L3									
		N5BAEG-4401L3				N5BAEG-4402L3				N5BAEG-5801L3				N5BAEG-5802L3									
		N5BAGE-4401L3				N5BAGE-4402L3				N5BAGE-5801L3				N5BAGE-5802L3									
		N5BAGG-4401L3				N5BAGG-4402L3				N5BAGG-5801L3				N5BAGG-5802L3									
		N5BAHE-4401L3				N5BAHE-4402L3				N5BAHE-5801L3				N5BAHE-5802L3									
		N5BAHG-4401L3				N5BAHG-4402L3				N5BAHG-5801L3				N5BAHG-5802L3									
		N5BAJE-4401L3				N5BAJE-4402L3				N5BAJE-5801L3				N5BAJE-5802L3									
		N5BAJG-4401L3				N5BAJG-4402L3				N5BAJG-5801L3				N5BAJG-5802L3									



MOBILE CABINETS



W x D	DRAWER HEIGHT AND LAYOUT																							
	37½"												41½"											
	RF62				RF31				RF62				RF31				RF62				RF31			
	H	QTY	H	QTY	H	QTY	H	QTY	H	QTY	H	QTY	H	QTY	H	QTY	H	QTY	H	QTY				
30" x 24"	4"	4	5"	2	-	-	4"	4	-	-	10"	1	4"	5	5"	2	-	-	4"	5	5"	2	10"	1
	N5BBDE-3001L3A				N5BBDE-3002L3A				N5BBDE-3401L3A				N5BBDE-3402L3A											
30" x 27"	N5BBDG-3001L3A				N5BBDG-3002L3A				N5BBDG-3401L3A				N5BBDG-3402L3A											
36" x 24"	N5BBEE-3001L3A				N5BBEE-3002L3A				N5BBEE-3401L3A				N5BBEE-3402L3A											
36" x 27"	N5BBEG-3001L3A				N5BBEG-3002L3A				N5BBEG-3401L3A				N5BBEG-3402L3A											
42" x 24"	N5BBGE-3001L3A				N5BBGE-3002L3A				N5BBGE-3401L3A				N5BBGE-3402L3A											
42" x 27"	N5BBGG-3001L3A				N5BBGG-3002L3A				N5BBGG-3401L3A				N5BBGG-3402L3A											
48" x 24"	N5BBHE-3001L3A				N5BBHE-3002L3A				N5BBHE-3401L3A				N5BBHE-3402L3A											
48" x 27"	N5BBHG-3001L3A				N5BBHG-3002L3A				N5BBHG-3401L3A				N5BBHG-3402L3A											
54" x 24"	N5BBJE-3001L3A				N5BBJE-3002L3A				N5BBJE-3401L3A				N5BBJE-3402L3A											
54" x 27"	N5BBJG-3001L3A				N5BBJG-3002L3A				N5BBJG-3401L3A				N5BBJG-3402L3A											



PRECONFIGURED MODELS



CHANGE CART

Change carts are used for a specific purpose. They are the link between the central store and tool cabinets, which are located next to press brakes, so the cabinets can be filled and emptied on a daily basis.

They have a wider wheelbase at the front of the cart to ensure perfect stability. The cart top has an adjustable tool tray and laminated hardwood top for easy tool preparation.

- Preconfigured cart models have 6" casters, including two rigid and two swivel casters with total-lock brakes, as well as an integrated lock-in mechanism (A)
- All cabinets are fitted with a True One-Drawer-at-a-Time System
- 4 RF62 drawers (4"H) with RG07 partition
- 1 roll-out shelf (6"H)
- All cabinets include a standard cabinet lock
- To add an L50 electronic lock, [see page 45](#)
- Two versions of adjustable tool tray:
 - o 02 (1.0" / 10): recommended for American-type tools. Hollow depth: 1.030"
 - o 01 (1.5" / 15): recommended for European, Wilson WT, Wila NS, Trumpf type tools. Hollow depth: 1.468"

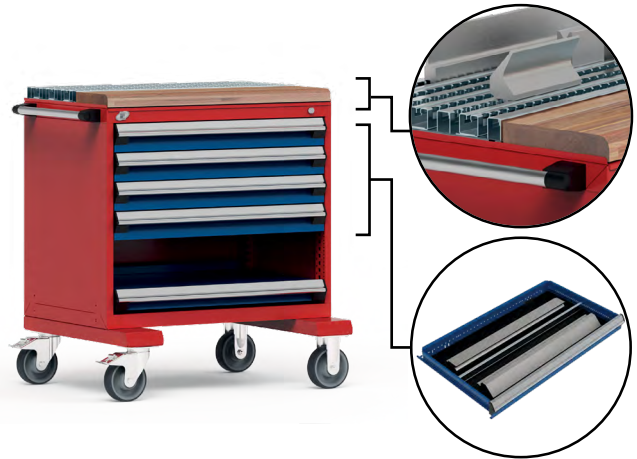

W×D×H	TRAY	PRODUCT NO.
36" 24" 41 1/4"	15	N5CBEE-3001L3A
	10	N5CBEE-3002L3A
42" 24" 41 1/4"	15	N5CBGE-3001L3A
	10	N5CBGE-3002L3A

NOTES: Refer to technical guide N55 to determine the tray best suited to your tool type.
 The usable height of each drawer is 1" inch less than its nominal height. Refer to the usable width to determine the usable dimensions you will have for your tools.
 Leave sufficient space for gripping your tools. We recommend 1 1/2" on either side of the tool.



Always distribute the load evenly to prevent the change cart from tipping.





VTZ CABINETS FOR BENDING TOOLS

With VTZ (Vertical Tool Zone) Vertical Storage, you can store many different tools in a relatively small floor area.

The shelves can be adjusted vertically in 3/4" increments c/c to accommodate the height of your tools. They can also support a load of 250lb. Each of the drawers features a floor rolling system that supports a 1,000lb. load in total.

For tool storage, the drawers include universal shelves (flat) and/or adjustable shelves (upright). Extra shelves can be added as needed.

- Two versions of adjustable tool tray:
 - o 1.0": recommended for American-type tools. Hollow depth: 1.030"
 - o 1.5": recommended for European, Wilson WT, Wila NS, Trumpf type tools. Hollow depth: 1.468"
- To order a drawer lock, add L3 to the product number
- To order a drawer locking system with latch, add LC to the product number



NO. OF DRAWERS	W	D	H	TRAY	LINEAR FEET	PRODUCT NO.
3	23 1/2"	44"	62"	Universal	40.25'	NCB-AH620001__
				1,0"	40.25'	NCB-AH621001__
				1,5"	40.25'	NCB-AH621501__
				Without	40.25'	NCV-AH629901__
				Universal	44.25'	NCB-AI620001__
				1,0"	44.25'	NCB-AI621001__
4	30 1/2"	44"	62"	1,5"	44.25'	NCB-AI621501__
				Without	44.25'	NCV-AI629901__
				Universal	53'	NCB-DH620001__
				1,0"	53'	NCB-DH621001__
				1,5"	53'	NCB-DH621501__
				Sans	53'	NCV-DH629901__
5	37 1/2"	44"	62"	Universal	59'	NCB-DI620001__
				1,0"	59'	NCB-DI621001__
				1,5"	59'	NCB-DI621501__
				Without	59'	NCV-DI629901__
				Universal	67'	NCB-GH620001__
				1,0"	67'	NCB-GH621001__
6	44 1/2"	44"	62"	1,5"	67'	NCB-GH621501__
				Without	67'	NCV-GH629901__
				Universal	74'	NCB-GI620001__
				1,0"	74'	NCB-GI621001__
				1,5"	74'	NCB-GI621501__
				Without	74'	NCV-GI629901__
6	44 1/2"	48"	62"	Universal	80.5'	NCB-JH620001__
				1,0"	80.5'	NCB-JH621001__
				1,5"	80.5'	NCB-JH621501__
				Without	80.5'	NCV-JH629901__
				Universal	88.5'	NCB-JI620001__
				1,0"	88.5'	NCB-JI621001__
6	44 1/2"	48"	62"	1,5"	88.5'	NCB-JI621501__
				Without	88.5'	NCV-JI629901__



L3 Lock



LC Latch



NCB-GI621001L3

NOTES: The width of your tools determines the depth of the VTZ cabinet to choose. Leave sufficient space for gripping your tools. We recommend 1 1/2" on either side of the tool.



COMPONENTS



BENDING TOOL SHELVES AND TRAYS

UNIVERSAL SHELF FOR VTZ CABINETS

- For storing punches and dies flat
- 4 3/16" W surface in the center for storing tools
- Can be used to store a variety of items

DEPTH	USABLE DEPTH	PRODUCT NO.
44"	40 1/4"	NC62-0704400
48"	44 1/4"	NC62-0704800

ADJUSTABLE SHELVES FOR VTZ CABINETS

- For storing punches and dies upright
- Can be adjusted to accommodate most tool tangs
- Includes a fixed central part and two adjustable parts on the sides. The position of the adjustable parts can be adjusted along the width (0.500" to 0.787") based on the tools stored by loosening the screws
- Includes perforations in the center where the tool's middle section can be clipped in if needed
- Two versions available:
 - o 10 (1.0"): recommended for American-type tools. Hollow depth: 1.030"
 - o 15 (1.5"): recommended for European, Wilson WT, Wila NS, Trumpf type tools. Hollow depth: 1.468"

DEPTH	USABLE DEPTH	TRAY	PRODUCT NO.
44"	40 1/4"	10	NC62-0704410
		15	NC62-0704415
48"	44 1/4"	10	NC62-0704810
		15	NC62-0704815

NOTE: Refer to technical guide N55 to determine the shelf best suited to your tool type.

Shelves for VTZ cabinets

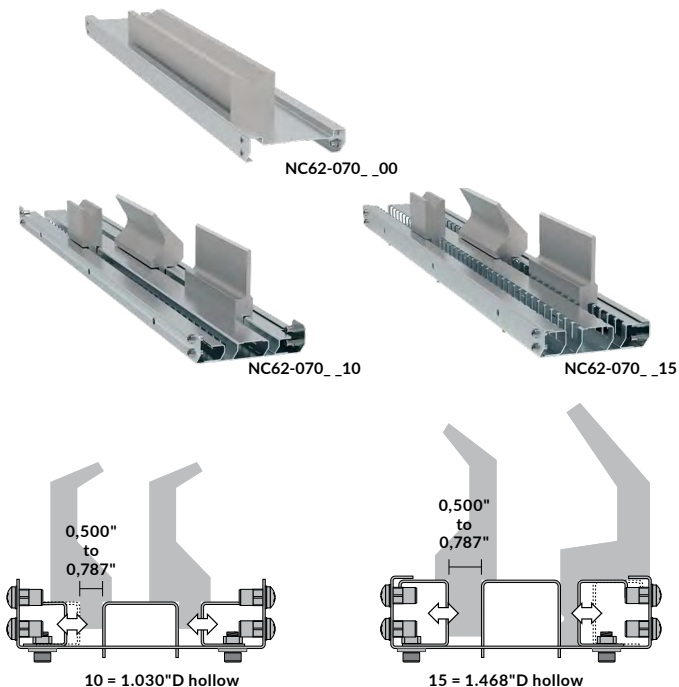

ADJUSTABLE TRAY FOR R DRAWERS

- Sits in the bottom of Rousseau heavy-duty drawers (RF31 and RF62).
- Multiple widths and depths are available so trays can be added to an existing Rousseau cabinet

NOTES: Refer to technical guide N55 to determine the tray best suited to your tool type. The usable height of each drawer is 1" inch less than its nominal height. Refer to the usable width to determine the usable dimensions you will have for your tools. Leave sufficient space for gripping your tools. We recommend 1 1/2" on either side of the tool.

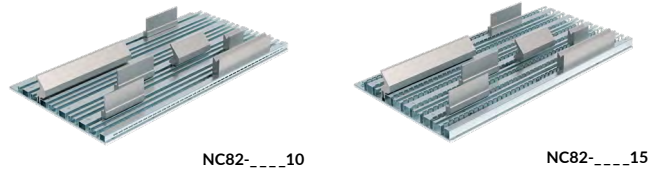

Trays for R drawers

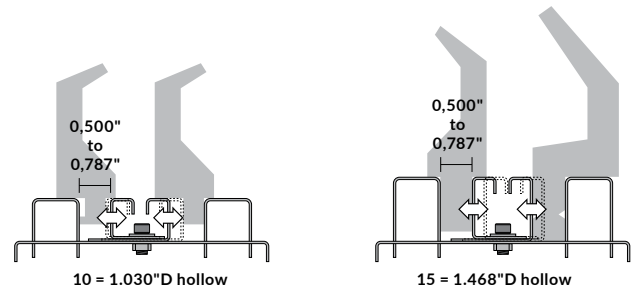

WIDTH	USABLE WIDTH	DEPTH	NO. OF HOLLOW	PRODUCT NO.
30"	25 1/2"	21"	6	NC82-302110
			6	NC82-302115
		27"	9	NC82-302710
			9	NC82-302715
36"	31 1/2"	21"	6	NC82-362110
			6	NC82-362115
		24"	8	NC82-362410
			8	NC82-362415
		27"	9	NC82-362710
			9	NC82-362715
42"	37 1/2"	24"	8	NC82-422410
			8	NC82-422415
		27"	9	NC82-422710
			9	NC82-422715
48"	43 1/2"	24"	8	NC82-482410
			8	NC82-482415
		27"	9	NC82-482710
			9	NC82-482715
		24"	8	NC82-542410
			8	NC82-542415
54"	49 1/2"	9	NC82-542710	
		9	NC82-542715	



DRAWER COMPONENTS

HEAVY-DUTY TOOL DRAWER

RF62

- Compatible with RG07 heavy-duty partitions
- 400lb. load capacity, 100% extension
- Heavy-duty construction
- Easy to install
- Maximizes use of space and limits wasted storage space
- Drawer heights available: 3", 4" and 5".
- To order: Specify the desired height (03", 04" or 05") and the lock-in mechanism if required, e.g., RF62-302403A

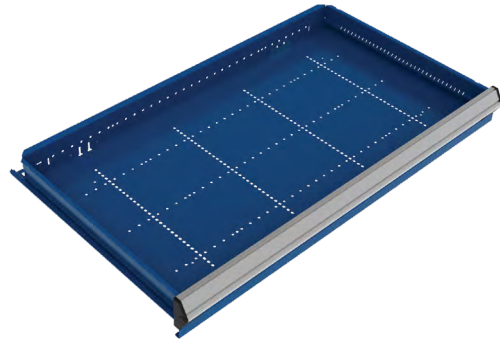

WIDTH	DEPTH	PRODUCT NO.
30"	24"	RF62-3024___
	27"	RF62-3027___
36"	24"	RF62-3624___
	27"	RF62-3627___
42"	24"	RF62-4224___
	27"	RF62-4227___
48"	24"	RF62-4824___
	27"	RF62-4827___
54"	24"	RF62-5424___
	27"	RF62-5427___

HEAVY-DUTY PARTITION FOR RF62 DRAWER

RG07

- For storing punches and dies flat
- Heavy-duty partitions (RG07) are used to separate tools and provide reinforcement at the bottom of the drawer to prevent it from buckling under a concentrated load
- Specially designed for tool drawers (RF62)
- Screws in from underneath and to one end of the drawer



WIDTH	USABLE WIDTH	PRODUCT NO.
30"	25½"	RG07-3003
36"	31½"	RG07-3603
42"	37½"	RG07-4203
48"	43½"	RG07-4803
54"	49½"	RG07-5403

RUBBER MAT

RG58

- ½" black neoprene mat for RF31 and RF62 drawers for protecting tools and items stored at the bottom of the drawer
- Installs between partitions (RG07)
- Installs underneath bending tool trays (NC82)

WIDTH	DEPTH	PRODUCT NO.
30"	24"	RG58-3024
	27"	RG58-3027
36"	24"	RG58-3624
	27"	RG58-3627
42"	24"	RG58-4224
	27"	RG58-4227
48"	24"	RG58-4824
	27"	RG58-4827
54"	24"	RG58-5424
	27"	RG58-5427

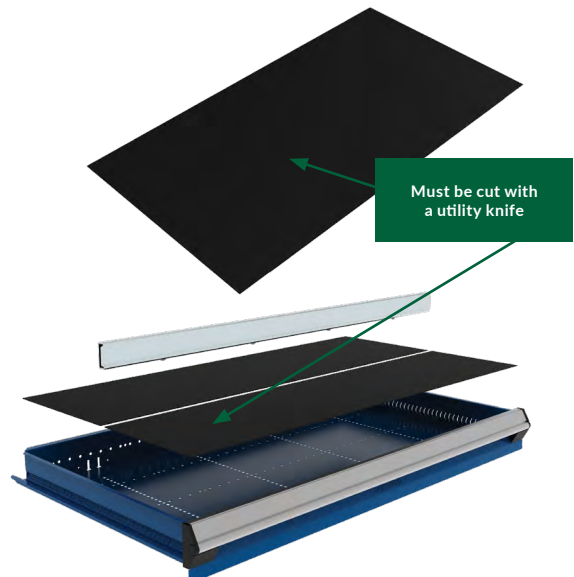

w.w.Cannon, Inc.

Design. Layout. Build. Install.

1-800-442-3061
www.wwcannon.com