



INDEX	PAGE(S)
Modular Drawer	218-223
Preconfigured Models . . .	224-241
Accessories . . . . .	242-247

## ROUSSEAU DRAWERS : BEST IN CLASS

### THE STURDIEST AND MOST DURABLE ON THE MARKET

Tested in an independent laboratory, Rousseau's modular drawer has demonstrated its superiority on many levels: loaded to full capacity, it completed a high number of cycles without showing any signs of wear. The Rousseau drawer reigns supreme in its category. Its superior performance and lifespan are a product of its durable and sturdy construction. In fact, we are so confident in its durability that we proudly offer a Lifetime Warranty on the drawer rolling mechanism – a promise worth investing in!

### A WIDE VARIETY OF ACCESSORIES

Rousseau drawers make your work easier: the many accessories available are all compatible with each other and help to keep your workspace organized and optimized. These accessories can also be easily rearranged according to your needs, and this extra convenience further boosts your productivity.

### STREAMLINED DESIGN

In addition to being sturdy and functional, Rousseau drawers have an attractive design. They look equally at home in an office or a factory, so you can create a harmonious and aesthetically pleasing workspace. The unique design of the R drawer is a trademark of Rousseau Metal Inc.



## THE ROUSSEAU DIFFERENCE



Supporting a 400 lb. load, the drawer can be opened thousands of times without showing signs of wear.



10 drawer heights

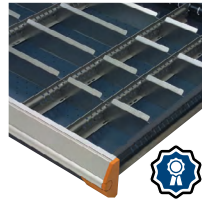

Partitions and dividers are clipped in



Rousseau name embossed on the front of each drawer. If you don't see ROUSSEAU, it's not a ROUSSEAU.

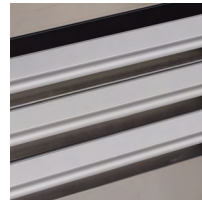

Stainless steel drawer fronts give high-class aesthetics to your cabinets and shelving. Excellent chemical and corrosion resistance.

## SMALL DETAILS THAT MAKE A BIG IMPACT

### ERGONOMIC

The full-width handle and accessories (integrated lock-in mechanism, lock-out mechanism, lock, etc.) have all been designed down to the smallest detail to make your work tasks easier.

### EFFICIENT

A wide range of accessories, such as partitions and dividers, plastic bins, groove trays, tool foam and hanging file bars help you to optimize your space for optimum efficiency.

### ACCESSIBLE

Drawers open 100% so you have full and unrestricted access to the contents.

### HEAVY-DUTY

400lb. load capacity per drawer.

### DURABLE

Our designers have created such a durable drawer that we proudly offer a Lifetime Warranty on the drawer rolling mechanism.

### INGENIOUS

Accessories can be added or removed at any time.



R5AEE-5825



R5SEE-874803

## 22 DRAWER SIZES × 10 HEIGHTS = 220 DIMENSIONS AVAILABLE

18" W



24" W



30" W

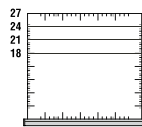

36" W

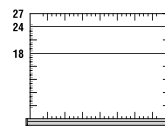

42" W

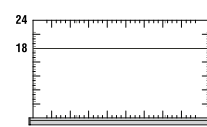

48" W

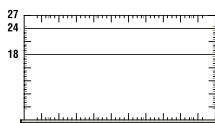

54" W

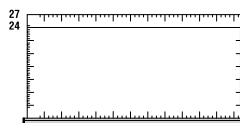

60" W

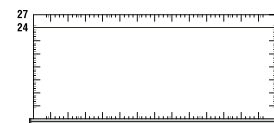

NOTE: The unique design of the R drawer is a trademark of Rousseau Metal Inc.

# MODULAR DRAWER

## MODULAR DRAWERS AND ROLL-OUT SHELVES

### HEAVY-DUTY MODULAR DRAWER



- Painted steel drawer for cabinets (and multi-drawer cabinets): RF31
- Painted steel drawer for shelving: RF32
- Drawer with stainless steel front and gray painted steel interior for cabinets (and multi-drawer cabinets): RF35
- Drawer with stainless steel front and gray painted steel interior for shelving: RF36
- 400lb. load capacity, 100% extension
- Heavy-duty construction
- Easy to install
- Vast choice of accessories available to customize the drawer to your storage needs, [see pages 242-247](#)
- Drawer heights available: 3", 4", 5", 6", 7", 8", 9", 10", 12" and 14"
- To order: Add the drawer height to the product number.
- For preconfigured modular drawers with compartments, [see pages 224-241](#)

### HEAVY-DUTY FRONT-ACCESS ROLL-OUT SHELF



- Roll-out shelf for cabinets (and multi-drawer cabinets): RF40
- Roll-out shelf for shelving: RF41
- 400lb. load capacity, 100% extension
- Heavy-duty construction
- Easy to install
- Painted steel with 3"H edges on the sides and back
- Total height: 6"
- Full access to contents

### HEAVY-DUTY 3-SIDED-ACCESS ROLL-OUT SHELF



- 3-sided-access roll-out shelf for cabinets (and multi-drawer cabinets): RF44
- 3-sided-access roll-out shelf for shelving: RF45
- 400lb. load capacity, 100% extension
- Heavy-duty construction
- Easy to install
- Galvanized steel with 1½"H back edge
- Total height: 5"
- Can be used as a work surface

#### IMPORTANT

For available dimensions according to use (cabinet or shelving), [see pages 221-222.](#)

## DRAWER AND ROLL-OUT SHELF DIMENSIONS

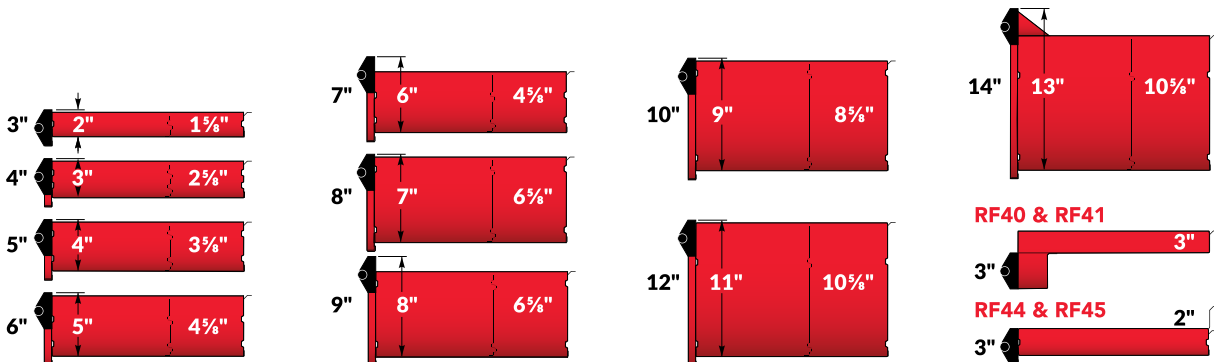

**18" x 21"**

**CABINET**  
 RF31-1821 \_\_  
 RF35-1821 \_\_  
 RF40-1821  
 RF44-1821

**18" x 24"**

**MULTI-DRAWER**  
 See pages  
 66-75

**18" x 27"**

**CABINET**  
 RF31-1827 \_\_  
 RF35-1827 \_\_  
 RF40-1827  
 RF44-1827

**MULTI-DRAWER**  
 See pages  
 66-75

**24" x 21"**

**CABINET**  
 RF31-2421 \_\_  
 RF35-2421 \_\_  
 RF40-2421  
 RF44-2421

**24" x 24"**

**MULTI-DRAWER**  
 See pages  
 66-75

**24" x 27"**

**CABINET**  
 RF31-2427 \_\_  
 RF35-2427 \_\_  
 RF40-2427  
 RF44-2427

**MULTI-DRAWER**  
 See pages  
 66-75

**30" x 18"**

**SHELVING**  
 RF32-3018 \_\_  
 RF36-3018 \_\_  
 RF41-3018  
 RF45-3018

**30" x 21"**

**CABINET**  
 RF31-3021 \_\_  
 RF35-3021 \_\_  
 RF40-3021  
 RF44-3021

**30" x 24"**

**SHELVING**  
 RF32-3024 \_\_  
 RF36-3024 \_\_  
 RF41-3024  
 RF45-3024

**MULTI-DRAWER**  
 See pages  
 66-75

**30" x 27"**

**CABINET**  
 RF31-3027 \_\_  
 RF35-3027 \_\_  
 RF40-3027  
 RF44-3027

**MULTI-DRAWER**  
 See pages  
 66-75

**36" x 18"**

**CABINET**  
 RF31-3618 \_\_  
 RF35-3618 \_\_  
 RF40-3618  
 RF44-3618

**SHELVING**  
 RF32-3618 \_\_  
 RF36-3618 \_\_  
 RF41-3618  
 RF45-3618

**36" x 24"**

**CABINET**  
 RF31-3624 \_\_  
 RF35-3624 \_\_  
 RF40-3624  
 RF44-3624

**SHELVING**  
 RF32-3624 \_\_  
 RF36-3624 \_\_  
 RF41-3624  
 RF45-3624

**MULTI-DRAWER**  
 See pages  
 66-75

**36" x 27"**

**CABINET**  
 RF31-3627 \_\_  
 RF35-3627 \_\_  
 RF40-3627  
 RF44-3627

**MULTI-DRAWER**  
 See pages  
 66-75

# MODULAR DRAWER

42" x 18"

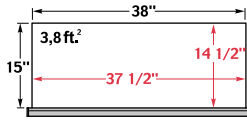

**SHELVING**

- RF32-4218 \_\_
- RF36-4218 \_\_
- RF41-4218
- RF45-4218

42" x 24"

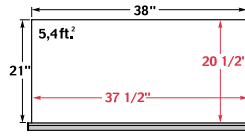

**SHELVING**

- RF32-4224 \_\_
- RF36-4224 \_\_
- RF41-4224
- RF45-4224



R5KKE-4403

48" x 18"

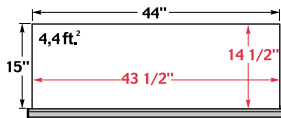

**SHELVING**

- RF32-4818 \_\_
- RF36-4818 \_\_
- RF41-4818
- RF45-4818

48" x 24"

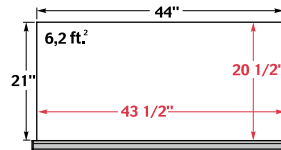

**CABINET**

- RF31-4824 \_\_
- RF35-4824 \_\_
- RF40-4824
- RF44-4824

**SHELVING**

- RF32-4824 \_\_
- RF36-4824 \_\_
- RF41-4824
- RF45-4824

**MULTI-DRAWER**

See pages  
66-75

48" x 27"

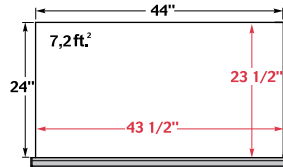

**CABINET**

- RF31-4827 \_\_
- RF35-4827 \_\_
- RF40-4827
- RF44-4827

**MULTI-DRAWER**

See pages  
66-75

54" x 24"

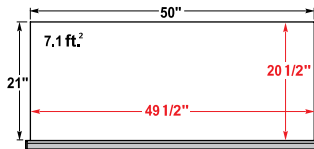

**CABINET**

- RF31-5424 \_\_
- RF35-5424 \_\_
- RF40-5424
- RF44-5424

**MULTI-DRAWER**

See pages  
66-75

54" x 27"

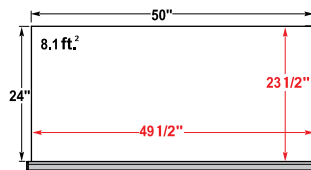

**CABINET**

- RF31-5427 \_\_
- RF35-5427 \_\_
- RF40-5427
- RF44-5427

**MULTI-DRAWER**

See pages  
66-75

60" x 24"

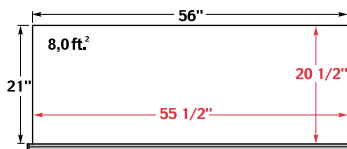

**CABINET**

- RF31-6024 \_\_
- RF35-6024 \_\_
- RF40-6024
- RF44-6024

**MULTI-DRAWER**

See pages  
66-75

60" x 27"

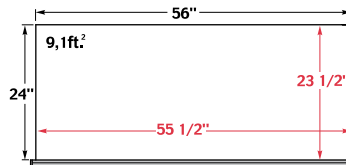

**CABINET**

- RF31-6027 \_\_
- RF35-6027 \_\_
- RF40-6027
- RF44-6027

**MULTI-DRAWER**

See pages  
66-75

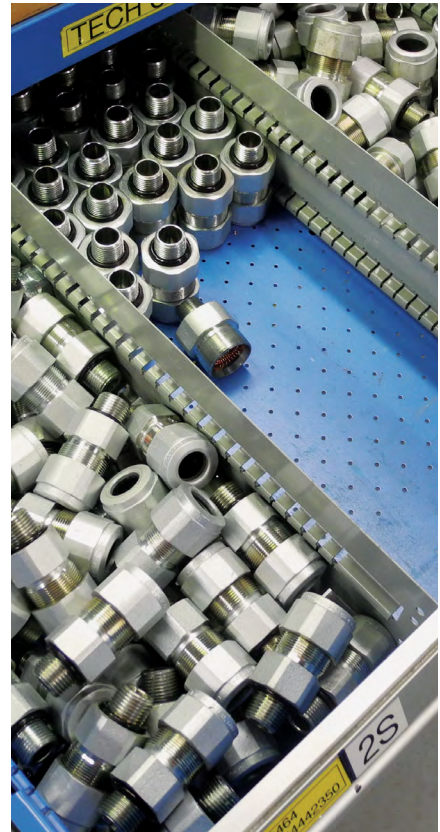

## HOW TO ORDER A DRAWER

### CHOOSE DRAWERS FROM OUR SELECTION OF PRECONFIGURED COMPARTMENT LAYOUTS

- 00 for subdividing kit only
- 51 for a painted steel drawer for cabinets – with compartments
- 52 for a painted steel drawer for shelving – with compartments
- See pages 224-241

R EE-A0200

Drawer height, see page 220

Locking or security mechanism, see page 247

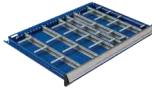

e.g., R52EE-A020006 L3A

For a 36"W x 24"D painted steel drawer for shelving with compartments, 6"H drawer, an L3 lock on the drawer and integrated lock-in mechanism

### CREATE A CUSTOM MODEL BY CHOOSING AN EMPTY DRAWER AND ADDING SUBDIVIDING ACCESSORIES

- 31 for a painted steel drawer for cabinets
- 32 for a painted steel drawer for shelving
- 35 for a drawer for cabinets with stainless steel front
- 36 for a drawer for shelving with stainless steel front

RF - 3624

Drawer height, see page 220

Locking or security mechanism, see page 247



e.g., RF31-362406 L3A

For a 36" W x 24" D painted steel drawer for cabinets, 6"H drawer, an L3 lock on the drawer and integrated lock-in mechanism

NOTE: Accessories must be ordered separately, see pages 242-247.

### TO CALCULATE DRAWER COMPARTMENT DIMENSIONS, REFER TO THE FOLLOWING ILLUSTRATION

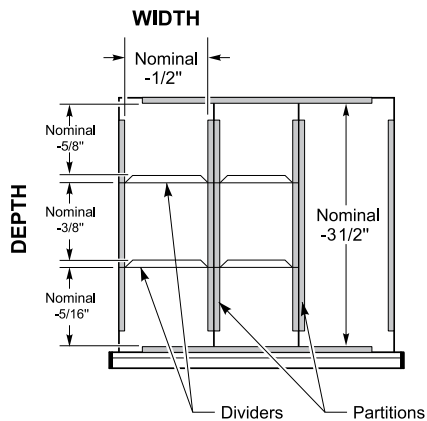

### DRAWER DIMENSIONS

		INSIDE WIDTH							
		14"	20"	26"	32"	38"	44"	50"	56"
OUTSIDE DEPTH	27"	18"x27"	24"x27"	30"x27"	36"x27"	48"x27"		54"x27"	60"x27"
	24"	18"x24"	24"x24"	30"x24"	36"x24"	42"x24"	48"x24"	54"x24"	60"x24"
INSIDE DEPTH	21"	18"x21"	24"x21"	30"x21"	42"x21"		48"x21"		
	18"			30"x18"	36"x18"	42"x18"	48"x18"		
		OUTSIDE WIDTH							
		24"	30"	36"	42"	48"	54"	60"	

## HOW TO ORDER A ROLL-OUT SHELF

### COMPLETE THE FIRST PART OF THE PRODUCT NUMBER WITH THE TYPE OF ROLL-OUT SHELF REQUIRED

- 40 for a roll-out shelf for cabinets
- 41 for a roll-out shelf for shelving
- 44 for a 3-sided-access roll-out shelf for cabinets
- 45 for a 3-sided-access roll-out shelf for shelving

RF - 3624

Locking or security mechanism, see page 247

e.g., RF41-3624A

For a roll-out shelf for shelving with an integrated lock-in mechanism



R5XEE-2002

# PRECONFIGURED MODELS

## 18"W x 21"D DRAWER – CABINETS

### PARTITIONS AND DIVIDERS

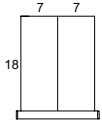

R\_\_BD-A0100\_\_  
2 COMPARTMENTS

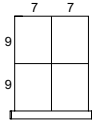

R\_\_BD-A0102\_\_  
4 COMPARTMENTS

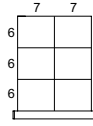

R\_\_BD-A0104\_\_  
6 COMPARTMENTS

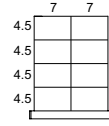

R\_\_BD-A0106\_\_  
8 COMPARTMENTS

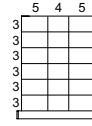

R\_\_BD-A0215\_\_  
18 COMPARTMENTS

### PLASTIC BINS<sup>2</sup>

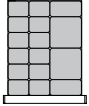

R\_\_BD-E016\_\_  
16 BINS

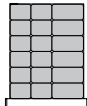

R\_\_BD-E018\_\_  
18 BINS

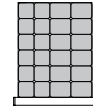

R\_\_BD-E024\_\_  
24 BINS

### FOAM<sup>2</sup>



R\_\_BD-J01\_\_  
PROTECTIVE FOAM

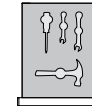

R\_\_BD-J02\_\_  
TOOL FOAM



### GROOVE TRAYS<sup>1,2</sup>

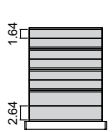

R\_\_BD-TD08\_\_  
8 GROOVE TRAYS

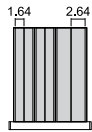

R\_\_BD-TW06\_\_  
6 GROOVE TRAYS

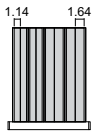

R\_\_BD-TW08\_\_  
8 GROOVE TRAYS

### HANGING FILE BARS<sup>3</sup>

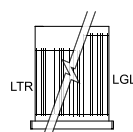

R\_\_BD-KLR\_\_  
WIDTH

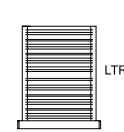

R\_\_BD-KFB\_\_  
DEPTH

## 18"W x 24"D DRAWER – MULTI-DRAWER

### PARTITIONS AND DIVIDERS

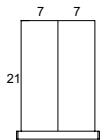

R\_\_BE-A0100\_\_  
2 COMPARTMENTS

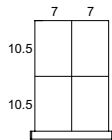

R\_\_BE-A0102\_\_  
4 COMPARTMENTS

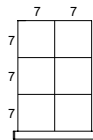

R\_\_BE-A0104\_\_  
6 COMPARTMENTS

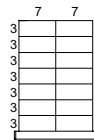

R\_\_BE-A0112\_\_  
14 COMPARTMENTS

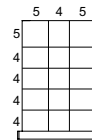

R\_\_BE-A0212\_\_  
15 COMPARTMENTS

### PLASTIC BINS<sup>2</sup>

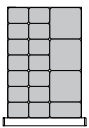

R\_\_BE-E018\_\_  
18 BINS

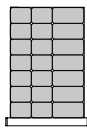

R\_\_BE-E021\_\_  
21 BINS

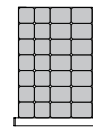

R\_\_BE-E028\_\_  
28 BINS

### FOAM<sup>2</sup>



R\_\_BE-J01\_\_  
PROTECTIVE FOAM

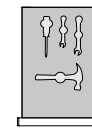

R\_\_BE-J02\_\_  
TOOL FOAM



### GROOVE TRAYS<sup>1,2</sup>

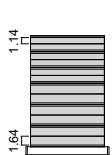

R\_\_BE-TD12\_\_  
12 GROOVE TRAYS

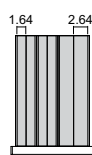

R\_\_BE-TW06\_\_  
6 GROOVE TRAYS

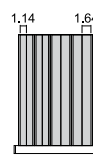

R\_\_BE-TW08\_\_  
8 GROOVE TRAYS

### HANGING FILE BARS<sup>3</sup>

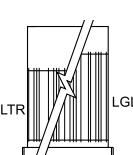

R\_\_BE-KFB\_\_  
WIDTH

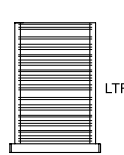

R\_\_BE-KLR\_\_  
DEPTH

NOTES: <sup>1</sup> Two dividers included with each groove. <sup>2</sup> Available for 3"H and 4"H drawers. <sup>3</sup> Available for 12"H and 14"H drawers.

## 18"W x 27"D DRAWERS – CABINETS / MULTI-DRAWER

### PARTITIONS AND DIVIDERS

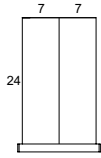

R\_\_BG-A0100\_\_  
2 COMPARTMENTS

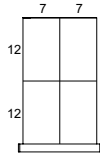

R\_\_BG-A0102\_\_  
4 COMPARTMENTS

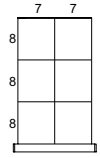

R\_\_BG-A0104\_\_  
6 COMPARTMENTS

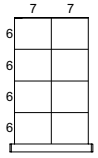

R\_\_BG-A0106\_\_  
8 COMPARTMENTS

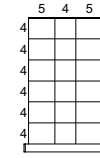

R\_\_BG-A0215\_\_  
18 COMPARTMENTS

### PLASTIC BINS<sup>2</sup>

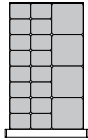

R\_\_BG-E020\_\_  
20 BINS

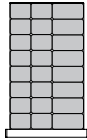

R\_\_BG-E024\_\_  
24 BINS

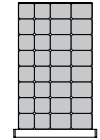

R\_\_BG-E032\_\_  
32 BINS

### FOAM<sup>2</sup>

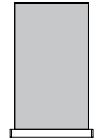

R\_\_BG-J01\_\_  
PROTECTIVE FOAM

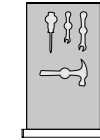

R\_\_BG-J02\_\_  
TOOL FOAM



### GROOVE TRAYS<sup>1,2</sup>

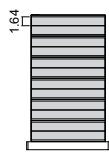

R\_\_BG-TD12\_\_  
12 GROOVE TRAYS

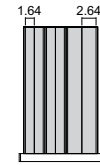

R\_\_BG-TW06\_\_  
6 GROOVE TRAYS

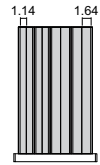

R\_\_BG-TW08\_\_  
8 GROOVE TRAYS

### HANGING FILE BARS<sup>3</sup>

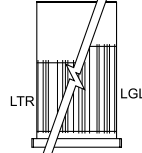

R\_\_BG-KLR\_\_  
WIDTH

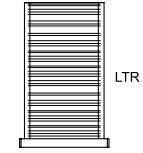

R\_\_BG-KFB\_\_  
DEPTH

## 24"W x 21"D DRAWERS – CABINETS

### PARTITIONS AND DIVIDERS

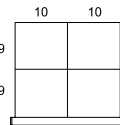

R\_\_CD-A0102\_\_  
4 COMPARTMENTS

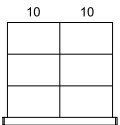

R\_\_CD-A0104\_\_  
6 COMPARTMENTS

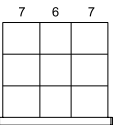

R\_\_CD-A0206\_\_  
9 COMPARTMENTS

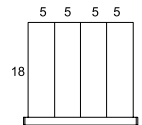

R\_\_CD-A0300\_\_  
4 COMPARTMENTS

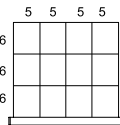

R\_\_CD-A0308\_\_  
12 COMPARTMENTS

### PLASTIC BINS<sup>2</sup>

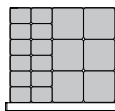

R\_\_CD-E018\_\_  
18 BINS

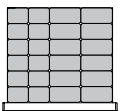

R\_\_CD-E024\_\_  
24 BINS

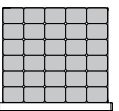

R\_\_CD-E030\_\_  
30 BINS

### FOAM<sup>2</sup>



R\_\_CD-J01\_\_  
PROTECTIVE FOAM

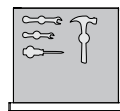

R\_\_CD-J02\_\_  
TOOL FOAM



### GROOVE TRAYS<sup>1,2</sup>

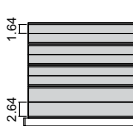

R\_\_CD-TD08\_\_  
8 GROOVE TRAYS

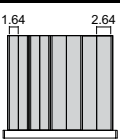

R\_\_CD-TW08\_\_  
8 GROOVE TRAYS

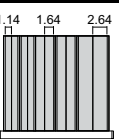

R\_\_CD-TW10\_\_  
10 GROOVE TRAYS

### HANGING FILE BARS<sup>3</sup>



R\_\_CD-KLR\_\_  
WIDTH

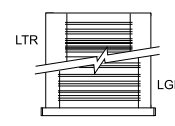

R\_\_CD-KFB\_\_  
DEPTH

NOTES: <sup>1</sup> Two dividers included with each groove. <sup>2</sup> Available for 3"H and 4"H drawers. <sup>3</sup> Available for 12"H and 14"H drawers.



# PRECONFIGURED MODELS

## 24"W x 24"D DRAWERS – MULTI-DRAWER

### PARTITIONS AND DIVIDERS

<p>R__CE-A0104__ 6 COMPARTMENTS</p>	<p>R__CE-A0200__ 3 COMPARTMENTS</p>	<p>R__CE-A0206__ 9 COMPARTMENTS</p>	<p>R__CE-A0304__ 8 COMPARTMENTS</p>	<p>R__CE-A0308__ 12 COMPARTMENTS</p>	<p>R__CE-C0408__ 13 COMPARTMENTS</p>
---	---	---	---	--	--

### PLASTIC BINS<sup>2</sup>

<p>R__CE-E022__ 22 BINS</p>	<p>R__CE-E028__ 28 BINS</p>	<p>R__CE-E035__ 35 BINS</p>
---------------------------------	---------------------------------	---------------------------------

### FOAM<sup>2</sup>

<p>R__CE-J01__ PROTECTIVE FOAM</p>	<p>R__CE-J02__ TOOL FOAM</p>
--	----------------------------------



### GROOVE TRAYS<sup>1,2</sup>

<p>R__CE-TD120__ 12 GROOVE TRAYS</p>	<p>R__CE-TW08__ 8 GROOVE TRAYS</p>	<p>R__CE-TW10__ 10 GROOVE TRAYS</p>
--	--	---

### HANGING FILE BARS<sup>3</sup>

<p>R__CE-KLR__ WIDTH</p>	<p>R__CE-KFB__ DEPTH</p>
------------------------------	------------------------------

NOTES: <sup>1</sup>Two dividers included with each groove. <sup>2</sup> Available for 3"H and 4"H drawers. <sup>3</sup> Available for 12"H and 14"H drawers.



## 24"W x 27"D DRAWERS – CABINETS / MULTI-DRAWER

### PARTITIONS AND DIVIDERS

R_CG-A0104__ 6 COMPARTMENTS	R_CG-A0206__ 9 COMPARTMENTS	R_CG-A0209__ 12 COMPARTMENTS	R_CG-A0308__ 12 COMPARTMENTS	R_CG-A0312__ 16 COMPARTMENTS	R_CG-A0316__ 20 COMPARTMENTS

### PLASTIC BINS<sup>2</sup>

R_CG-E024__ 24 BINS	R_CG-E032__ 32 BINS	R_CG-E040__ 40 BINS

### FOAM<sup>2</sup>

R_CG-J01__ PROTECTIVE FOAM	R_CG-J02__ TOOL FOAM



### GROOVE TRAYS<sup>1,2</sup>

R_CG-TD10__ 10 GROOVE TRAYS	R_CG-TW08__ 8 GROOVE TRAYS	R_CG-TW10__ 10 GROOVE TRAYS

### HANGING FILE BARS<sup>3</sup>

R_CG-KLR__ WIDTH	R_CG-KFB__ DEPTH

## 30"W x 18"D DRAWERS – SHELVING

### PARTITIONS AND DIVIDERS

R_DC-A0102__ 4 COMPARTMENTS	R_DC-A0308__ 12 COMPARTMENTS	R_DC-A0512__ 18 COMPARTMENTS	R_DC-A0414__ 19 COMPARTMENTS	R_DC-A0418__ 23 COMPARTMENTS

### PLASTIC BINS<sup>2</sup>

R_DC-E019__ 19 BINS	R_DC-E025__ 25 BINS	R_DC-E035__ 35 BINS

### FOAM<sup>2</sup>

R_DC-J01__ PROTECTIVE FOAM	R_DC-J02__ TOOL FOAM



### GROOVE TRAYS<sup>1,2</sup>

R_DC-TD08__ 8 GROOVE TRAYS	R_DC-TW10__ 10 GROOVE TRAYS	R_DC-TW12__ 12 GROOVE TRAYS	R_DC-TW14__ 14 GROOVE TRAYS

### HANGING FILE BARS<sup>3</sup>

R_DC-KLR__ WIDTH	R_DC-KFB__ DEPTH

NOTES: <sup>1</sup> Two dividers included with each groove. <sup>2</sup> Available for 3"H and 4"H drawers. <sup>3</sup> Available for 12"H and 14"H drawers.

# PRECONFIGURED MODELS

## 30"W x 21"D DRAWERS – CABINETS

PARTITIONS AND DIVIDERS					
R_DD-A0102_	R_DD-A0203_	R_DD-A0206_	R_DD-A0308_	R_DD-A0518_	R_DD-D0411_
4 COMPARTMENTS	6 COMPARTMENTS	9 COMPARTMENTS	12 COMPARTMENTS	24 COMPARTMENTS	16 COMPARTMENTS
PLASTIC BINS <sup>2</sup>			FOAM <sup>2</sup>		
R_DD-E021_	R_DD-E030_	R_DD-E036_	R_DD-J01_	R_DD-J02_	
21 BINS	30 BINS	36 BINS	PROTECTIVE FOAM	TOOL FOAM	
GROOVE TRAYS <sup>1</sup>				HANGING FILE BARS <sup>3</sup>	
R_DD-TD08_	R_DD-TW10_	R_DD-TW12_	R_DD-TW14_	R_DD-KLR_	R_DD-KFB_
8 GROOVE TRAYS	10 GROOVE TRAYS	12 GROOVE TRAYS	14 GROOVE TRAYS	WIDTH	DEPTH

## 30"W x 24"D DRAWERS – SHELVING / MULTI-DRAWER

PARTITIONS AND DIVIDERS		PLASTIC BINS <sup>2</sup>	FOAM <sup>2</sup>	GROOVE TRAYS <sup>1,2</sup>	
R_DE-A0102_	R_DE-A0206_	R_DE-E026_	R_DE-J01_	R_DE-TD12_	R_DE-TW10_
4 COMPARTMENTS	9 COMPARTMENTS	26 BINS	PROTECTIVE FOAM	12 GROOVE TRAYS	10 GROOVE TRAYS
R_DE-A0300_	R_DE-A0308_	R_DE-E035_	R_DE-J02_	R_DE-TW12_	R_DE-TW14_
4 COMPARTMENTS	12 COMPARTMENTS	35 BINS	TOOL FOAM	12 GROOVE TRAYS	14 GROOVE TRAYS
R_DE-A0524_	R_DE-B0200_	R_DE-E042_	R_DE-J03_	R_DE-KLR_	R_DE-KFB_
30 COMPARTMENTS	3 COMPARTMENTS	42 BINS	COLLET FOAM	WIDTH	DEPTH
R_DE-C0408_	R_DE-D0527_				
13 COMPARTMENTS	33 COMPARTMENTS				

NOTES: <sup>1</sup> Two dividers included with each groove. <sup>2</sup> Available for 3"H and 4"H drawers. <sup>3</sup> Available for 12"H and 14"H drawers.

## 30"W x 27"D DRAWERS – CABINETS / MULTI-DRAWER

### PARTITIONS AND DIVIDERS

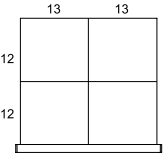
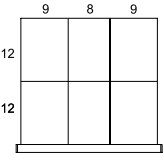
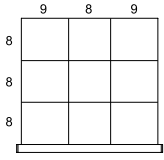
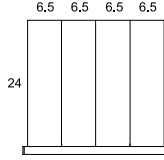
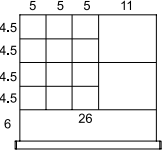
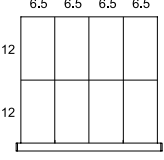
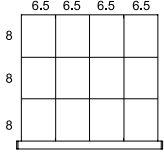
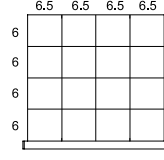
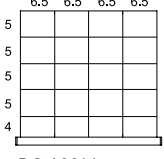
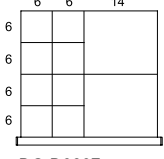
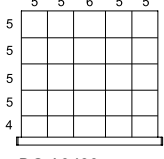
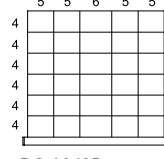
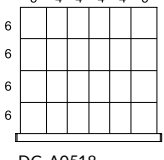
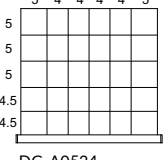
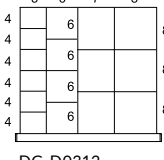
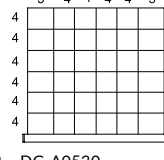
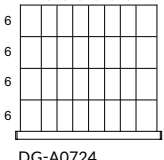
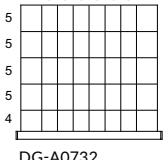
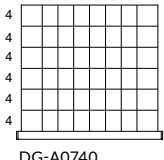
 R_DG-A0102_ 4 COMPARTMENTS	 R_DG-A0203_ 6 COMPARTMENTS	 R_DG-A0206_ 9 COMPARTMENTS	 R_DG-A0300_ 4 COMPARTMENTS
 R_DG-C0410_ 15 COMPARTMENTS	 R_DG-A0304_ 8 COMPARTMENTS	 R_DG-A0308_ 12 COMPARTMENTS	 R_DG-A0312_ 16 COMPARTMENTS
 R_DG-A0316_ 20 COMPARTMENTS	 R_DG-D0207_ 10 COMPARTMENTS	 R_DG-A0420_ 25 COMPARTMENTS	 R_DG-A0425_ 30 COMPARTMENTS
 R_DG-A0518_ 24 COMPARTMENTS	 R_DG-A0524_ 30 COMPARTMENTS	 R_DG-D0312_ 16 COMPARTMENTS	 R_DG-A0530_ 36 COMPARTMENTS
 R_DG-A0724_ 32 COMPARTMENTS	 R_DG-A0732_ 40 COMPARTMENTS	 R_DG-A0740_ 48 COMPARTMENTS	

### GROOVE TRAYS<sup>1,2</sup>

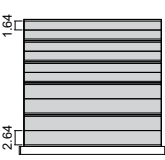
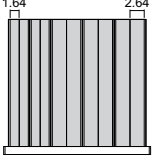
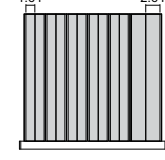
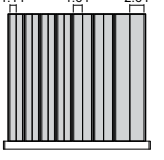
 R_DG-TD10_ 10 GROOVE TRAYS	 R_DG-TW10_ 10 GROOVE TRAYS
 R_DG-TW12_ 12 GROOVE TRAYS	 R_DG-TW14_ 14 GROOVE TRAYS

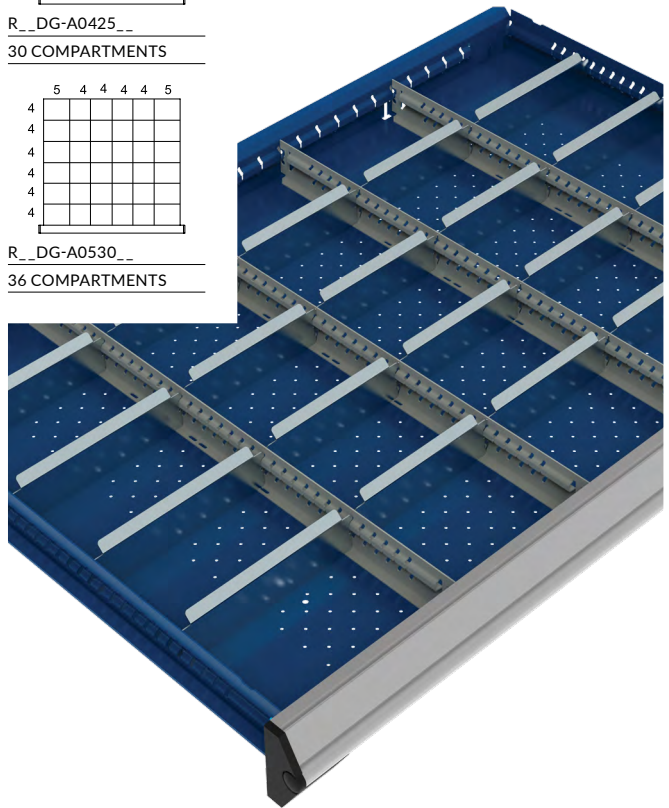

### PLASTIC BINS<sup>2</sup>

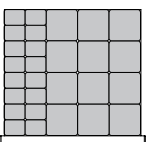
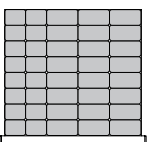
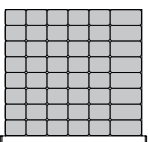
 R_DG-E028_ 28 BINS	 R_DG-E040_ 40 BINS	 R_DG-E048_ 48 BINS
--	--	--

### FOAM<sup>2</sup>

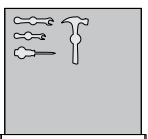
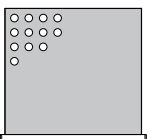
 R_DG-J01_ PROTECTIVE FOAM	 R_DG-J02_ TOOL FOAM	 R_DG-J03_ COLLET FOAM
---	---	---

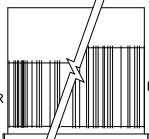
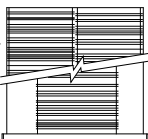

### HANGING FILE BARS<sup>3</sup>

 R_DG-KLR_ WIDTH	 R_DG-KFB_ DEPTH
---	---

NOTES: <sup>1</sup> Two dividers included with each groove. <sup>2</sup> Available for 3"H and 4"H drawers. <sup>3</sup> Available for 12"H and 14"H drawers.

# PRECONFIGURED MODELS

## 36"W x 18"D DRAWERS – CABINETS / SHELVING

### PARTITIONS AND DIVIDERS

R_EC-A0200_	R_EC-A0203_	R_EC-A0206_	R_EC-A0209_	R_EC-A0300_	R_EC-A0304_
3 COMPARTMENTS	6 COMPARTMENTS	9 COMPARTMENTS	12 COMPARTMENTS	4 COMPARTMENTS	8 COMPARTMENTS
R_EC-A0308_	R_EC-A0312_	R_EC-A0400_	R_EC-A0405_	R_EC-A0410_	R_EC-A0415_
12 COMPARTMENTS	16 COMPARTMENTS	5 COMPARTMENTS	10 COMPARTMENTS	15 COMPARTMENTS	20 COMPARTMENTS
R_EC-A0500_	R_EC-A0506_	R_EC-A0512_	R_EC-A0518_	R_EC-A0524_	R_EC-A0700_
6 COMPARTMENTS	12 COMPARTMENTS	18 COMPARTMENTS	24 COMPARTMENTS	30 COMPARTMENTS	8 COMPARTMENTS
R_EC-A0708_	R_EC-A0716_	R_EC-A0724_			
16 COMPARTMENTS	24 COMPARTMENTS	32 COMPARTMENTS			



### PLASTIC BINS<sup>2</sup>

R_EC-E022_	R_EC-E030_	R_EC-E040_
22 BINS	30 BINS	40 BINS

### FOAM<sup>2</sup>



R\_EC-J01\_  
PROTECTIVE FOAM

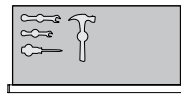

R\_EC-J02\_  
TOOL FOAM

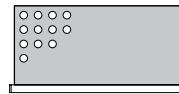

R\_EC-J03\_  
COLLET FOAM



### GROOVE TRAYS<sup>1,2</sup>

R_EC-TD08_	R_EC-TW12_	R_EC-TW16_
8 GROOVE TRAYS	12 GROOVE TRAYS	16 GROOVE TRAYS

### HANGING FILE BARS<sup>3</sup>

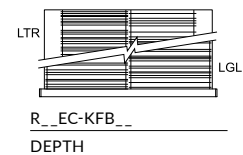
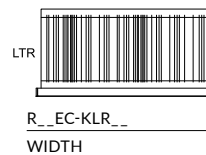

NOTES: <sup>1</sup> Two dividers included with each groove. <sup>2</sup> Available for 3"H and 4"H drawers. <sup>3</sup> Available for 12"H and 14"H drawers.

## 36"W x 24"D DRAWERS – CABINETS / SHELVING / MULTI-DRAWER

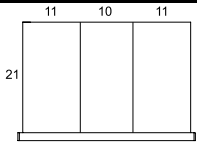
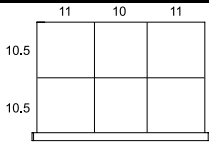
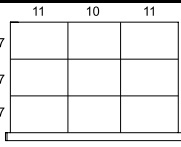
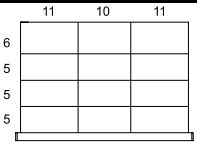
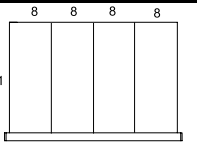
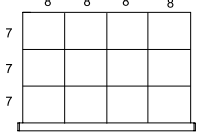
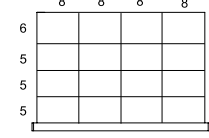
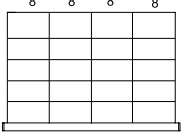
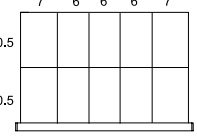
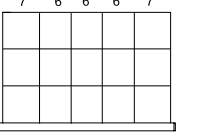
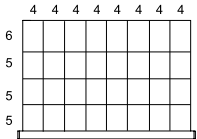
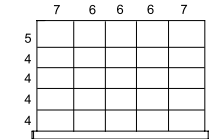
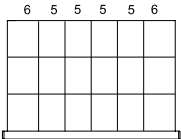
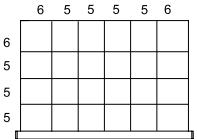
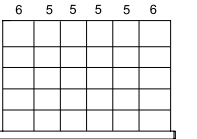
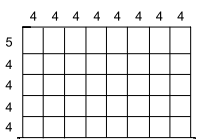
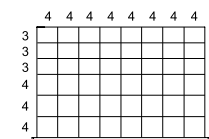
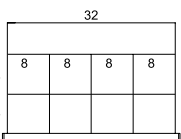
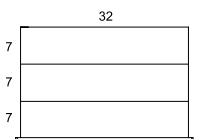
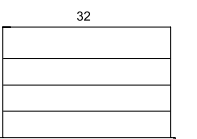

### PARTITIONS AND DIVIDERS

 <p>R_EE-A0200_ 3 COMPARTMENTS</p>	 <p>R_EE-A0203_ 6 COMPARTMENTS</p>	 <p>R_EE-A0206_ 9 COMPARTMENTS</p>	 <p>R_EE-A0209_ 12 COMPARTMENTS</p>	 <p>R_EE-A0300_ 4 COMPARTMENTS</p>
 <p>R_EE-A0308_ 12 COMPARTMENTS</p>	 <p>R_EE-A0312_ 16 COMPARTMENTS</p>	 <p>R_EE-A0316_ 20 COMPARTMENTS</p>	 <p>R_EE-A0405_ 10 COMPARTMENTS</p>	 <p>R_EE-A0410_ 15 COMPARTMENTS</p>
 <p>R_EE-A0724_ 32 COMPARTMENTS</p>	 <p>R_EE-A0420_ 25 COMPARTMENTS</p>	 <p>R_EE-A0512_ 18 COMPARTMENTS</p>	 <p>R_EE-A0518_ 24 COMPARTMENTS</p>	 <p>R_EE-A0524_ 30 COMPARTMENTS</p>
 <p>R_EE-A0732_ 40 COMPARTMENTS</p>	 <p>R_EE-A0740_ 48 COMPARTMENTS</p>	 <p>R_EE-C0404_ 9 COMPARTMENTS</p>	 <p>R_EE-B0200_ 3 COMPARTMENTS</p>	 <p>R_EE-B0300_ 4 COMPARTMENTS</p>

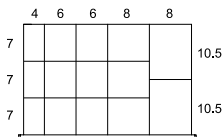
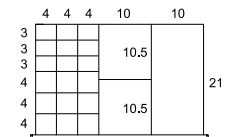
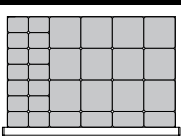
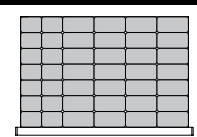
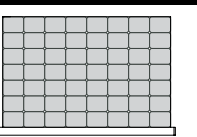
### PLASTIC BINS<sup>2</sup>

 <p>R_EE-D0409_ 14 COMPARTMENTS</p>	 <p>R_EE-D0416_ 21 COMPARTMENTS</p>	 <p>R_EE-E030_ 30 BINS</p>	 <p>R_EE-E042_ 42 BINS</p>	 <p>R_EE-E056_ 56 BINS</p>
--	--	---	--	---

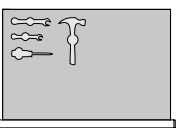
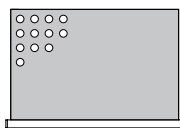
### FOAM<sup>2</sup>

 <p>R_EE-J01_ PROTECTIVE FOAM</p>	 <p>R_EE-J02_ TOOL FOAM</p>	 <p>R_EE-J03_ COLLET FOAM</p>	 <p>Sold without cut-outs</p>
--	--	---	--

### GROOVE TRAYS<sup>1,2</sup>

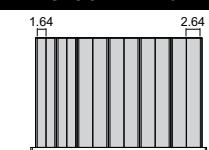
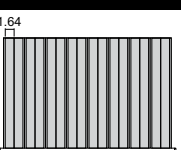
 <p>R_EE-TD10_ 10 GROOVE TRAYS</p>	 <p>R_EE-TW12_ 12 GROOVE TRAYS</p>	 <p>R_EE-TW16_ 16 GROOVE TRAYS</p>
---	---	---

### HANGING FILE BARS<sup>3</sup>

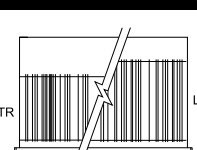
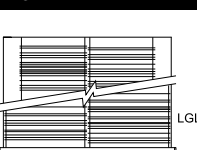
 <p>R_EE-KLR_ WIDTH</p>	 <p>R_EE-KFB_ DEPTH</p>
---	--

NOTES: <sup>1</sup> Two dividers included with each groove. <sup>2</sup> Available for 3"H and 4"H drawers. <sup>3</sup> Available for 12"H and 14"H drawers.

# PRECONFIGURED MODELS

## 36"W x 27"D DRAWERS – CABINETS / MULTI-DRAWER

### PARTITIONS AND DIVIDERS

<p>R__EG-A0203__ 6 COMPARTMENTS</p>	<p>R__EG-A0300__ 4 COMPARTMENTS</p>	<p>R__EG-A0308__ 12 COMPARTMENTS</p>	<p>R__EG-A0312__ 16 COMPARTMENTS</p>	<p>R__EG-A0415__ 20 COMPARTMENTS</p>
<p>R__EG-A0425__ 30 COMPARTMENTS</p>	<p>R__EG-A0512__ 18 COMPARTMENTS</p>	<p>R__EG-A0518__ 24 COMPARTMENTS</p>	<p>R__EG-A0524__ 30 COMPARTMENTS</p>	<p>R__EG-A0716__ 24 COMPARTMENTS</p>
<p>R__EG-A0724__ 32 COMPARTMENTS</p>	<p>R__EG-A0740__ 48 COMPARTMENTS</p>	<p>R__EG-B0200__ 3 COMPARTMENTS</p>	<p>R__EG-C0508__ 14 COMPARTMENTS</p>	<p>R__EG-D0309__ 13 COMPARTMENTS</p>

### PLASTIC BINS<sup>2</sup>

<p>R__EG-E032__ 32 BINS</p>	<p>R__EG-E048__ 48 BINS</p>	<p>R__EG-E064__ 64 BINS</p>
---------------------------------	---------------------------------	---------------------------------

### FOAM<sup>2</sup>

<p>R__EG-J01__ PROTECTIVE FOAM</p>	<p>R__EG-J02__ TOOL FOAM</p>	<p>Sold without cut-outs</p>
--	----------------------------------	------------------------------

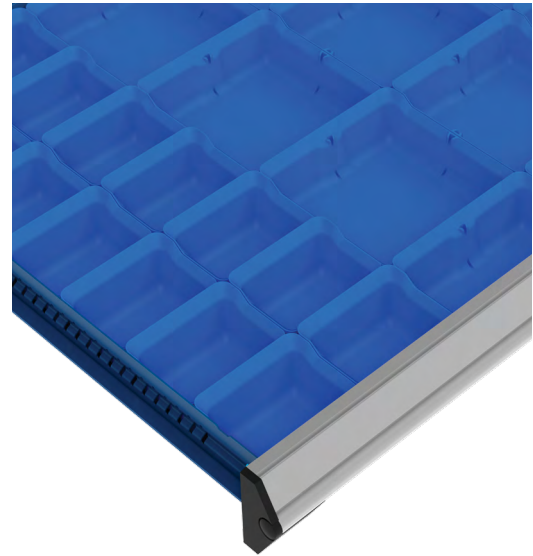

### GROOVE TRAYS<sup>1,2</sup>

<p>R__EG-TD12__ 12 GROOVE TRAYS</p>	<p>R__EG-TW12__ 12 GROOVE TRAYS</p>	<p>R__EG-TW16__ 16 GROOVE TRAYS</p>
---	---	---

### HANGING FILE BARS<sup>3</sup>

<p>R__EG-KLR__ WIDTH</p>	<p>R__EG-KFB__ DEPTH</p>
------------------------------	------------------------------

NOTES: <sup>1</sup> Two dividers included with each groove. <sup>2</sup> Available for 3"H and 4"H drawers. <sup>3</sup> Available for 12"H and 14"H drawers.

## 42"W x 18"D DRAWERS – SHELVING

### PARTITIONS AND DIVIDERS

<p>R_GC-A0203__ 6 COMPARTMENTS</p>	<p>R_GC-A0209__ 12 COMPARTMENTS</p>	<p>R_GC-A0304__ 8 COMPARTMENTS</p>	<p>R_GC-A0308__ 12 COMPARTMENTS</p>	<p>R_GC-A0405__ 10 COMPARTMENTS</p>
<p>R_GC-A0410__ 15 COMPARTMENTS</p>	<p>R_GC-A0415__ 20 COMPARTMENTS</p>	<p>R_GC-A0506__ 12 COMPARTMENTS</p>	<p>R_GC-A0512__ 18 COMPARTMENTS</p>	<p>R_GC-A0518__ 24 COMPARTMENTS</p>
<p>R_GC-A0708__ 16 COMPARTMENTS</p>	<p>R_GC-A0716__ 24 COMPARTMENTS</p>	<p>R_GC-A0724__ 32 COMPARTMENTS</p>	<p>R_GC-A0910__ 20 COMPARTMENTS</p>	<p>R_GC-A0930__ 40 COMPARTMENTS</p>

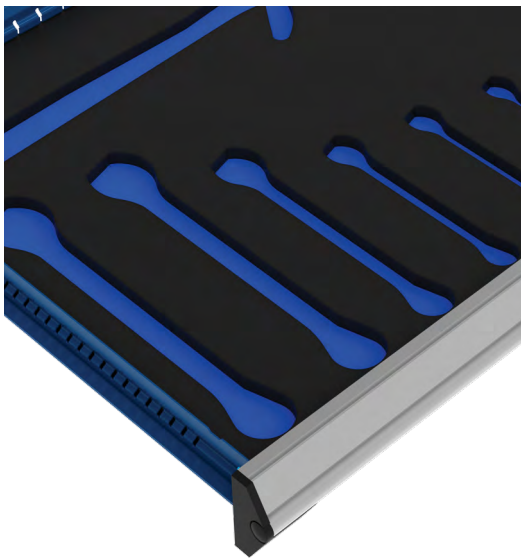

### PLASTIC BINS<sup>2</sup>

<p>R_GC-E025__ 25 BINS</p>	<p>R_GC-E035__ 35 BINS</p>	<p>R_GC-E045__ 45 BINS</p>
--------------------------------	--------------------------------	--------------------------------

### FOAM<sup>2</sup>

<p>R_GC-J01__ PROTECTIVE FOAM</p>	<p>R_GC-J02__ TOOL FOAM</p>	<p>Sold without cut-outs</p>
---------------------------------------	---------------------------------	------------------------------

### GROOVE TRAYS<sup>1,2</sup>

<p>R_GC-TD08__ 8 GROOVE TRAYS</p>	<p>R_GC-TW16__ 16 GROOVE TRAYS</p>	<p>R_GC-TW20__ 20 GROOVE TRAYS</p>
---------------------------------------	--	--

### HANGING FILE BARS<sup>3</sup>

<p>R_GC-KLR__ WIDTH</p>	<p>R_GC-KFB__ DEPTH</p>
-----------------------------	-----------------------------

NOTES: <sup>1</sup> Two dividers included with each groove. <sup>2</sup> Available for 3"H and 4"H drawers. <sup>3</sup> Available for 12"H and 14"H drawers.



# PRECONFIGURED MODELS

## 42"W x 24"D DRAWERS – SHELVING

### PARTITIONS AND DIVIDERS

<p>R_GE-A0203__ 6 COMPARTMENTS</p>	<p>R_GE-A0212__ 15 COMPARTMENTS</p>	<p>R_GE-A0304__ 8 COMPARTMENTS</p>	<p>R_GE-A0308__ 12 COMPARTMENTS</p>
<p>R_GE-A0316__ 20 COMPARTMENTS</p>	<p>R_GE-A0415__ 20 COMPARTMENTS</p>	<p>R_GE-A0420__ 25 COMPARTMENTS</p>	<p>R_GE-A0512__ 18 COMPARTMENTS</p>
<p>R_GE-A0524__ 30 COMPARTMENTS</p>	<p>R_GE-A0716__ 24 COMPARTMENTS</p>	<p>R_GE-A0732__ 40 COMPARTMENTS</p>	<p>R_GE-A0910__ 20 COMPARTMENTS</p>
<p>R_GE-A0920__ 30 COMPARTMENTS</p>	<p>R_GE-C0408__ 13 COMPARTMENTS</p>	<p>R_GE-D0517__ 23 COMPARTMENTS</p>	

### FOAM<sup>2</sup>

<p>R_GE-J01__ PROTECTIVE FOAM</p>	<p>R_GE-J02__ TOOL FOAM</p>
---------------------------------------	---------------------------------

**Sold without cut-outs**

### HANGING FILE BARS<sup>3</sup>

<p>R_GE-KLR__ WIDTH</p>
-----------------------------

### PLASTIC BINS<sup>2</sup>

<p>R_GE-E034__ 34 BINS</p>	<p>R_GE-E049__ 49 BINS</p>	<p>R_GE-E063__ 63 BINS</p>	<p>R_GE-KFB__ DEPTH</p>
--------------------------------	--------------------------------	--------------------------------	-----------------------------

### GROOVE TRAYS<sup>1,2</sup>

<p>R_GE-TD10__ 10 GROOVE TRAYS</p>	<p>R_GE-TW16__ 16 GROOVE TRAYS</p>	<p>R_GE-TW20__ 20 GROOVE TRAYS</p>
--	--	--

NOTES: <sup>1</sup>Two dividers included with each groove. <sup>2</sup> Available for 3"H and 4"H drawers. <sup>3</sup> Available for 12"H and 14"H drawers.

## 48"W x 18"D DRAWERS – SHELVING

### PARTITIONS AND DIVIDERS

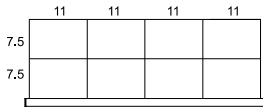

R\_HC-A0304\_\_  
8 COMPARTMENTS

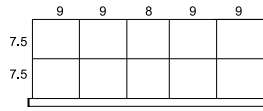

R\_HC-A0405\_\_  
10 COMPARTMENTS

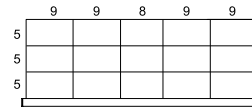

R\_HC-A0410\_\_  
15 COMPARTMENTS

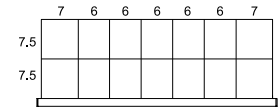

R\_HC-A0607\_\_  
14 COMPARTMENTS

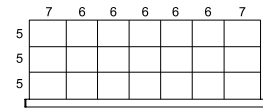

R\_HC-A0614\_\_  
21 COMPARTMENTS

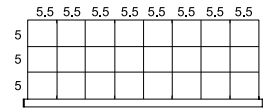

R\_HC-A0716\_\_  
24 COMPARTMENTS

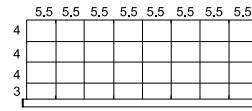

R\_HC-A0724\_\_  
32 COMPARTMENTS

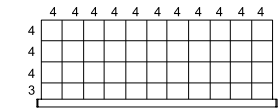

R\_HC-A1033\_\_  
44 COMPARTMENTS

### PLASTIC BINS<sup>2</sup>

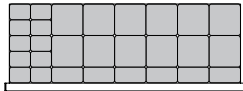

R\_HC-E028\_\_  
28 BINS

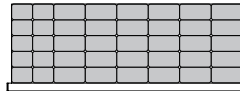

R\_HC-E040\_\_  
40 BINS

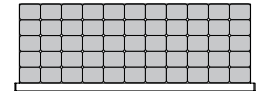

R\_HC-E055\_\_  
55 BINS

### FOAM<sup>2</sup>



R\_HC-J01\_\_  
PROTECTIVE FOAM

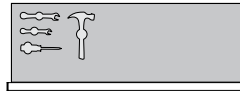

R\_HC-J02\_\_  
TOOL FOAM



### GROOVE TRAYS<sup>1,2</sup>

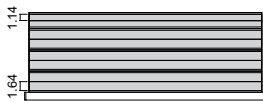

R\_HC-TD08\_\_  
8 GROOVE TRAYS

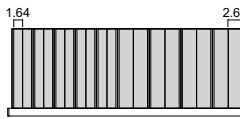

R\_HC-TW18\_\_  
18 GROOVE TRAYS

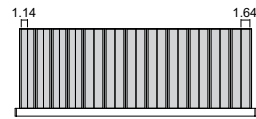

R\_HC-TW24\_\_  
24 GROOVE TRAYS

### HANGING FILE BARS<sup>3</sup>

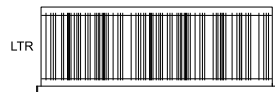

R\_HC-KLR\_\_  
WIDTH

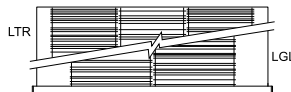

R\_HC-KFB\_\_  
DEPTH



NOTES: <sup>1</sup> Two dividers included with each groove. <sup>2</sup> Available for 3"H and 4"H drawers. <sup>3</sup> Available for 12"H and 14"H drawers.

# PRECONFIGURED MODELS

## 48"W x 24"D DRAWERS – CABINETS / MULTI-DRAWER / SHELVING

### PARTITIONS AND DIVIDERS

<p>R__HE-A0304__ 8 COMPARTMENTS</p>	<p>R__HE-A0308__ 12 COMPARTMENTS</p>	<p>R__HE-A0410__ 15 COMPARTMENTS</p>	<p>R__HE-A0415__ 20 COMPARTMENTS</p>
<p>R__HE-A0420__ 25 COMPARTMENTS</p>	<p>R__HE-C0505__ 11 COMPARTMENTS</p>	<p>R__HE-A0512__ 18 COMPARTMENTS</p>	<p>R__HE-A0518__ 24 COMPARTMENTS</p>
<p>R__HE-A0614__ 21 COMPARTMENTS</p>	<p>R__HE-D0618__ 25 COMPARTMENTS</p>	<p>R__HE-A0621__ 28 COMPARTMENTS</p>	<p>R__HE-A0628__ 35 COMPARTMENTS</p>
<p>R__HE-A0724__ 32 COMPARTMENTS</p>	<p>R__HE-A0732__ 40 COMPARTMENTS</p>	<p>R__HE-A0836__ 45 COMPARTMENTS</p>	<p>R__HE-A1044__ 55 COMPARTMENTS</p>

### PLASTIC BINS<sup>2</sup>

<p>R__HE-E038__ 38 BINS</p>	<p>R__HE-E056__ 56 BINS</p>	<p>R__HE-E077__ 77 BINS</p>
---------------------------------	---------------------------------	---------------------------------

### HANGING FILE BARS<sup>3</sup>

<p>R__HE-KLR__ WIDTH</p>
------------------------------

### GROOVE TRAYS<sup>1,2</sup>

<p>R__HE-TD10__ 10 GROOVE TRAYS</p>	<p>R__HE-TW18__ 18 GROOVE TRAYS</p>	<p>R__HE-TW24__ 24 GROOVE TRAYS</p>
---	---	---

<p>R__HE-KFB__ DEPTH</p>
------------------------------

### FOAM<sup>2</sup>

<p>R__HE-J01__ PROTECTIVE FOAM</p>	<p>R__HE-J02__ TOOL FOAM</p>	<p>R__HE-J03__ COLLET FOAM</p>
--	----------------------------------	------------------------------------

Sold without cut-outs

NOTES: <sup>1</sup> Two dividers included with each groove. <sup>2</sup> Available for 3"H and 4"H drawers. <sup>3</sup> Available for 12"H and 14"H drawers.

## 48"W x 27"D DRAWERS – CABINETS / MULTI-DRAWER

### PARTITIONS AND DIVIDERS

<p>R_HG-A0304__ 8 COMPARTMENTS</p>	<p>R_HG-A0308__ 12 COMPARTMENTS</p>	<p>R_HG-A0312__ 16 COMPARTMENTS</p>	<p>R_HG-A0410__ 15 COMPARTMENTS</p>
<p>R_HG-A0415__ 20 COMPARTMENTS</p>	<p>R_HG-A0518__ 24 COMPARTMENTS</p>	<p>R_HG-A0524__ 30 COMPARTMENTS</p>	<p>R_HG-A0607__ 14 COMPARTMENTS</p>
<p>R_HG-A0621__ 28 COMPARTMENTS</p>	<p>R_HG-A0716__ 24 COMPARTMENTS</p>	<p>R_HG-A0724__ 32 COMPARTMENTS</p>	<p>R_HG-A0818__ 27 COMPARTMENTS</p>
<p>R_HG-A0836__ 45 COMPARTMENTS</p>	<p>R_HG-A1033__ 44 COMPARTMENTS</p>	<p>R_HG-D0615__ 22 COMPARTMENTS</p>	

### PLASTIC BINS<sup>2</sup>

<p>R_HG-E040__ 40 BINS</p>	<p>R_HG-E064__ 64 BINS</p>	<p>R_HG-E088__ 88 BINS</p>
--------------------------------	--------------------------------	--------------------------------

### HANGING FILE BARS<sup>3</sup>

<p>R_HG-KLR__ WIDTH</p>
-----------------------------

### GROOVE TRAYS<sup>1,2</sup>

<p>R_HG-TD12__ 12 GROOVE TRAYS</p>	<p>R_HG-TW18__ 18 GROOVE TRAYS</p>	<p>R_HG-TW24__ 24 GROOVE TRAYS</p>
--	--	--

<p>R_HG-KFB__ DEPTH</p>
-----------------------------

### FOAM<sup>2</sup>

<p>R_HG-J01__ PROTECTIVE FOAM</p>	<p>R_HG-J02__ TOOL FOAM</p>
---------------------------------------	---------------------------------

Sold without cut-outs

NOTES: <sup>1</sup> Two dividers included with each groove. <sup>2</sup> Available for 3"H and 4"H drawers. <sup>3</sup> Available for 12"H and 14"H drawers.

# PRECONFIGURED MODELS

## 54"W x 24"D DRAWERS – CABINETS / MULTI-DRAWER

### PARTITIONS AND DIVIDERS

<p>R_JE-B0200__ 3 COMPARTMENTS</p>	<p>R_JE-A0304__ 8 COMPARTMENTS</p>	<p>R_JE-A0405__ 10 COMPARTMENTS</p>	<p>R_JE-A0410__ 15 COMPARTMENTS</p>
<p>R_JE-A0512__ 18 COMPARTMENTS</p>	<p>R_JE-A0716__ 24 COMPARTMENTS</p>	<p>R_JE-A0708__ 16 COMPARTMENTS</p>	<p>R_JE-A0930__ 40 COMPARTMENTS</p>
<p>R_JE-A1124__ 36 COMPARTMENTS</p>	<p>R_JE-A1596__ 112 COMPARTMENTS</p>	<p>R_JE-C0202__ 5 COMPARTMENTS</p>	<p>R_JE-D0824__ 33 COMPARTMENTS</p>

### PLASTIC BINS<sup>2</sup>

<p>R_JE-E042__ 42 BINS</p>	<p>R_JE-E063__ 63 BINS</p>	<p>R_JE-E084__ 84 BINS</p>
--------------------------------	--------------------------------	--------------------------------

### FOAM<sup>2</sup>

<p>R_JE-J01__ PROTECTIVE FOAM</p>	<p>R_JE-J02__ TOOL FOAM</p>	<p>Sold without cut-outs</p>
---------------------------------------	---------------------------------	------------------------------

### GROOVE TRAYS<sup>1,2</sup>

<p>R_JE-TD10__ 10 GROOVE TRAYS</p>	<p>R_JE-TW20__ 20 GROOVE TRAYS</p>	<p>R_JE-TW22__ 22 GROOVE TRAYS</p>
--	--	--

### HANGING FILE BARS<sup>3</sup>

<p>R_JE-KFB__ DEPTH</p>
-----------------------------

NOTES: <sup>1</sup> Two dividers included with each groove. <sup>2</sup> Available for 3"H and 4"H drawers. <sup>3</sup> Available for 12"H and 14"H drawers.

## 54"W x 27"D DRAWERS – CABINETS / MULTI-DRAWER

### PARTITIONS AND DIVIDERS

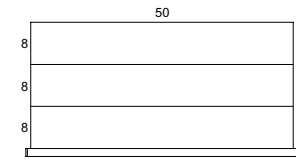

R\_JG-B0200\_\_  
3 COMPARTMENTS

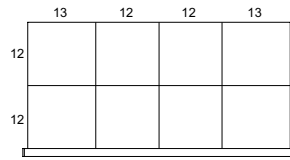

R\_JG-A0304\_\_  
8 COMPARTMENTS

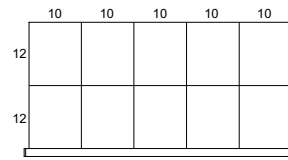

R\_JG-A0405\_\_  
10 COMPARTMENTS

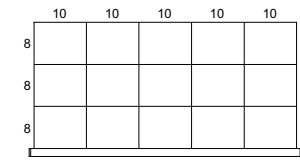

R\_JG-A0410\_\_  
15 COMPARTMENTS

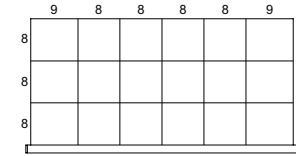

R\_JG-A0512\_\_  
18 COMPARTMENTS

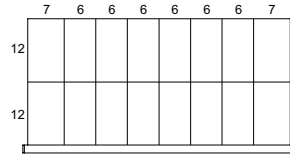

R\_JG-A0708\_\_  
16 COMPARTMENTS

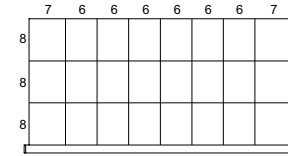

R\_JG-A0716\_\_  
24 COMPARTMENTS

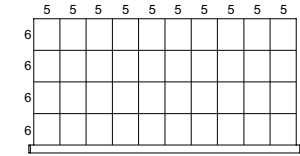

R\_JG-A0930\_\_  
40 COMPARTMENTS

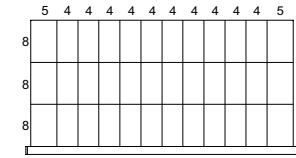

R\_JG-A1124\_\_  
36 COMPARTMENTS

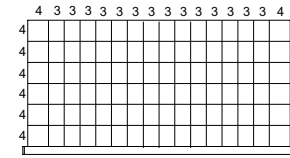

R\_JG-A1580\_\_  
96 COMPARTMENTS

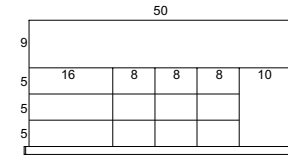

R\_JG-C0508\_\_  
14 COMPARTMENTS

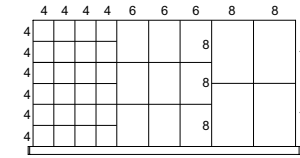

R\_JG-D0828\_\_  
37 COMPARTMENTS

### PLASTIC BINS<sup>2</sup>

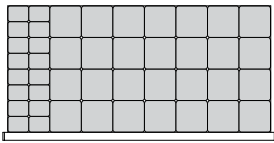

R\_JG-E044\_\_  
44 BINS

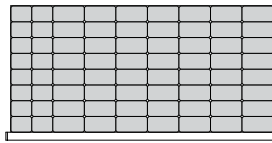

R\_JG-E072\_\_  
72 BINS

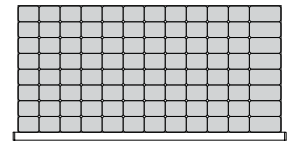

R\_JG-E096\_\_  
96 BINS

### FOAM<sup>2</sup>



R\_JG-J01\_\_  
PROTECTIVE FOAM

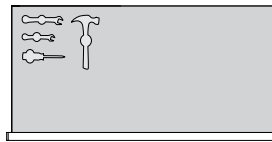

R\_JG-J02\_\_  
TOOL FOAM



### GROOVE TRAYS<sup>1,2</sup>



R\_JG-TD12\_\_  
12 GROOVE TRAYS

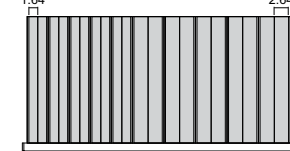

R\_JG-TW20\_\_  
20 GROOVE TRAYS

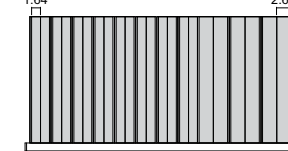

R\_JG-TW22\_\_  
22 GROOVE TRAYS

### HANGING FILE BARS<sup>3</sup>

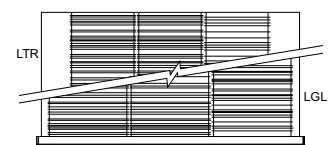

R\_JG-KFB\_\_  
DEPTH

NOTES: <sup>1</sup> Two dividers included with each groove. <sup>2</sup> Available for 3"H and 4"H drawers. <sup>3</sup> Available for 12"H and 14"H drawers.

# PRECONFIGURED MODELS

## 60"W x 24"D DRAWERS – CABINETS / MULTI-DRAWER

### PARTITIONS AND DIVIDERS

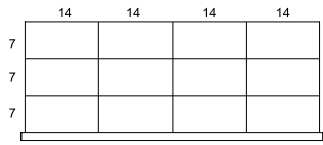

R\_\_KE-A0308\_\_  
12 COMPARTMENTS

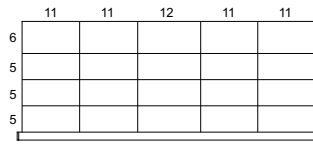

R\_\_KE-A0415\_\_  
20 COMPARTMENTS

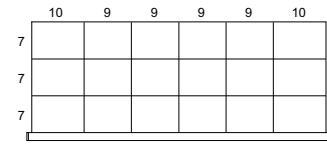

R\_\_KE-A0512\_\_  
18 COMPARTMENTS

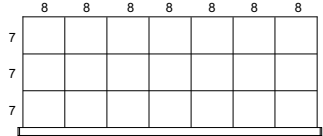

R\_\_KE-A0614\_\_  
21 COMPARTMENTS

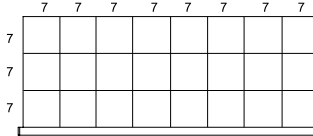

R\_\_KE-A0716\_\_  
24 COMPARTMENTS

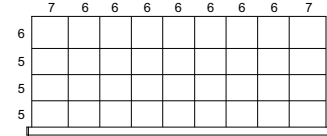

R\_\_KE-A0827\_\_  
36 COMPARTMENTS

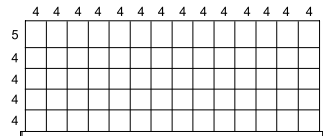

R\_\_KE-A1356\_\_  
70 COMPARTMENTS

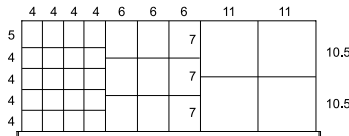

R\_\_KE-D0824\_\_  
33 COMPARTMENTS

### HANGING FILE BARS<sup>3</sup>

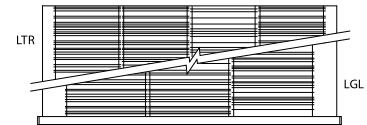

R\_\_KE-KFB\_\_  
DEPTH

### PLASTIC BINS<sup>2</sup>

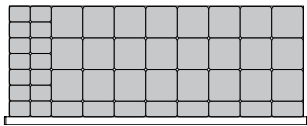

R\_\_KE-E046\_\_  
46 BINS

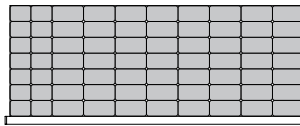

R\_\_KE-E070\_\_  
70 BINS

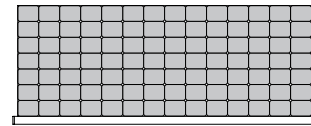

R\_\_KE-E098\_\_  
98 BINS

### FOAM<sup>2</sup>



R\_\_KE-J01\_\_  
PROTECTIVE FOAM



R\_\_KE-J02\_\_  
TOOL FOAM



### GROOVE TRAYS<sup>1,2</sup>



R\_\_KE-TD10\_\_  
10 GROOVE TRAYS

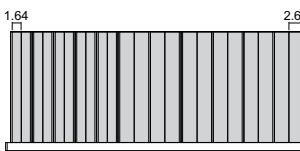

R\_\_KE-TW22\_\_  
22 GROOVE TRAYS

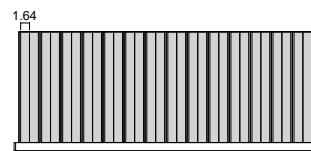

R\_\_KE-TW28\_\_  
28 GROOVE TRAYS

NOTES: <sup>1</sup> Two dividers included with each groove. <sup>2</sup> Available for 3"H and 4"H drawers. <sup>3</sup> Available for 12"H and 14"H drawers.

## 60"W x 27"D DRAWERS – CABINETS / MULTI-DRAWER

### PARTITIONS AND DIVIDERS

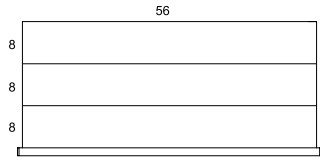

R\_\_KG-B0200\_\_

3 COMPARTMENTS

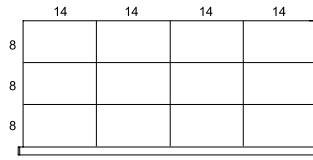

R\_\_KG-A0308\_\_

12 COMPARTMENTS

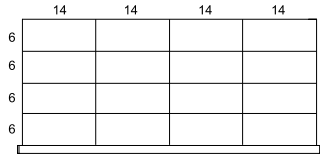

R\_\_KG-A0312\_\_

16 COMPARTMENTS

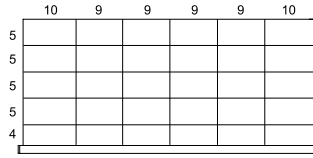

R\_\_KG-A0524\_\_

30 COMPARTMENTS

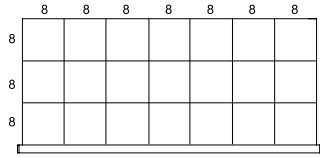

R\_\_KG-A0614\_\_

21 COMPARTMENTS

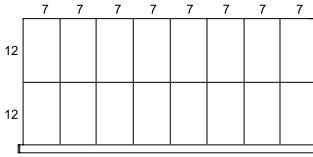

R\_\_KG-A0708\_\_

16 COMPARTMENTS

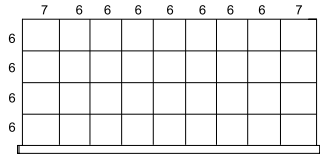

R\_\_KG-A0827\_\_

36 COMPARTMENTS

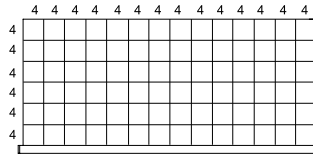

R\_\_KG-A1370\_\_

84 COMPARTMENTS

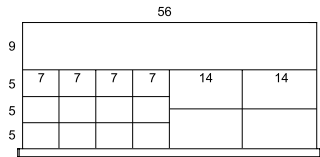

R\_\_KG-C0610\_\_

17 COMPARTMENTS

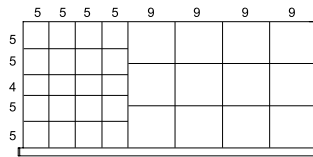

R\_\_KG-D0724\_\_

32 COMPARTMENTS

### PLASTIC BINS<sup>2</sup>

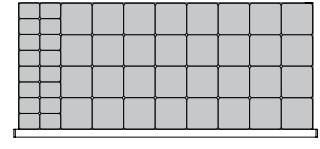

R\_\_KG-E048\_\_

48 BINS

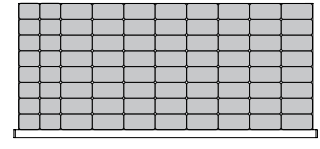

R\_\_KG-E080\_\_

80 BINS

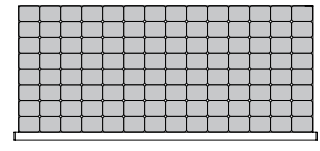

R\_\_KG-E112\_\_

112 BINS

### HANGING FILE BARS<sup>3</sup>



R\_\_KG-KFB\_\_

DEPTH

### FOAM<sup>2</sup>



R\_\_KG-J01\_\_

PROTECTIVE FOAM

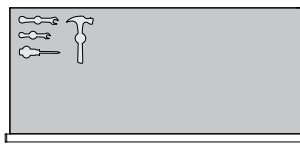

R\_\_KG-J02\_\_

TOOL FOAM



### GROOVE TRAYS<sup>1,2</sup>

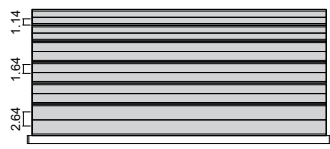

R\_\_KG-TD12\_\_

12 GROOVE TRAYS

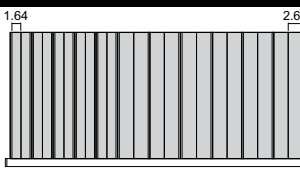

R\_\_KG-TW22\_\_

22 GROOVE TRAYS



R\_\_KG-TW28\_\_

28 GROOVE TRAYS

NOTES: <sup>1</sup> Two dividers included with each groove. <sup>2</sup> Available for 3"H and 4"H drawers. <sup>3</sup> Available for 12"H and 14"H drawers.



## SUBDIVIDING ACCESSORIES

Our tool-free "clip-in" subdividing system keeps the dividers firmly in place and reduces noise caused by vibrations.

### FRONT TO BACK PARTITION

RG00

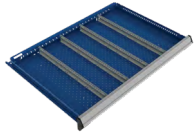

- Divides the drawer along its depth
- Clip-in system locks dividers in place
- Adjustable in 1" increments (c/c)
- Color: Light Gray (#071)
- Compatible with the following accessories: plastic bins (RG20/RG21), groove trays (RG35), hanging file bars (RG30/RG31) and PVC drawer liners (RG40)

NOMINAL CABINET DEPTH (ACTUAL)	DRAWER FACE HEIGHT (ACTUAL PARTITION HEIGHT)						
	3" (1 $\frac{1}{4}$ "H)	4" (2 $\frac{1}{4}$ "H)	5" (3 $\frac{1}{4}$ "H)	6" AND 7" (4 $\frac{1}{4}$ "H)	8" AND 9" (6 $\frac{1}{4}$ "H)	10" (8 $\frac{1}{4}$ "H)	12" AND 14" (10 $\frac{1}{4}$ "H)
18" (15")	RG00-1803	RG00-1804	RG00-1805	RG00-1806	RG00-1808	RG00-1810	RG00-1812
21" (18")	RG00-2103	RG00-2104	RG00-2105	RG00-2106	RG00-2108	RG00-2110	RG00-2112
24" (21")	RG00-2403	RG00-2404	RG00-2405	RG00-2406	RG00-2408	RG00-2410	RG00-2412
27" (24")	RG00-2703	RG00-2704	RG00-2705	RG00-2706	RG00-2708	RG00-2710	RG00-2712

### LEFT TO RIGHT PARTITION

RG01

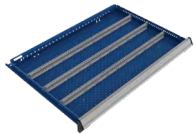

- Divides the drawer across its width
- Clip-in system locks dividers in place
- Adjustable in  $\frac{1}{2}$ " increments (c/c)
- Color: Light Gray (#071)
- Compatible with the following accessories: plastic bins (RG20/RG21), groove trays (RG35), hanging file bars (RG30/RG31) and PVC drawer liners (RG40)

NOMINAL DRAWER WIDTH (ACTUAL)	DRAWER FACE HEIGHT (ACTUAL PARTITION HEIGHT)						
	3" (1 $\frac{1}{4}$ "H)	4" (2 $\frac{1}{4}$ "H)	5" (3 $\frac{1}{4}$ "H)	6" AND 7" (4 $\frac{1}{4}$ "H)	8" AND 9" (6 $\frac{1}{4}$ "H)	10" (8 $\frac{1}{4}$ "H)	12" AND 14" (10 $\frac{1}{4}$ "H)
18" (14")	RG01-1803	RG01-1804	RG01-1805	RG01-1806	RG01-1808	RG01-1810	RG01-1812
24" (20")	RG01-2403	RG01-2404	RG01-2405	RG01-2406	RG01-2408	RG01-2410	RG01-2412
30" (26")	RG01-3003	RG01-3004	RG01-3005	RG01-3006	RG01-3008	RG01-3010	RG01-3012
36" (32")	RG01-3603	RG01-3604	RG01-3605	RG01-3606	RG01-3608	RG01-3610	RG01-3612
42" (38")	RG01-4203	RG01-4204	RG01-4205	RG01-4206	RG01-4208	RG01-4210	RG01-4212
48" (44")	RG01-4803	RG01-4804	RG01-4805	RG01-4806	RG01-4808	RG01-4810	RG01-4812
54" (50")	RG01-5403	RG01-5404	RG01-5405	RG01-5406	RG01-5408	RG01-5410	RG01-5412
60" (56")	RG01-6003	RG01-6004	RG01-6005	RG01-6006	RG01-6008	RG01-6010	RG01-6012

### DRAWER DIVIDER

RG10

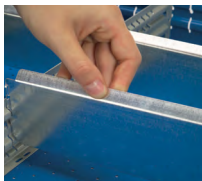

- Dividers clip in place
- 45° angled edge for easy identification of compartment contents
- Galvanized steel
- Adjustable in  $\frac{1}{2}$ " increments (c/c)

ACTUAL DIVIDER WIDTH	DRAWER FACE HEIGHT (ACTUAL DIVIDER HEIGHT)						
	3" (1 $\frac{1}{4}$ "H)	4" (2 $\frac{1}{4}$ "H)	5" (3 $\frac{1}{4}$ "H)	6" AND 7" (4 $\frac{1}{4}$ "H)	8" AND 9" (6 $\frac{1}{4}$ "H)	10" (8 $\frac{1}{4}$ "H)	12" AND 14" (10 $\frac{1}{4}$ "H)
3"	RG10-03003	RG10-03004	RG10-03005	RG10-03006	-	-	-
*3.5"	RG10-03503	RG10-03504	RG10-03505	RG10-03506	-	-	-
4"	RG10-04003	RG10-04004	RG10-04005	RG10-04006	-	-	-
5"	RG10-05003	RG10-05004	RG10-05005	RG10-05006	RG10-05008	RG10-05010	-
*5.5"	RG10-05503	RG10-05504	RG10-05505	RG10-05506	RG10-05508	RG10-05510	-
6"	RG10-06003	RG10-06004	RG10-06005	RG10-06006	RG10-06008	RG10-06010	RG10-06012
*6.5"	RG10-06503	RG10-06504	RG10-06505	RG10-06506	RG10-06508	RG10-06510	RG10-06512
7"	RG10-07003	RG10-07004	RG10-07005	RG10-07006	RG10-07008	RG10-07010	RG10-07012
8"	RG10-08003	RG10-08004	RG10-08005	RG10-08006	RG10-08008	RG10-08010	RG10-08012
9"	RG10-09003	RG10-09004	RG10-09005	RG10-09006	RG10-09008	RG10-09010	RG10-09012
*9.5"	RG10-09503	RG10-09504	RG10-09505	RG10-09506	RG10-09508	RG10-09510	RG10-09512
10"	RG10-10003	RG10-10004	RG10-10005	RG10-10006	RG10-10008	RG10-10010	RG10-10012
11"	RG10-11003	RG10-11004	RG10-11005	RG10-11006	RG10-11008	RG10-11010	RG10-11012
12"	RG10-12003	RG10-12004	RG10-12005	RG10-12006	RG10-12008	RG10-12010	RG10-12012
13"	RG10-13003	RG10-13004	RG10-13005	RG10-13006	RG10-13008	RG10-13010	RG10-13012
14"	RG10-14003	RG10-14004	RG10-14005	RG10-14006	RG10-14008	RG10-14010	RG10-14012
16"	RG10-16003	RG10-16004	RG10-16005	RG10-16006	RG10-16008	RG10-16010	RG10-16012

NOTE: \*These dimensions are not compatible with all drawer widths.

## LABEL HOLDERS AND HANDLE PROTECTOR

### 1" H LABEL HOLDER

RG51

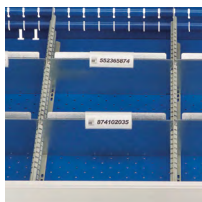

- Made of transparent, matte plastic that eliminates glare and makes labels easy to read
- Once clipped in place, the label holder is securely attached and does not come off when removing items
- Includes a flap to protect the label from damage
- Two standard widths available: 2" for all applications, and 2¾" for 3"W accessories and wider
- Can be attached to drawer partitions and dividers

PRODUCT NO.	W×H
RG51-200	2" × 1"
RG51-275	2¾" × 1"

NOTE: Cardboard labels are not included with label holders but are available in packs of 200.

### 1" H LABEL HOLDER WITH ADHESIVE STRIP FOR PLASTIC BINS

RG52



- Made of transparent, matte plastic that eliminates glare and makes labels easy to read
- Includes an adhesive strip for attaching to RG20 plastic bins. Also attaches to the back of the drawer for identification of the last compartment
- Includes a flap to protect the label from damage

PRODUCT NO.	W×H
RG52-200	2" × 1"

NOTE: Cardboard labels are not included with label holders but are available in packs of 200.

### CARDBOARD LABELS (PACKS OF 200)

RG53

PRODUCT NO.	W×H
RG53-275875	2¾" × ¾"

### 1 ¾" H LABEL HOLDER

RG54



- Made of transparent, matte plastic that eliminates glare and makes labels easy to read
- Once clipped in place, the label holder is securely attached and does not come off when removing items
- Includes a flap to protect the label from damage
- Two standard widths available: 2" and 4"
- Attaches to drawer dividers

PRODUCT NO.	W×H
RG54-200	2" × 1¾"
RG54-400	4" × 1¾"

NOTE: Cardboard labels are not included with label holders.

### 1 ¾" H LABEL HOLDER WITH ADHESIVE STRIP

RG55



- Made of transparent, matte plastic that eliminates glare and makes labels easy to read
- Includes an adhesive strip that attaches to the back of the drawer for identification of the last compartment
- Includes a flap to protect the label from damage
- Two standard widths available: 2" and 4"

PRODUCT NO.	W×H
RG55-200	2" × 1¾"
RG55-400	4" × 1¾"

NOTE: Cardboard labels are not included with label holders.

### HANDLE PROTECTOR

RF70

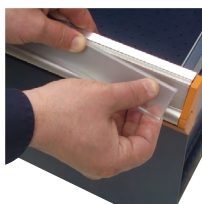

- Clips onto the handle of the drawer or roll-out shelf
- Made of transparent, matte plastic that eliminates glare and makes labels easy to read
- Protects identification labels from dust, grease and dirt
- Easy to remove

PRODUCT NO.	WIDTH
RF70-18	18"
RF70-24	24"
RF70-30	30"
RF70-36	36"
RF70-42	42"
RF70-48	48"
RF70-54	54"
RF70-60	60"

### HANDLE LABELS

RF71



- Labels to be attached to handles under the handle protector (RF70)
- 22 labels per page (10 pages)
- Print your own labels. A template is available on [www.rousseau-metal.com](http://www.rousseau-metal.com) under Information Center > Documents

PRODUCT NO.	W×H
RF71-425100	4½" × 1"

# ACCESSORIES

## DRAWER ACCESSORIES

### PVC DRAWER LINER

RG40

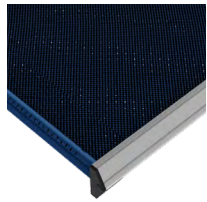

- Protects items stored in the drawer
- Non-slip material
- Can be installed under partitions and dividers
- Thickness: 3/32"

PRODUCT NO.	FOR DRAWER
RG40-1821-01	18"W x 21"D
RG40-1824-01	18"W x 24"D
RG40-1827-01	18"W x 27"D
RG40-2421-01	24"W x 21"D
RG40-2424-01	24"W x 24"D
RG40-2427-01	24"W x 27"D
RG40-3018-01	30"W x 18"D
RG40-3021-01	30"W x 21"D
RG40-3024-01	30"W x 24"D
RG40-3027-01	30"W x 27"D
RG40-3618-01	36"W x 18"D
RG40-3624-01	36"W x 24"D
RG40-3627-01	36"W x 27"D

NOTE: Do not use with ESD cabinets

### PROTECTIVE FOAM

RG41

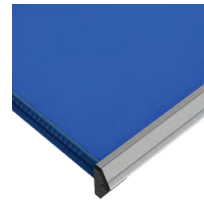

- Protects items stored in the drawer
- One piece of 1/4"-thick blue foam

PRODUCT NO.	FOR DRAWER
RG41-1821-01	18"W x 21"D
RG41-1824-01	18"W x 24"D
RG41-1827-01	18"W x 27"D
RG41-2421-01	24"W x 21"D
RG41-2424-01	24"W x 24"D
RG41-2427-01	24"W x 27"D
RG41-3018-01	30"W x 18"D
RG41-3021-01	30"W x 21"D
RG41-3024-01	30"W x 24"D
RG41-3027-01	30"W x 27"D
RG41-3618-01	36"W x 18"D
RG41-3624-01	36"W x 24"D
RG41-3627-01	36"W x 27"D

NOTE: Partitions and dividers cannot be installed in the same drawer as this foam.

### TOOL FOAM

RG42

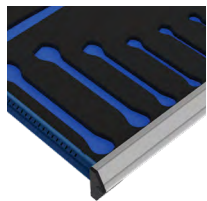

- Oil resistant and non-absorbent
- One piece of 1/4"-thick blue foam
- One piece of 1/2"-thick self-adhesive black foam
- Sold without cut-outs. Can be cut with a utility knife

PRODUCT NO.	FOR DRAWER
RG42-1821-01	18"W x 21"D
RG42-1824-01	18"W x 24"D
RG42-1827-01	18"W x 27"D
RG42-2421-01	24"W x 21"D
RG42-2424-01	24"W x 24"D
RG42-2427-01	24"W x 27"D
RG42-3018-01	30"W x 18"D
RG42-3021-01	30"W x 21"D
RG42-3024-01	30"W x 24"D
RG42-3027-01	30"W x 27"D
RG42-3618-01	36"W x 18"D
RG42-3624-01	36"W x 24"D
RG42-3627-01	36"W x 27"D

PRODUCT NO.	FOR DRAWER
RG42-4218-01	42"W x 18"D
RG42-4224-01	42"W x 24"D
RG42-4818-01	48"W x 18"D
RG42-4824-01	48"W x 24"D
RG42-4827-01	48"W x 27"D
RG42-5424-01	54"W x 24"D
RG42-5427-01	54"W x 27"D
RG42-6024-01	60"W x 24"D
RG42-6027-01	60"W x 27"D



### COLLET FOAM

RG43

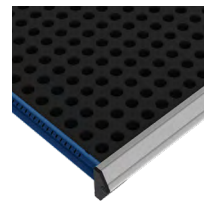

- Oil resistant and non-absorbent
- One piece of 1"-thick black foam
- Sold without cut-outs. Can be cut with a hole punch

PRODUCT NO.	FOR DRAWER
RG43-1821-01	18"W x 21"D
RG43-1824-01	18"W x 24"D
RG43-1827-01	18"W x 27"D
RG43-2421-01	24"W x 21"D
RG43-2424-01	24"W x 24"D
RG43-2427-01	24"W x 27"D
RG43-3018-01	30"W x 18"D
RG43-3021-01	30"W x 21"D
RG43-3024-01	30"W x 24"D
RG43-3027-01	30"W x 27"D
RG43-3618-01	36"W x 18"D
RG43-3624-01	36"W x 24"D

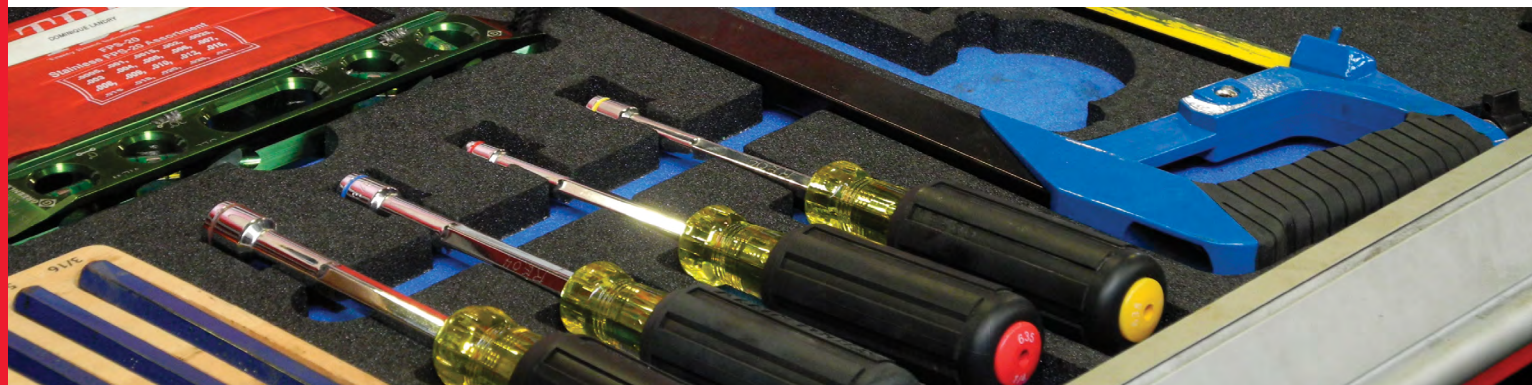



RG20

## PLASTIC BIN

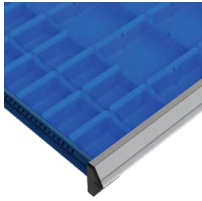

- For easier storing, moving and managing of small parts Lightweight and durable
- For 3"H and 4"H drawers
- 45° angled rim for easy identification of bin contents and removal of bins



- Compatible with the following accessories: partitions, dividers and groove trays
- 6" plastic bins can be subdivided

DIMENSIONS			PRODUCT NO.		
W	D	H	BIN	PARTITION	DIVIDER
3"	3"	2"	RG20-030302	-	-
4"	3"	2"	RG20-040302	-	-
6"	3"	2"	RG20-060302	RG22-0302	-
6"	6"	2"	RG20-060602	RG22-0602	RG24-0602
3"	3"	3"	RG20-030303	-	-
4"	3"	3"	RG20-040303	-	-
6"	3"	3"	RG20-060303	RG22-0303	-
6"	6"	3"	RG20-060603	RG22-0603	RG24-0603

NOTE: 2"H bins = 1½" actual height  
3"H bins = 2½" actual height



RG21

## CONDUCTIVE PLASTIC BIN



- Dissipates electrical charges that can damage electronic components
- For easier storing, moving and managing of small parts
- Lightweight and durable
- For 3"H and 4"H drawers



- 45° angled rim for easy identification of bin contents and removal of bins
- Color: black
- 6" plastic bins can be subdivided

DIMENSIONS			PRODUCT NO.		
W	D	H	BIN	PARTITION	DIVIDER
3"	3"	2"	RG21-030302	-	-
4"	3"	2"	RG21-040302	-	-
6"	3"	2"	RG21-060302	RG23-0302	-
6"	6"	2"	RG21-060602	RG23-0602	RG25-0602
3"	3"	3"	RG21-030303	-	-
4"	3"	3"	RG21-040303	-	-
6"	3"	3"	RG21-060303	RG23-0303	-
6"	6"	3"	RG21-060603	RG23-0603	RG25-0603

NOTE: 2"H bins = 1½" actual height  
3"H bins = 2½" actual height

## GROOVE TRAYS

RG35 / RG36

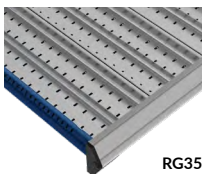

RG35



RG36

- For storing and protecting long objects such as drill bits, borers, sockets, lathe parts, files, tools, etc.
- Made of durable aluminum
- Vertical partitions for more storage space
- Wide compartment bottoms for easy cleaning
- Gray plastic divider with ¾" angled labeling area (to be ordered separately)
- For 3"H and 4"H drawers
- Compatible with the following accessories: partitions, dividers and plastic bins
- To order: Complete the product number with the depth required: 18", 21", 24", 27", or the width required 18", 24", 30", 36", 42", 48", 54", 60"

PRODUCT NO.		DIVIDER NO.
FRONT TO BACK	LEFT TO RIGHT	
RG35-03DD	RG36-03WW	RG39-03
RG35-04DD	RG36-04WW	RG39-04
RG35-06DD	RG36-06WW	RG39-06



RG39

NOTE: For drawer interior measurements, see pages 220-222

## HANGING FILE BARS

RG30 / RG31

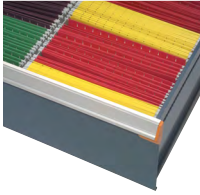

- For storing hanging files
- Fits both letter and legal sizes depending on the drawer dimensions
- For 12"H and 14"H drawers
- Compatible with partitions and dividers, see page 242

FRONT TO BACK BARS		LEFT TO RIGHT BARS	
PRODUCT NO.	NOMINAL DEPTH (ACTUAL)	PRODUCT NO.	NOMINAL WIDTH (ACTUAL)
RG30-18	18" (15")	RG31-18	18" (14")
RG30-21	21" (18")	RG31-24	24" (20")
RG30-24	24" (21")	RG31-30	30" (26")
RG30-27	27" (24")	RG31-36	36" (32")
		RG31-42	42" (38")
		RG31-48	48" (44")

## WASTE & RECYCLING DRAWER



- Used for sorting waste and items for recycling
- Includes a labeled drawer handle to facilitate sorting
- Drawer heights available: 17" and 26"
- The 17"H drawer includes two 14 $\frac{3}{8}$ "W x 10 $\frac{3}{4}$ "D x 15"H containers: a black container for waste and a blue container for recycling
- The 26"H drawer includes two 15 $\frac{3}{4}$ "W x 11"D x 20"H containers: a black container for waste and a blue container for recycling
- The drawer includes a divider which secures the containers and also allows items to be stored behind
- To add a locking or security mechanism, complete the product number with the locking mechanism product number required, e.g., R51CG-X1701A to add an integrated lock-in mechanism

PRODUCT NO.	W x D x H
R51CG-X1701	24" x 27" x 17"
R51CG-X2601	24" x 27" x 26"
R51DG-X1701	30" x 27" x 17"
R51DG-X2601	30" x 27" x 26"



R5XLG-3004



## LOCKING AND SECURITY MECHANISMS

### INTEGRATED LOCK-IN MECHANISM

A



- Integrated lock-in mechanism
- Automatically activated when lifting the handle up
- The drawer or roll-out shelf can be opened with one hand only
- Closes with a simple push
- Stops drawer or roll-out shelf from opening on their own
- Easy to retrofit
- To order: Add A to the product number for the drawer, preconfigured compartment layout or roll-out shelf, e.g., RF32-362406A
- For replacement parts or to retrofit this mechanism, order an RY08-WWA

PRODUCT NO. \_\_\_\_\_

A

### ECONO LOCK-IN MECHANISM

B



- Activated with the right hand by sliding the mechanism with thumb
- The drawer or roll-out shelf closes without having to reactivate the slide mechanism
- Stops drawer or roll-out shelf from opening on their own
- To order: Add B to the product number for the drawer, preconfigured compartment layout or roll-out shelf, e.g., RF32-362406B
- For replacement parts or to retrofit this mechanism, order an RY01-B

PRODUCT NO. \_\_\_\_\_

B

### LOCK-OUT MECHANISM

RF85

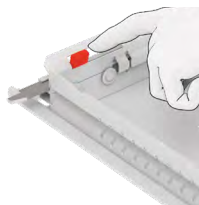

- For both drawers and roll-out shelves
- Locks drawers and roll-out shelves in an open position
- Activated manually, only when required
- Compatible with all drawer accessories
- Plastic bins in the back row may make it more difficult to activate the mechanism

PRODUCT NO. \_\_\_\_\_

RF85

### DRAWER LOCK

L3



- Compatible with all drawer dimensions
- Does not reduce the drawer's storage space
- Easy to retrofit
- To order: Add L3 to the product number for the drawer or preconfigured compartment layout, e.g., RF32-362406L3
- For replacement parts or to retrofit this mechanism, order an RY01-L3

PRODUCT NO. \_\_\_\_\_

L3



*"Bringing Order To Chaos"*

**w.w.Cannon, llc.**

Design. Layout. Build. Install.

1-800-442-3061  
www.wwcannon.com

*"Bringing Order To Chaos"*