



INDEX	PAGE(S)
<b>R Mobile Cabinet</b>	<b>38 - 39</b>
Preconfigured Models . . .	40 - 44
Accessories . . . . .	45 - 49
Components . . . . .	50 - 54
<b>L Compact Mobile Cabinet</b>	<b>55</b>
Preconfigured Models . . .	56 - 57
Accessories . . . . .	58 - 62
Components . . . . .	63 - 65

## R MOBILE CABINET

Rousseau's R Heavy-Duty Mobile Cabinet is one of the safest and most secure on the market. With a simple upward movement with just one hand on one of the drawer's ergonomic handles, the drawer opens with incredible ease, and the lock-in mechanism is activated so none of the other drawers can open.

It is also easy to change the cabinet configuration as the drawer order can be changed at any time. Our specialists will be happy to help you configure a cabinet personalized for you and tailored to your customers' specific requirements.

The R Heavy-Duty Mobile Cabinet is manufactured to meet the rigorous demands of industrial applications and is therefore one of the most durable on the market. Our research and development department has put the cabinet through multiple demanding tests for load capacity, impact resistance, and wear and tear, so we are confident in its excellent durability. Fitted with high-quality, resistant casters, it has been designed for intensive use in harsh work environments.

There is also an extensive range of options and accessories available to further customize it to your needs. There are 6 different tops, 2 types of handle (on the front and side), foldaway shelves and hanging side cabinets. Furthermore, you no longer need to worry about replacing complete units as your business grows and evolves because these options and accessories can be easily retrofitted.

The unique design of the R drawer is a trademark of Rousseau Metal Inc.



R5BHE-3019

**LIFETIME WARRANTY**  
The Rousseau drawer rolling mechanism is covered by a lifetime warranty.

## THE ROUSSEAU DIFFERENCE



The integrated lock-in mechanism activates easily with just one hand (right or left).



The full-width ergonomic handle provides a comfortable grip when opening the drawer.

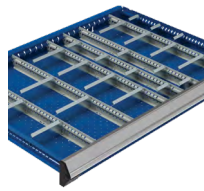

Variety of drawer accessories available: partitions, dividers, plastic bins, protective foam, etc.



Polyurethane casters for excellent maneuverability without marking floors.



Variety of cabinet accessories available: foldaway shelves, storage cabinets, wood tops, etc.



Industry-leading 400lb. load capacity per drawer.

## GENERAL DIMENSIONS

### HEIGHTS AVAILABLE



NOTE: The total height shown includes 6" casters and a 1 1/4"H top.

### WIDTH × DEPTH × HEIGHT

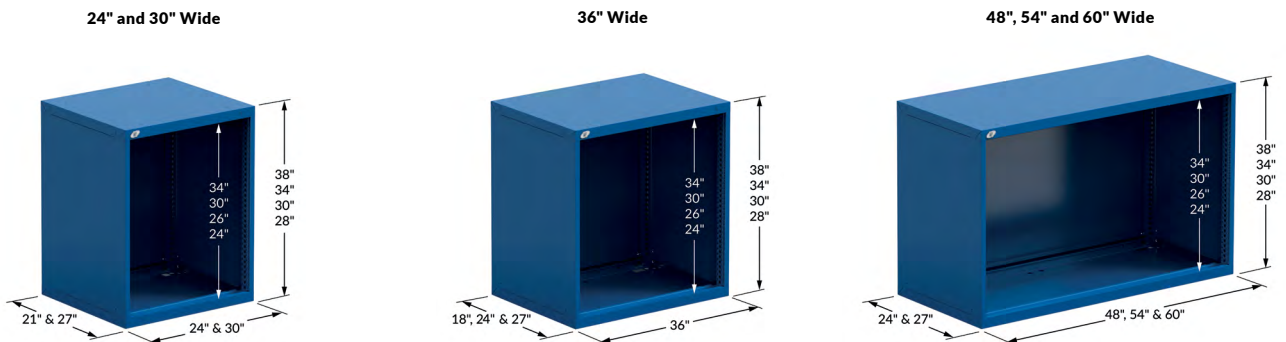

# PRECONFIGURED MODELS

HERE ARE SOME OF OUR MOST POPULAR PRECONFIGURED MODELS OF R HEAVY-DUTY MOBILE CABINETS

- Preconfigured models for 24"W cabinets have 4" casters, including two rigid and two swivel casters with total-lock brakes, as well as an econo lock-in mechanism (B)
- Preconfigured models for 30"W cabinets, or wider, have 6" casters, including two rigid and two swivel casters with total-lock brakes, as well as an integrated lock-in mechanism (A)
- All cabinets are fitted with a True One-Drawer-at-a-Time System
- The cabinets include a standard lock on the cabinet housing (and on the door)
- To add an L50 electronic lock to a door or to your R mobile cabinet, **see page 45**
- To add a stainless steel, painted steel, steel with rubber mat, wood or marine edge stainless steel top, **see page 46**
- All preconfigured models are factory assembled and ready to use. The doors are factory installed with hinges on the right-hand side. The hinges can be installed on the left upon request



NOTE: For interior drawer dimensions, **see pages 226-228**.

### IMPORTANT

Drawer compartments are included in all models. See the number of compartments and suggested layouts below.

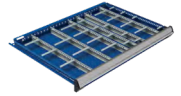

To order drawers without compartments, replace the last two digits of the model number with the next even number up.

e.g., R5BCD-2801 with R5BCD-2802 without



NUMBER OF COMPARTMENTS (LAYOUT CODE)

DRAWER DIMENSIONS	3"H TO 5"H	6"H TO 8"H	9"H AND HIGHER
24"W x 21"D	12 (0308)	9 (0206)	4 (0102)
24"W x 27"D	20 (0316)	12 (0209)	6 (0104)
30"W x 21"D	24 (0518)	12 (0308)	6 (0203)
30"W x 27"D	25 (0420)	12 (0308)	9 (0206)
36"W x 18"D	24 (0518)	8 (0304)	6 (0203)
36"W x 24"D	30 (0524)	12 (0308)	9 (0206)
48"W x 24"D	40 (0732)	15 (0410)	8 (0304)
48"W x 27"D	32 (0724)	15 (0410)	8 (0304)
54"W x 24"D	40 (0930)	18 (0512)	10 (0405)
54"W x 27"D	40 (0930)	18 (0512)	10 (0405)
60"W x 24"D	70 (1356)	24 (0716)	12 (0308)
60"W x 27"D	84 (1370)	21 (0614)	12 (0308)



Always distribute the load evenly to prevent the mobile cabinet from tipping.

## 24" WIDE (W x D x H)

Each model includes two front handles



4 DRAWERS	
R5BCD-2801	24" x 21" x 33 1/8"
R5BCG-2801	24" x 27" x 33 1/8"



4 DRAWERS	
R5BCD-2803	24" x 21" x 33 1/8"
R5BCG-2803	24" x 27" x 33 1/8"



3 DRAWERS	
R5BCD-2805	24" x 21" x 33 1/8"
R5BCG-2805	24" x 27" x 33 1/8"



6 DRAWERS	
R5BCD-3051	24" x 21" x 35 1/8"
R5BCG-3051	24" x 27" x 35 1/8"



5 DRAWERS	
R5BCD-3053	24" x 21" x 35 1/8"
R5BCG-3053	24" x 27" x 35 1/8"



5 DRAWERS	
R5BCD-3055	24" x 21" x 35 1/8"
R5BCG-3055	24" x 27" x 35 1/8"



5 DRAWERS	
R5BCD-3401	24" x 21" x 39 1/8"
R5BCG-3401	24" x 27" x 39 1/8"



7 DRAWERS	
R5BCD-3851	24" x 21" x 43 1/8"
R5BCG-3851	24" x 27" x 43 1/8"

## 30" AND 36" WIDE (W x D x H)

Each model includes one side handle



### 1 DRAWER / 1 DOOR / 1 BOTTOM SHELF

R5BDD-2801	30" x 21" x 35 1/2"
R5BDG-2801	30" x 27" x 35 1/2"
R5BEC-2801	36" x 18" x 35 1/2"
R5BEE-2801	36" x 24" x 35 1/2"



### 4 DRAWERS

R5BDD-2803	30" x 21" x 35 1/2"
R5BDG-2803	30" x 27" x 35 1/2"
R5BEC-2803	36" x 18" x 35 1/2"
R5BEE-2803	36" x 24" x 35 1/2"



### 6 DRAWERS

R5BDD-3001	30" x 21" x 37 1/2"
R5BDG-3001	30" x 27" x 37 1/2"
R5BEC-3001	36" x 18" x 37 1/2"
R5BEE-3001	36" x 24" x 37 1/2"



### 5 DRAWERS

R5BDD-3003	30" x 21" x 37 1/2"
R5BDG-3003	30" x 27" x 37 1/2"
R5BEC-3003	36" x 18" x 37 1/2"
R5BEE-3003	36" x 24" x 37 1/2"



### 5 DRAWERS

R5BDD-3005	30" x 21" x 37 1/2"
R5BDG-3005	30" x 27" x 37 1/2"
R5BEC-3005	36" x 18" x 37 1/2"
R5BEE-3005	36" x 24" x 37 1/2"



### 6 DRAWERS

R5BDD-3007	30" x 21" x 37 1/2"
R5BDG-3007	30" x 27" x 37 1/2"
R5BEC-3007	36" x 18" x 37 1/2"
R5BEE-3007	36" x 24" x 37 1/2"



### 4 DRAWERS

R5BDD-3019	30" x 21" x 37 1/2"
R5BDG-3019	30" x 27" x 37 1/2"
R5BEC-3019	36" x 18" x 37 1/2"
R5BEE-3019	36" x 24" x 37 1/2"



### 3 DRAWERS

R5BDD-3021	30" x 21" x 37 1/2"
R5BDG-3021	30" x 27" x 37 1/2"
R5BEC-3021	36" x 18" x 37 1/2"
R5BEE-3021	36" x 24" x 37 1/2"



### 1 ROLL-OUT SHELF / 4 DRAWERS

R5BDD-3015	30" x 21" x 37 1/2"
R5BDG-3015	30" x 27" x 37 1/2"
R5BEC-3015	36" x 18" x 37 1/2"
R5BEE-3015	36" x 24" x 37 1/2"

# PRECONFIGURED MODELS



7 DRAWERS

R5BDD-3801	30" x 21" x 45 1/2"
R5BDG-3801	30" x 27" x 45 1/2"
R5BEC-3801	36" x 18" x 45 1/2"
R5BEE-3801	36" x 24" x 45 1/2"



7 DRAWERS

R5BDD-3803	30" x 21" x 45 1/2"
R5BDG-3803	30" x 27" x 45 1/2"
R5BEC-3803	36" x 18" x 45 1/2"
R5BEE-3803	36" x 24" x 45 1/2"



4 DRAWERS / 1 DOOR / 1 BOTTOM SHELF

R5BDD-3805	30" x 21" x 45 1/2"
R5BDG-3805	30" x 27" x 45 1/2"
R5BEC-3805	36" x 18" x 45 1/2"
R5BEE-3805	36" x 24" x 45 1/2"

## 48" WIDE (W x D x H)

Each model includes one side handle



6 DRAWERS

R5BHE-3001	48" x 24" x 37 1/2"
R5BHG-3001	48" x 27" x 37 1/2"



4 DRAWERS

R5BHE-3019	48" x 24" x 37 1/2"
R5BHG-3019	48" x 27" x 37 1/2"



5 DRAWERS

R5BHE-3009	48" x 24" x 37 1/2"
R5BHG-3009	48" x 27" x 37 1/2"



5 DRAWERS

R5BHE-3011	48" x 24" x 37 1/2"
R5BHG-3011	48" x 27" x 37 1/2"



1 DRAWER / 1 DOUBLE DOOR / 1 BOTTOM SHELF

R5BHE-3013	48" x 24" x 37 1/2"
R5BHG-3013	48" x 27" x 37 1/2"



1 ROLL-OUT SHELF / 4 DRAWERS

R5BHE-3015	48" x 24" x 37 1/2"
R5BHG-3015	48" x 27" x 37 1/2"

## 54" WIDE (W x D x H)

Each model includes one side handle



5 DRAWERS		
R5BJE-3001	54" x 24" x 37½"	
R5BJG-3001	54" x 27" x 37½"	



4 DRAWERS		
R5BJE-3003	54" x 24" x 37½"	
R5BJG-3003	54" x 27" x 37½"	



4 DRAWERS		
R5BJE-3005	54" x 24" x 37½"	
R5BJG-3005	54" x 27" x 37½"	



5 DRAWERS		
R5BJE-3007	54" x 24" x 37½"	
R5BJG-3007	54" x 27" x 37½"	



4 DRAWERS		
R5BJE-3009	54" x 24" x 37½"	
R5BJG-3009	54" x 27" x 37½"	



7 DRAWERS		
R5BJE-3011	54" x 24" x 37½"	
R5BJG-3011	54" x 27" x 37½"	

## 60" WIDE (W x D x H)

Each model includes one side handle



5 DRAWERS		
R5BKE-3023	60" x 24" x 37½"	
R5BKG-3023	60" x 27" x 37½"	



4 DRAWERS		
R5BKE-3025	60" x 24" x 37½"	
R5BKG-3025	60" x 27" x 37½"	



4 DRAWERS		
R5BKE-3027	60" x 24" x 37½"	
R5BKG-3027	60" x 27" x 37½"	



5 DRAWERS		
R5BKE-3029	60" x 24" x 37½"	
R5BKG-3029	60" x 27" x 37½"	



5 DRAWERS		
R5BKE-3031	60" x 24" x 37½"	
R5BKG-3031	60" x 27" x 37½"	



6 DRAWERS		
R5BKE-3033	60" x 24" x 37½"	
R5BKG-3033	60" x 27" x 37½"	

# PRECONFIGURED MODELS

## 48" WIDE (2 × 24"W) AND 60" WIDE (2 × 30"W)

Each model includes one side handle and one brace to join the cabinets



8 DRAWERS		
R5DHG-3011	48" × 27" × 37½"	
R5DKG-3011	60" × 27" × 37½"	



7 DRAWERS		
R5DHG-3013	48" × 27" × 37½"	
R5DKG-3013	60" × 27" × 37½"	



8 DRAWERS / 1 ROLL-OUT SHELF		
R5DHG-3009	48" × 27" × 37½"	
R5DKG-3009	60" × 27" × 37½"	



8 DRAWERS / 1 DOOR / 1 ADJUSTABLE SHELF / 1 BOTTOM SHELF		
R5DHG-3801	48" × 27" × 45½"	
R5DKG-3801	60" × 27" × 45½"	



10 DRAWERS		
R5DHG-3809	48" × 27" × 45½"	
R5DKG-3809	60" × 27" × 45½"	



10 DRAWERS		
R5DHG-3807	48" × 27" × 45½"	
R5DKG-3807	60" × 27" × 45½"	

## SECURITY ACCESSORIES AND RECOMMENDATIONS

### VERTICAL SECURITY BAR



- Locks all drawers in a cabinet with a padlock on the right (A) or left (B)
- Safety hasp is located at the top of the bar to facilitate access
- Covers a bank of drawers from 20" to 34" high
- Allows full access to drawers even when installed against a wall
- More than one bar on the same cabinet can be installed (for different users)
- To order: Specify which side the bar is to be installed on, e.g., RB10-24LPA for the right-hand side

PRODUCT NO.	HEIGHT
RB10-20LP_	20"
RB10-24LP_	24"
RB10-26LP_	26"
RB10-30LP_	30"
RB10-34LP_	34"

NOTE: Vertical security bar A is not compatible with a drawer lock.

### RB10

### TRUE ONE-DRAWER-AT-A-TIME SYSTEM

### RB15



- Prevents multiple drawers from opening at the same time, which ensures the cabinet's stability and users' safety
- To order: Add A to the cabinet product number, e.g., RA30-302738A, see page 50
- To retrofit this mechanism, order an RB15 and specify the number of drawers and roll-out shelves in the cabinet, e.g., RB15-38-07 for a cabinet with seven drawers
- One kit per cabinet



Recommended for mobile cabinets and cabinets not anchored to the floor.

PRODUCT NO.	CABINET HEIGHT
RB15-28-__	28"
RB15-30-__	30"
RB15-34-__	34"
RB15-38-__	38"

## CENTRAL LOCKING SYSTEM

L3



- Locks all drawers and roll-out shelves in the cabinet at the same time
- Drawer and roll-out shelf positions can be reconfigured
- Easy to retrofit
- To order: Add L3 to the cabinet product number, e.g., RA30-302738L3
- For replacement parts or to retrofit this mechanism, order an RB00-DDHHL3

PRODUCT NO.  
L3

## CABINET SAFETY HASP

LP



- Locks all drawers and roll-out shelves in the cabinet at the same time
- Drawer and roll-out shelf positions can be reconfigured
- An alternative to an RB10 Vertical Security Bar
- Easy to retrofit
- To order: Add "LP" to the cabinet product number, e.g., RA30-302738LP
- For replacement parts or to retrofit this mechanism, order an RB00-DDHHL3

PRODUCT NO.  
LP

## ELECTRONIC LOCK FOR CABINET WITH DRAWERS

L50



- Electronically locks all drawers in the cabinet at the same time
- No key required
- Up to 20 different users can be programmed
- 4 to 8 digit access codes
- Simplifies access management to drawers
- To order the complete mechanism with a cabinet with drawers, order an RB00-DDHHL50
- To order as a replacement lock, order an HA48-L50
- One electronic lock system per cabinet. Electronically locks all drawers in the cabinet at the same time

PRODUCT NO.  
L50

## ELECTRONIC LOCK FOR DOORS

L50



- Electronically locks a cabinet door
- No key required
- Up to 20 different users can be programmed
- 4-8 digit access codes
- Compatible with single and double swing doors (RB61, RB62, RB66, and RB67)
- To order: Add L50 to the door product code, e.g. RB61-3620L50

PRODUCT NO.  
L50

## R CABINET BUMPERS

RB9J



- Protects R cabinets from bumps and damage
- Protection kit for all four corners of cabinets
- Vertical bumpers and endcaps made from resistant soft PVC
- Quick and easy installation with double-sided adhesive tape
- Tool-free installation
- To order: Specify the housing height required, e.g., RB9J-30 02 for installation on a 30"H R cabinet and an RD01 side housing

PRODUCT NO.	COMPATIBLE WITH
RB9J-__ 01	RA30 cabinet
RB9J-__ 02	RA30 cabinet and RD01 side housing
RB9J-__ 03	RA30 cabinet and 1 RC02/RC04 side panel
RB9J-__ 04	RA30 cabinet and 2 RC02/RC04 side panels

## SECURITY PANEL

RF91



- Blocks access between two drawers with locks
- Usable space in the cabinet is reduced by 1"
- Installs between two drawers
- Divides the cabinet up for use by more than one user
- To order: Specify the width and depth required, e.g., RF91-36 24 for a 36"W x 24"D panel

PRODUCT NO.  
RF91-\_\_ \_\_

NOTES: Not compatible with RB10 vertical security bars.  
Not compatible with RC00 foldaway shelves.  
Not compatible with RB75 and RB76 doors with frame.



# ACCESSORIES

## CABINET TOPS

### STEEL TOP WITH RUBBER MAT

RC32



- ½"-thick non-slip neoprene surface
- Includes edges on the sides and back
- Height: 1"

### LAMINATED HARDWOOD TOP

WS14



- Top for general industrial applications
- Made from varnished hardwood slats
- Includes a 90° radius front edge for extra comfort
- High impact resistance
- Attractive appearance
- Thickness: 1¾"

### STAINLESS STEEL TOP

RC35



- 16ga stainless steel: RC35-WWDD
- 12ga stainless steel: RC35-WWDD-12
- Acts as a work surface and protects the cabinet from impacts
- Particle board top with stainless steel cover (#4 brushed finish)
- Excellent corrosion and chemical resistance
- Top complies with CARB regulations on formaldehyde emissions
- Includes welded corners for an attractive appearance
- Thickness: 1¾"
- To order a 12ga stainless steel top, add 12 to the product number

### MARINE EDGE STAINLESS STEEL TOP

RC35



- Marine edge 16ga stainless steel: RC35-WWDD-16M
- Marine edge 12ga stainless steel: RC35-WWDD-12M
- Prevents small objects or liquids from falling or spilling from the work surface
- Acts as a work surface and protects the cabinet from impacts
- Particle board top with stainless steel cover (#4 brushed finish)
- Excellent corrosion and chemical resistance
- Top complies with CARB regulations on formaldehyde emissions
- Includes welded corners for an attractive appearance
- Thickness: 1¾"
- To order: Specify the steel gauge required, e.g., RC35-WWDD-16M for a marine edge 16ga stainless steel top

### PAINTED STEEL TOP

RC37



- Acts as a work surface and protects the cabinet from impacts
- Particle board top with painted steel cover
- Top complies with CARB regulations on formaldehyde emissions
- Includes welded corners for an attractive appearance
- Thickness: 1¾"



DIMENSIONS		TYPE OF TOP				
W	D	STEEL TOP WITH RUBBER MAT	LAMINATED HARDWOOD*	STAINLESS STEEL	MARINE EDGE STAINLESS STEEL TOP*	PAINTED STEEL
24"	21"	RC32-2421-01	WS14-2421A	RC35-2421-__**		
	27"	RC32-2427-01	WS14-2427A	RC35-2427-__		
30"	21"	RC32-3021-01	WS14-3021A	RC35-3021-__**		
	27"	RC32-3027-01	WS14-3027A	RC35-3027-__	RC35-3027-__M	RC37-3027
36"	18"	RC32-3618-01	WS14-3618A			RC37-3618
	24"	RC32-3624-01	WS14-3624A	RC35-3624-__	RC35-3624-__M	RC37-3624
48"	24"	RC32-4824-01	WS14-4824A	RC35-4824-__	RC35-4824-__M	RC37-4824
	27"	RC32-4827-01	WS14-4827A	RC35-4827-__	RC35-4827-__M	RC37-4827
54"	24"	RC32-5424-01	WS14-5424A	RC35-5424-__**	RC35-5424-__M	RC37-5424
	27"	RC32-5427-01	WS14-5427A	RC35-5427-__**	RC35-5427-__M	RC37-5427
60"	24"	RC32-6024-01	WS14-6024A	RC35-6024-__	RC35-6024-__M	RC37-6024
	27"	RC32-6027-01	WS14-6027A	RC35-6027-__	RC35-6027-__M	RC37-6027
66"	24"	RC32-6624-01	WS14-6624A	RC35-6624-__	RC35-6624-__M	RC37-6624
	27"	RC32-6627-01	WS14-6627A	RC35-6627-__	RC35-6627-__M	RC37-6627
72"	24"	RC32-7224-01	WS14-7224A	RC35-7224-__	RC35-7224-__M	RC37-7224
	27"	RC32-7227-01	WS14-7227A	RC35-7227-__	RC35-7227-__M	RC37-7227
78"	24"	RC32-7824-01	WS14-7824A	RC35-7824-__	RC35-7824-__M	RC37-7824
	27"	RC32-7827-01	WS14-7827A	RC35-7827-__	RC35-7827-__M	RC37-7827

NOTES: \* Please check with your Customer Service representative for lead times.  
 \*\*16ga only  
 For compatibility with doors with frame, choose a top 3" deeper than your cabinet, e.g., 27"D cabinet + door with 3"D frame = 30"D top

## TOPS ACCESSORIES

### FOLDAWAY SHELF

### RC00

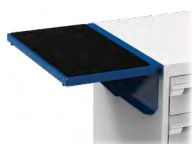

- Load capacity: 50lb. (evenly distributed)
- Includes a protective rubber surface
- Compatible with optional RC01 side and back stops for foldaway shelf

PRODUCT NO.	W x D
RC00-151801	15" x 18"
RC00-152101	15" x 21"
RC00-152401	15" x 24"
RC00-152701	15" x 27"

### SIDE OR BACK STOPS FOR FOLDAWAY SHELF

### RC01



- Use the 15" stop for front or back of shelf
- Use the 18", 21", 24" or 27" stop for the sides
- Height: 1"

PRODUCT NO.	WIDTH
RC01-15	15"
RC01-18	18"
RC01-21	21"
RC01-24	24"
RC01-27	27"

### BACK OR SIDE STOPS

### WS18 / WS98



- Painted steel: WS18
- Stainless steel: WS98
- Can be installed on back or sides depending on top dimensions
- Installs on WS14 and RC37 tops
- Height: 5". Clears top by approx. 3¼"
- To order: Add the type of steel required to the product number

PRODUCT NO.	WIDTH
WS__-2405	24"
WS__-2705	27"
WS__-3005	30"
WS__-3605	36"
WS__-4205	42"
WS__-4805	48"
WS__-5405	54"
WS__-6005	60"
WS__-7205	72"

NOTE: Not compatible with RC32 and RC35 tops.

## HANGING SIDE CABINETS

### HANGING SIDE CABINET - SIDE ACCESS



- Side housing specifically designed to be installed on the side of RA30 cabinets
- Includes one bottom shelf
- The shelves are adjustable in 1" increments c/c
- The shelves are compatible with SH52 Partial Dividers
- Includes holes on the top so a common work surface can be installed on the main RA30 cabinet
- Door opens 180° for full access to items stored inside
- Door includes a standard lock
- 600lb. load capacity
- Choice of doors. Add one of the following to the product number:
  - 01: Solid door
  - 02: Polycarbonate door

HEIGHT	WIDTH×DEPTH		NO. OF ADJUSTABLE SHELVES (RD05)
	24"W×14"D	27"W×14"D	
24"	R5QCA-24__	R5QPA-24__	-
28"	R5QCA-28__	R5QPA-28__	1
30"	R5QCA-30__	R5QPA-30__	1
34"	R5QCA-34__	R5QPA-34__	1
38"	R5QCA-38__	R5QPA-38__	2
For Cabinet	24"D	27"D	



R5XHE-1001

NOTE: For compatibility with a work surface, choose a top 12" wider than your cabinet, e.g., RC\_\_-4824 for a 36"W×24"D mobile cabinet

### HANGING SIDE CABINET - FRONT ACCESS



- Side housing specifically designed to be installed on the side of RA30 cabinets
- The shelves are adjustable in 1" increments c/c
- The adjustable and bottom shelves are compatible with SH52 Partial Dividers
- Roll-out shelf: 175lb. load capacity, 75% extension
- Includes holes on the top so a common work surface can be installed on the main RA30 cabinet
- Door opens 180° for full access to items stored inside
- Door includes a standard lock
- 500lb. load capacity
- Choice of configurations. Add one of the following to the product number:
  - Bottom shelf (RB23) and adjustable shelves (RB20):
    - 03: Solid door
    - 05: Polycarbonate door
  - Roll-out shelves (RF55):
    - 04: Solid door
    - 06: Polycarbonate door

HEIGHT	WIDTH×DEPTH				NO. OF ADJUSTABLE SHELVES (RB20)	NO. OF ROLL-OUT SHELVES (RF55)
	24"W×18"D	24"W×21"D	24"W×24"D	24"W×27"D		
28"	R5QCC-28__	R5QCD-28__	R5QCE-28__	R5QCG-28__	1	2
30"	R5QCC-30__	R5QCD-30__	R5QCE-30__	R5QCG-30__	1	2
34"	R5QCC-34__	R5QCD-34__	R5QCE-34__	R5QCG-34__	1	2
38"	R5QCC-38__	R5QCD-38__	R5QCE-38__	R5QCG-38__	2	3
For Cabinet	18"D	21"D	24"D	27"D		



It is recommended to install this product on a 48"W cabinet or wider

NOTE: For compatibility with a work surface, choose a top 24" wider than your cabinet, e.g., RC\_\_-7224 for a 48"W×24"D mobile cabinet

## SIDE PANELS

### SIDE UTILITY PANEL

RC02

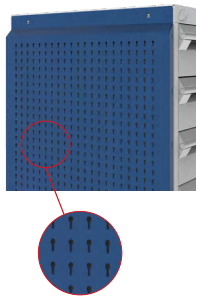

- 5S storage accessory
- Maximizes the cabinet's storage space
- Installs on the sides of R cabinets
- Quick and easy installation
- Includes perforations spaced 1" apart c/c for hanging a range of hooks
- Load capacity: 50lb./sq. ft., 500lb. max. per panel
- Compatible with WM9F, WM9G, WM9H, WM9J and WM9L light-duty hooks, and WM9A and WM9B heavy-duty hooks
- Compatible with WMQ9 tool holders, WM9C bin rails, WM9D can holders, WM9M and WM9N hooks, WM9P spool and roll holders, and WM21 shelves
- Available in all standard R cabinet dimensions (depth, height)
- To order: Specify the housing height required, e.g., RC02-2434 for a 24"D x 34"H housing

PRODUCT NO.	CABINET DEPTH	NO. OF HOLES
RC02-18 __	18"	15
RC02-21 __	21"	18
RC02-24 __	24"	21
RC02-27 __	27"	24

NOTE: Full height installation only.

### SIDE PANEL FOR PLASTIC BINS

RC04

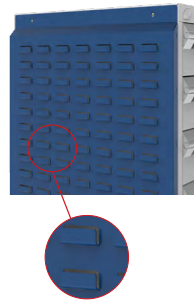

- 5S storage accessory
- Maximizes the cabinet's storage space
- Installs on the sides of R cabinets
- Quick and easy installation
- Holds RG20 plastic bins
- Compatible with all commercially available brands of plastic bins with a hanging lip
- Available in all standard R cabinet dimensions (depth, height)
- To order: Specify the housing height required: RC04-2434 for a 24"D x 34"H housing

PRODUCT NO.	CABINET DEPTH
RC04-18 __	18"
RC04-21 __	21"
RC04-24 __	24"
RC04-27 __	27"

NOTE: Full height installation only.

## AVAILABLE COMBINATIONS

To find the right combination for your intended usage, ask yourself:

How wide do I want the cabinet and what load capacity do I need? Here are the different options available:

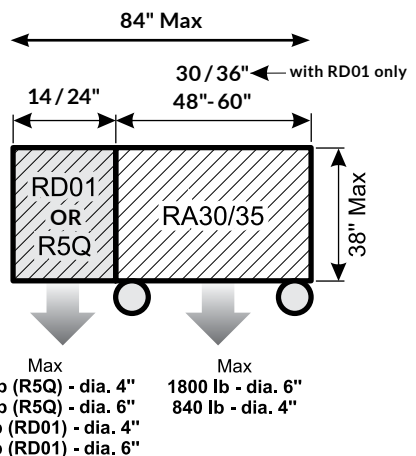
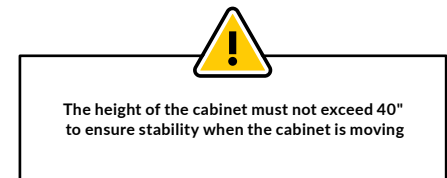
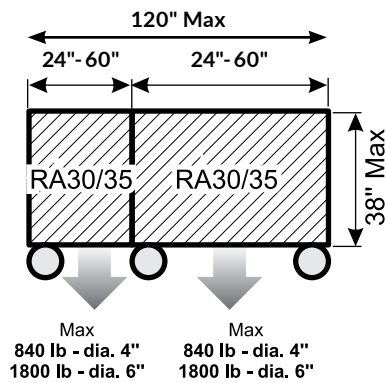
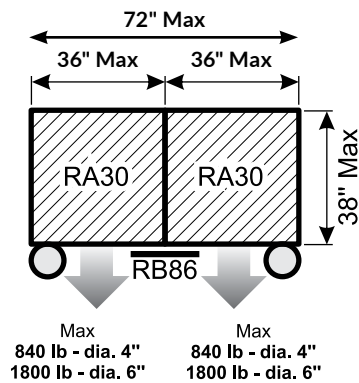
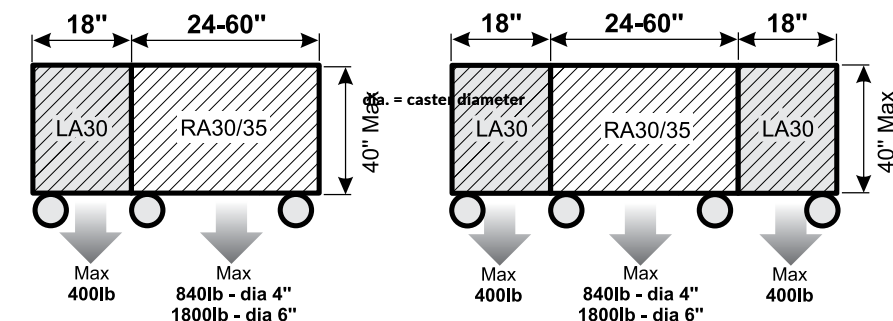

dia. = caster diameter

### HOUSINGS

#### R HEAVY-DUTY CABINET HOUSING

RA30

- Compatible with modular drawers, roll-out shelves, adjustable shelves and bottom shelves
- Compatible with integrated doors
- The housing units include knockouts:
  - on the top for installing accessories or work surfaces
  - on the sides and back for installing accessories
- To order a central locking system, add L3 to the product number, [see page 45](#)

- To order a safety hasp, add LP to the product number, [see page 45](#)
- For factory installation of an electronic lock, order an RB00-DDHHL50, [see page 45](#)
- To order a true One-Drawer-at-a-Time mechanism, add A to the product number

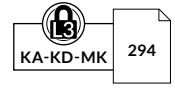

24" and 30" Wide

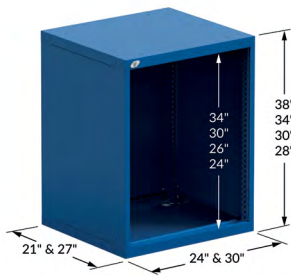

36" Wide

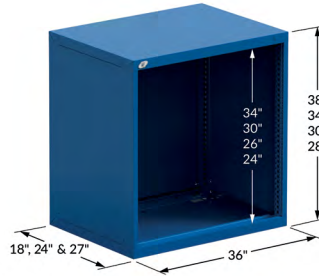

48", 54" and 60" Wide

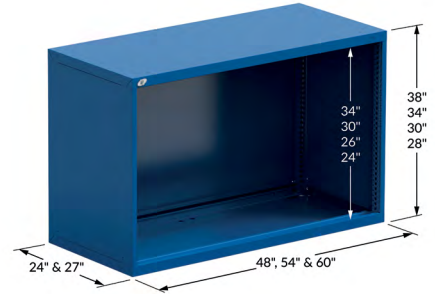

PRODUCT NO.	TOTAL HEIGHT	INSIDE HEIGHT
<b>24" x 21"</b>		
RA30-242124__	24"	20"
RA30-242128__	28"	24"
RA30-242130__	30"	26"
RA30-242134__	34"	30"
RA30-242138__	38"	34"
<b>24" x 27"</b>		
RA30-242724__	24"	20"
RA30-242728__	28"	24"
RA30-242730__	30"	26"
RA30-242734__	34"	30"
RA30-242738__	38"	34"
<b>30" x 21"</b>		
RA30-302124__	24"	20"
RA30-302128__	28"	24"
RA30-302130__	30"	26"
RA30-302134__	34"	30"
RA30-302138__	38"	34"
<b>30" x 27"</b>		
RA30-302724__	24"	20"
RA30-302728__	28"	24"
RA30-302730__	30"	26"
RA30-302734__	34"	30"
RA30-302738__	38"	34"
<b>36" x 18"</b>		
RA30-361824__	24"	20"
RA30-361828__	28"	24"
RA30-361830__	30"	26"
RA30-361834__	34"	30"
RA30-361838__	38"	34"
<b>36" x 24"</b>		
RA30-362424__	24"	20"
RA30-362428__	28"	24"
RA30-362430__	30"	26"
RA30-362434__	34"	30"
RA30-362438__	38"	34"

PRODUCT NO.	TOTAL HEIGHT	INSIDE HEIGHT
<b>36" x 27"</b>		
RA30-362724__	24"	20"
RA30-362728__	28"	24"
RA30-362730__	30"	26"
RA30-362734__	34"	30"
RA30-362738__	38"	34"
<b>48" x 24"</b>		
RA30-482424__	24"	20"
RA30-482428__	28"	24"
RA30-482430__	30"	26"
RA30-482434__	34"	30"
RA30-482438__	38"	34"
<b>48" x 27"</b>		
RA30-482724__	24"	20"
RA30-482728__	28"	24"
RA30-482730__	30"	26"
RA30-482734__	34"	30"
RA30-482738__	38"	34"
<b>54" x 24"</b>		
RA30-542424__	24"	20"
RA30-542428__	28"	24"
RA30-542430__	30"	26"
RA30-542434__	34"	30"
RA30-542438__	38"	34"

PRODUCT NO.	TOTAL HEIGHT	INSIDE HEIGHT
<b>54" x 27"</b>		
RA30-542724__	24"	20"
RA30-542728__	28"	24"
RA30-542730__	30"	26"
RA30-542734__	34"	30"
RA30-542738__	38"	34"
<b>60" x 24"</b>		
RA30-602424__	24"	20"
RA30-602428__	28"	24"
RA30-602430__	30"	26"
RA30-602434__	34"	30"
RA30-602438__	38"	34"
<b>60" x 27"</b>		
RA30-602724__	24"	20"
RA30-602728__	28"	24"
RA30-602730__	30"	26"
RA30-602734__	34"	30"
RA30-602738__	38"	34"

#### BRACES FOR DOUBLE MOBILE CABINET

RB86



- Sold in pairs
- For attaching two housings together (36"W or smaller) to create a double mobile cabinet
- All cabinet tops are compatible with double cabinets, [see page 46](#)
- Cabinets are factory assembled

PRODUCT NO.  
RB86-01

## DOORS

### SINGLE INTEGRATED DOOR, SOLID OR POLYCARBONATE



RB62 / RB61



- Integrated door: RB62
- Polycarbonate integrated door: RB61
- Single door for 18"W, 24"W, 30"W and 36"W cabinets
- RB62 integrated doors have a finished back for increased rigidity and aesthetics
- RB61 integrated polycarbonate doors have excellent impact resistance
- Integrated doors are adjustable vertically and horizontally
- Compatible with RB23/RB25 Bottom Shelf and RB21/RB20 Adjustable Shelf
- Opens 180° for full access to items stored inside
- Factory installed on RA30 cabinet housings
- Some integrated door heights can be combined with drawers mounted above or below. For the latter case, you must order an RB20/RB21 Adjustable Shelf and install it above the bank of drawers
- Three types of lock available: L3 for a standard central lock, LP for a safety hasp or L50 for an electronic lock
- To order: Specify the type of door and lock required, e.g., RB61-3034L50 for a 30"W x 34"H integrated polycarbonate door and L50 electronic lock
- To replace the lock on a single integrated solid or polycarbonate door with an electronic lock, order an: RY50-L50

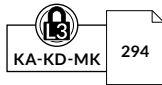

PRODUCT NO.	W x H
RB_-2420_	24" x 20"
RB_-2424_	24" x 24"
RB_-2426_	24" x 26"
RB_-2430_	24" x 30"
RB_-2434_	24" x 34"
RB_-3020_	30" x 20"
RB_-3024_	30" x 24"
RB_-3026_	30" x 26"
RB_-3030_	30" x 30"
RB_-3034_	30" x 34"

PRODUCT NO.	W x H
RB_-3620_	36" x 20"
RB_-3624_	36" x 24"
RB_-3626_	36" x 26"
RB_-3630_	36" x 30"
RB_-3634_	36" x 34"

NOTE: Not compatible with RF31/RF35 drawers or RF40/RF44 roll-out shelves.

### DOUBLE INTEGRATED DOORS, SOLID OR POLYCARBONATE



RB67 / RB66

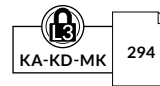

- Integrated door: RB67
- Polycarbonate integrated door: RB66
- Double doors for 30"W, 36"W, 48"W, 54"W and 60"W cabinets
- RB67 integrated doors have a finished back for increased rigidity and aesthetics
- RB66 double integrated polycarbonate doors have excellent impact resistance
- Integrated doors are adjustable vertically and horizontally
- Compatible with RB21 Adjustable Shelf
- Opens 180° for full access to items stored inside
- Factory installed on RA30 cabinet housings
- Some integrated door heights can be combined with drawers mounted above or below. You must order an RB20 / RB21 Adjustable Shelf and install it above the bank of drawers for drawers mounted below, or an RB65 crossbar for drawers mounted above
- Three types of lock available: L3 for a standard central lock, LP for a safety hasp or L50 for an electronic lock
- To order: Specify the type of door and lock required, e.g., RB66-4820L3 for 48"W x 20"H double integrated polycarbonate doors and a standard central lock
- To replace the lock on double integrated solid or polycarbonate doors with an electronic lock, order an: RY51-L50

PRODUCT NO.	W x H
RB_-3020_	30" x 20"
RB_-3024_	30" x 24"
RB_-3026_	30" x 26"
RB_-3030_	30" x 30"
RB_-3034_	30" x 34"
RB_-3040_	30" x 40"
RB_-3054_	30" x 54"
RB_-3620_	36" x 20"
RB_-3624_	36" x 24"
RB_-3626_	36" x 26"
RB_-3630_	36" x 30"
RB_-3634_	36" x 34"
RB_-4820_	48" x 20"
RB_-4824_	48" x 24"
RB_-4826_	48" x 26"
RB_-4830_	48" x 30"

PRODUCT NO.	W x H
RB_-4834_	48" x 34"
RB_-5420_	54" x 20"
RB_-5424_	54" x 24"
RB_-5426_	54" x 26"
RB_-5430_	54" x 30"
RB_-5434_	54" x 34"
RB_-6020_	60" x 20"
RB_-6024_	60" x 24"
RB_-6026_	60" x 26"
RB_-6030_	60" x 30"
RB_-6034_	60" x 34"

NOTES: Not compatible with RF31/RF35 drawers or RF40/RF44 roll-out shelves.  
Not compatible with RB25 Bottom Shelf.

### CROSSBAR FOR DOUBLE INTEGRATED DOORS

RB65



- Required for double integrated doors with drawers above
- Required a crossbar for double integrated doors with an electronic lock and drawers above, complete the following product code: RB65-WWL50

PRODUCT NO.	WIDTH
RB65-30_	30"
RB65-36_	36"
RB65-48_	48"
RB65-54_	54"
RB65-60_	60"

## DRAWERS, SHELVES AND LOCKING / SECURITY MECHANISMS

### HEAVY-DUTY MODULAR DRAWER



- Painted steel drawer: RF31
- Drawer with stainless steel front and gray painted steel interior: RF35
- 400lb. load capacity, 100% extension
- Heavy-duty construction
- Easy to install
- Vast choice of accessories available to customize the drawer to your storage needs, [see pages 242-247](#)
- Drawer heights available: 3", 4", 5", 6", 7", 8", 9", 10", 12" and 14"
- For preconfigured modular drawers with compartments, [see pages 224-241](#)
- To order: Add the drawer height to the product number, specify the type of drawer front required (painted steel or stainless steel) and the type of lock-in mechanism required, e.g., [RF31-362406A](#)

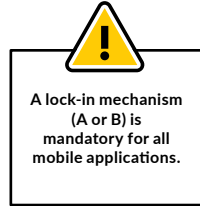

PRODUCT NO.	W x D
RF__-2421__	24" x 21"
RF__-2427__	24" x 27"
RF__-3021__	30" x 21"
RF__-3027__	30" x 27"
RF__-3618__	36" x 18"
RF__-3624__	36" x 24"
RF__-4824__	48" x 24"
RF__-4827__	48" x 27"
RF__-5424__	54" x 24"
RF__-5427__	54" x 27"
RF__-6024__	60" x 24"
RF__-6027__	60" x 27"

### HEAVY-DUTY 3-SIDED ACCESS ROLL-OUT SHELF

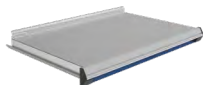

- 400lb. load capacity, 100% extension
- Heavy-duty construction
- Easy to install
- Galvanized steel top with 1½"H back
- Total height: 5"
- Can be used as a work surface
- To order: Specify the type of lock-in mechanism required, e.g., [RF44-3624A](#)

PRODUCT NO.	W x D
RF44-2421_	24" x 21"
RF44-2427_	24" x 27"
RF44-3021_	30" x 21"
RF44-3027_	30" x 27"
RF44-3618_	36" x 18"
RF44-3624_	36" x 24"
RF44-3627_	36" x 27"

PRODUCT NO.	W x D
RF44-4824_	48" x 24"
RF44-4827_	48" x 27"
RF44-5424_	54" x 24"
RF44-5427_	54" x 27"
RF44-6024_	60" x 24"
RF44-6027_	60" x 27"

### HEAVY-DUTY FRONT ACCESS ROLL-OUT SHELF



- 400lb. load capacity, 100% extension
- Heavy-duty construction
- Easy to install
- Painted steel with 3"H edges on the sides and back
- Total height: 6"
- Full access to contents
- To order: Specify the type of lock-in mechanism required, e.g., [RF40-3624A](#)

PRODUCT NO.	W x D	PRODUCT NO.	W x D
RF40-2421_	24" x 21"	RF40-4824_	48" x 24"
RF40-2427_	24" x 27"	RF40-4827_	48" x 27"
RF40-3021_	30" x 21"	RF40-5424_	54" x 24"
RF40-3027_	30" x 27"	RF40-5427_	54" x 27"
RF40-3618_	36" x 18"	RF40-6024_	60" x 24"
RF40-3624_	36" x 24"	RF40-6027_	60" x 27"
RF40-3627_	36" x 27"		

### INTEGRATED LOCK-IN MECHANISM

**A**



- Automatically activated when lifting the handle up
- The drawer or roll-out shelf can be opened with one hand only
- Closes with a simple push
- Stops drawer or roll-out shelf from opening on their own
- Easy to retrofit
- To order: Add **A** to the product number for the drawer, preconfigured compartment layout or roll-out shelf, e.g., [RF31-362406A](#)
- For replacement parts or to retrofit this mechanism, order an [RY08-WWA](#)

PRODUCT NO.  
A

### ECONO LOCK-IN MECHANISM

**B**



- Activated with the right hand by sliding the mechanism with thumb
- The drawer or roll-out shelf closes without having to reactivate the slide mechanism
- Stops drawer or roll-out shelf from opening on their own
- Easy to retrofit
- To order: Add **B** to the product number for the drawer, preconfigured compartment layout or roll-out shelf, e.g., [RF31-362406B](#)
- For replacement parts or to retrofit this mechanism, order an [RY01-B](#)

PRODUCT NO.  
B

## DRAWER LOCK

L3



- Compatible with all drawer dimensions
- Does not reduce the drawer's storage space
- To order: Add L3 to the product number for the drawer or preconfigured compartment layout, e.g., RF31-362406L3
- For replacement parts or to retrofit this mechanism, order an RY01-L3

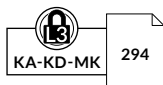

PRODUCT NO. \_\_\_\_\_  
L3 \_\_\_\_\_

## LOCK-OUT MECHANISM

RF85

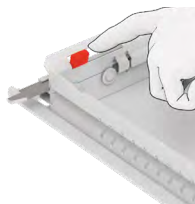

- For both drawers and roll-out shelves
- Locks drawers and roll-out shelves in an open position
- Activated manually, only when required
- Compatible with all drawer accessories

PRODUCT NO. \_\_\_\_\_  
RF85 \_\_\_\_\_

NOTE: Plastic bins in the back row may make it more difficult to activate the mechanism

## ADJUSTABLE SHELF

RB20 / RB21



- For storage of bulky items
- The back and side edges prevent objects from falling to the bottom of the cabinet
- Height can be adjusted in 1" increments c/c
- Up to 400lb. load capacity, evenly distributed
- Includes perforations on the top spaced 3" apart c/c for inserting SH52 Partial Dividers. Allow 3" vertical clearance for installation, [see page 13](#)

PRODUCT NO.	W x D	LOAD CAPACITY (LB.)
RB20-2421	24" x 21"	200
RB20-2427	24" x 27"	200
RB21-3021	30" x 21"	400
RB21-3027	30" x 27"	400
RB21-3618	36" x 18"	400
RB21-3624	36" x 24"	400
RB21-4824	48" x 24"	400
RB21-4827	48" x 27"	400
RB21-5424	54" x 24"	400
RB21-5427	54" x 27"	400
RB21-6024	60" x 24"	400
RB21-6027	60" x 27"	400

NOTE: Actual usable space is 2" c/c less than the height, 2 1/8" c/c less than the width and 4" c/c less than the depth.

## BOTTOM SHELF

RB23 / RB25



- For storage of bulky items
- The back and side edges prevent objects from falling to the bottom of the cabinet
- Up to 400lb. load capacity, evenly distributed
- Includes perforations on the top spaced 3" apart c/c for inserting SH52 Partial Dividers. Allow 3" vertical clearance for installation, [see page 13](#)

PRODUCT NO.	W x D	LOAD CAPACITY (LB.)
RB23-2421	24" x 21"	200
RB23-2427	24" x 27"	200
RB25-3021	30" x 21"	400
RB25-3027	30" x 27"	400
RB25-3618	36" x 18"	400
RB25-3624	36" x 24"	400
RB25-4824	48" x 24"	400
RB25-4827	48" x 27"	400
RB25-5424	54" x 24"	400
RB25-5427	54" x 27"	400
RB25-6024	60" x 24"	400
RB25-6027	60" x 27"	400

NOTES: Actual usable space is 2" c/c less than the height, 2 1/8" c/c less than the width and 4" c/c less than the depth.

For compatibility with double integrated doors or integrated sliding doors, order an adjustable shelf.



## MOBILITY

### CASTERS

### RB81 / RB84 / RB8E



- Sold in pairs
- Three types of casters available: rigid, swivel and swivel with total-lock brake (on wheel and swivel)
- Dark gray, non-marking polyurethane tread
- Superior industrial quality

PRODUCT NO.	CASTER TYPE	CAPACITY	HEIGHT	
			WHEEL	TOTAL
RB81-01	Rigid	440 lb	4"	5 1/8"
RB81-02	Swivel	440 lb	4"	5 1/8"
RB81-03	Swivel with total-lock brake	440 lb	4"	5 1/8"
RB84-01	Rigid	1100 lb	6"	7 1/2"
RB84-02	Swivel	1100 lb	6"	7 1/2"
RB84-03	Swivel with total-lock brake	1100 lb	6"	7 1/2"
RB8E-02	Swivel caster directional locking kit for swivel casters (x2)			

NOTES: The casters install directly under an R cabinet (without base).  
Not compatible with 18"W R cabinets.

### QUIET CASTERS

### RB8C / RB8D



- Sold in pairs
- Smooth and quieter rolling
- Two types of casters available: rigid and swivel with total-lock brake (on wheel and swivel)
- Blue, hard-wearing polyurethane tread for quiet and easy maneuvering
- Superior industrial quality

PRODUCT NO.	CASTER TYPE	CAPACITY	HEIGHT	
			WHEEL	TOTAL
RB8C-01	Quiet, rigid	660 lb	4"	5 1/8"
RB8C-03	Quiet, swivel with total-lock brake	660 lb	4"	5 1/8"
RB8D-01	Quiet, rigid	1100 lb	6"	7 1/2"
RB8D-03	Quiet, swivel with total-lock brake	1100 lb	6"	7 1/2"

NOTES: The casters install directly under an R cabinet (without base).  
Not compatible with 18"W R cabinets.

### EXTENDED BASE FOR CASTERS

### RB88



- Provides stability when the cabinet has fewer than four drawers and/or when the load is not evenly distributed (e.g., One drawer supporting 400lb. and the other three supporting 50lb.)
- Compatible with 4" and 6" casters

PRODUCT NO.	DEPTH
RB88-18-05	18"
RB88-21-05	21"
RB88-24-05	24"
RB88-27-05	27"

### SIDE HANDLE

### RB90



- Installs on the side of single or double cabinets. Specify which side when ordering (left or right)
- Anodized aluminum with heavy-duty plastic end caps
- Wide-grip handle for easier cabinet handling

PRODUCT NO.	HANDLE WIDTH	FOR CABINET
RB90-18	15"	18"D
RB90-21	18"	21"D
RB90-24	21"	24"D
RB90-27	24"	27"D

### FRONT HANDLES

### RB92



- Sold in pairs
- Installs on the front of 24"W and 30"W single cabinets
- Black resistant plastic

PRODUCT NO.
RB92-01

NOTE: Not compatible with the L50 electronic lock system.  
Not compatible with 18"W R cabinets.

**w.w.Cannon, Inc.**

**Design. Layout. Build. Install.**

1-800-442-3061

www.wwcannon.com