

SUBDIVIDING R DRAWERS

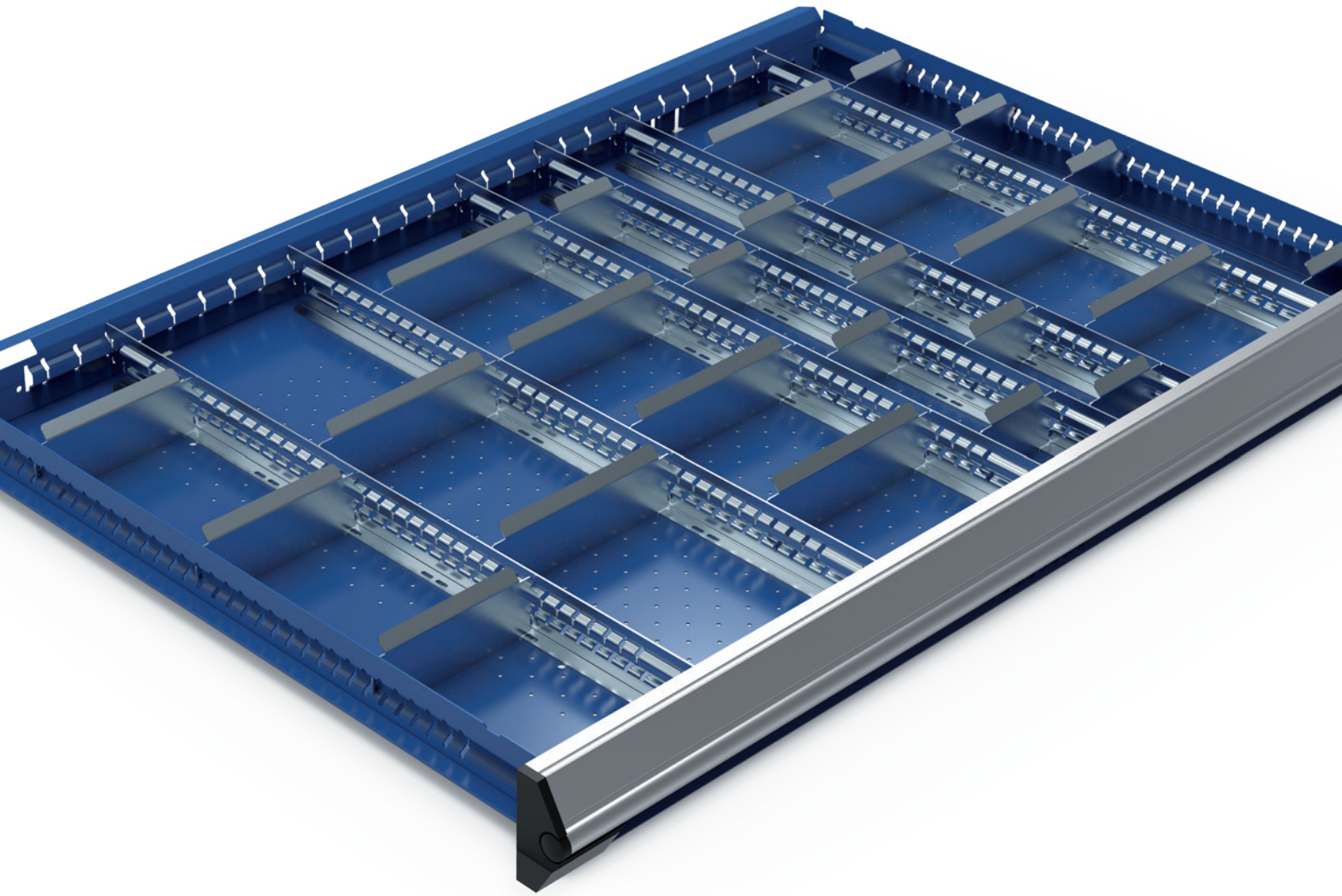

COMPARTMENTS

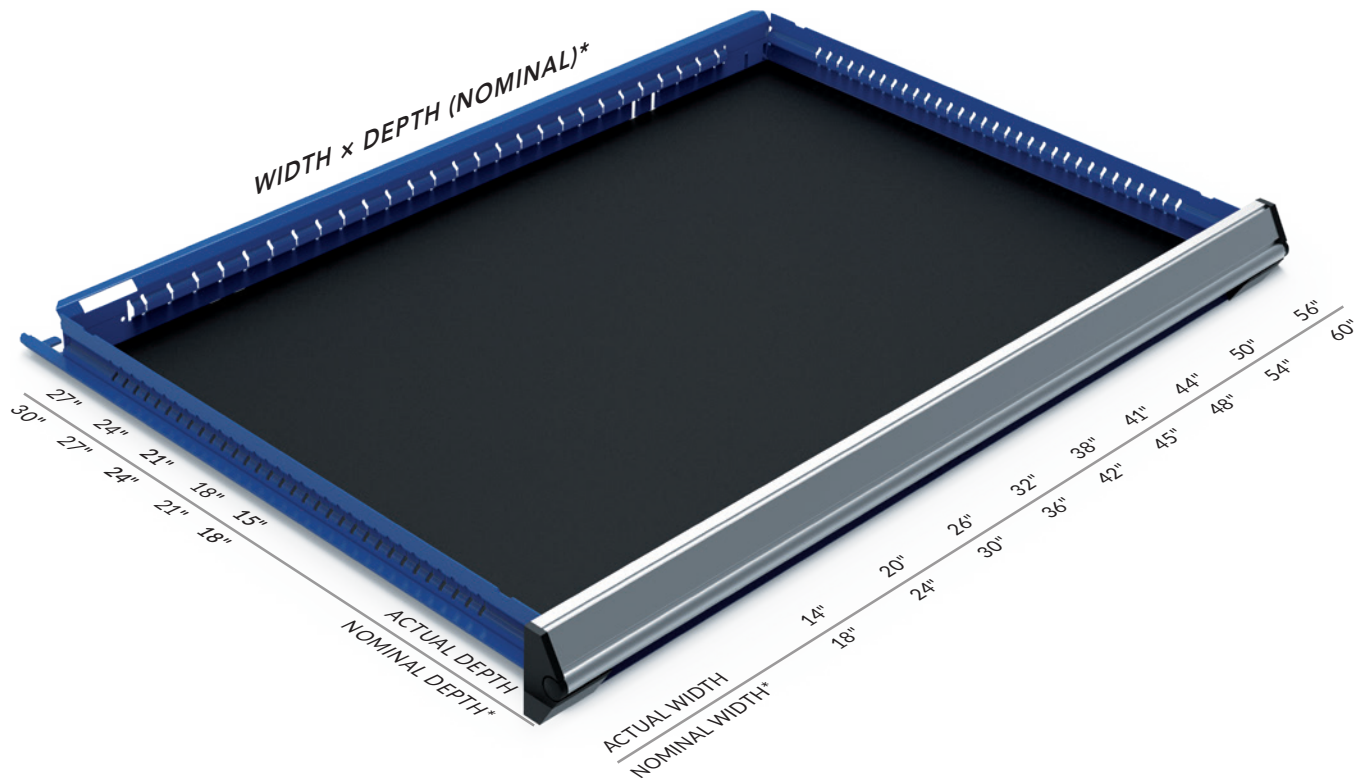

CALCULATE THE DIMENSIONS OF A COMPARTMENT

- Usable width of a drawer: subtract 4½" from the nominal width (e.g., 36"W - 4½"W = 31½"W)
- Usable depth of a drawer: subtract 3½" from the nominal depth (e.g., 18"D - 3½"D = 14½"D)
- Compartments: Usable width is calculated by subtracting ½" from the nominal width of the divider (e.g., for a 5"W divider: 5" - ½" = 4½"). For the usable depth, see the diagram opposite

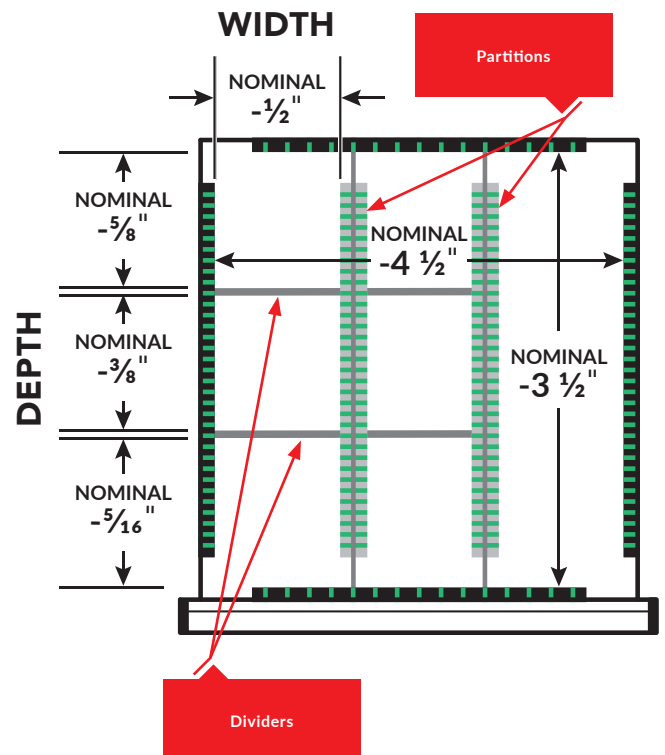
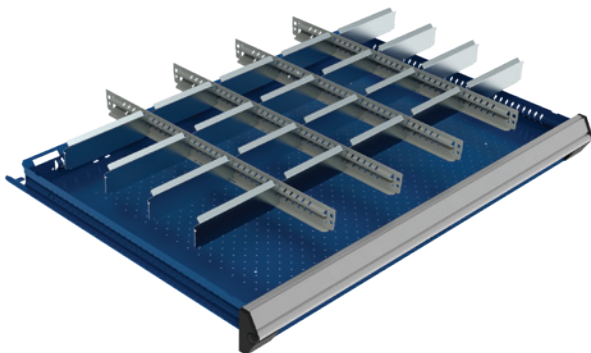

COMPARTMENTS

EXPLANATION OF THE DRAWER DIAGRAMS

- Slots on the drawer sides: green lines
- Slots across the width (left-right): 1" increments. Drawers with an odd-numbered midpoint have extra slots at certain $\frac{1}{2}$ " intervals. The slots start 3" from the left or right edge
- Slots along the depth (top-bottom): $\frac{1}{2}$ " increments. The slots start $2\frac{1}{2}$ " from the front or back edge

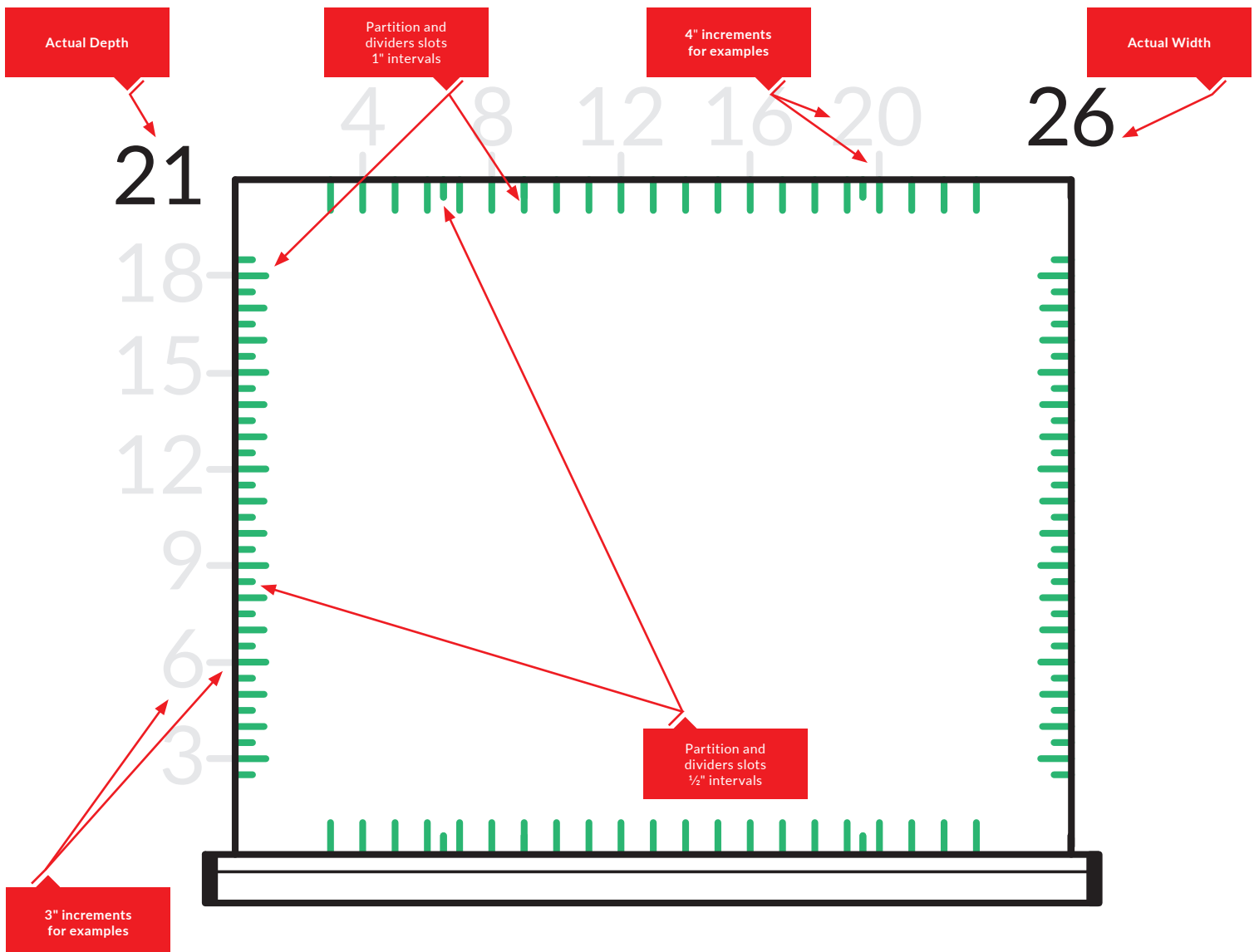

HOW TO USE THIS DOCUMENT

DESIGN AND PRODUCT NUMBERS

EGEND



Depth



Front to Back Partitions RG00



Width



Left to Right Partitions RG01



Height



Dividers RG10

LAYOUT DESIGN

- Print out the page with the desired dimensions
- With a ruler and pencil, draw the layout
- Count the number of partitions and dividers needed for the desired layout and make a note of them in the appropriate spaces

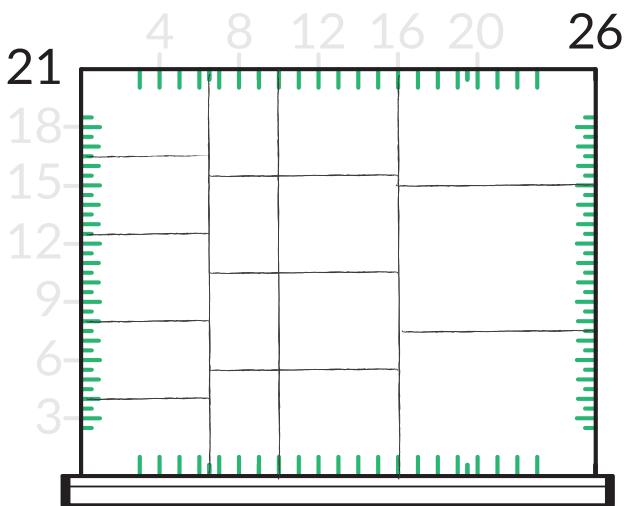

- E.g., a height of 10" is written as 10, a height of 3" is written as 03, see example below. The product number of a front to back partition that is 3" high would be: RG00-2403

FRONT TO BACK PARTITIONS

PRODUCT NO.			QUANTITY
RG00-			
RG00-	24	03	3

DIVIDERS

PRODUCT NO.			QUANTITY
RG10-			
RG10-			
RG10-			
RG10-			
RG10-			
RG10-			

LEFT TO RIGHT PARTITIONS

PRODUCT NO.			QUANTITY
RG01-			
RG01-	30		

DIVIDER NUMBERING SYSTEM - SEE PAGE 39

- Dividers do not have fixed widths, and a layout may need different dimensions, as in the example below
- E.g., the product number for a 6.5"W and 3"H divider will be RG10-06503, and the product number of a 10"W and 3"H divider will be RG10-10003

FRONT TO BACK PARTITIONS

PRODUCT NO.			QUANTITY
RG00-			
RG00-	24	03	3

DIVIDERS

PRODUCT NO.			QUANTITY
RG10-			
RG10-	065	03	4
RG10-	035	03	3
RG10-	060	03	3
RG10-	100	03	2
RG10-			

LEFT TO RIGHT PARTITIONS

PRODUCT NO.			QUANTITY
RG01-			
RG01-	30		

PARTITION NUMBERING SYSTEM - SEE PAGE 38

- Depth: RG00-DDHH, or DD = nominal drawer depth, and HH = nominal partition height
- Width: RG01-WWHH, or WW = nominal drawer width, and HH = nominal partition height
- On each page, the drawer depth (front to back) or width (left to right) is specified in the product number columns
- Add the drawer height and number of partitions needed for your installation

18"W DRAWERS

18" x 21"

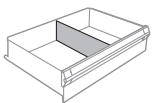
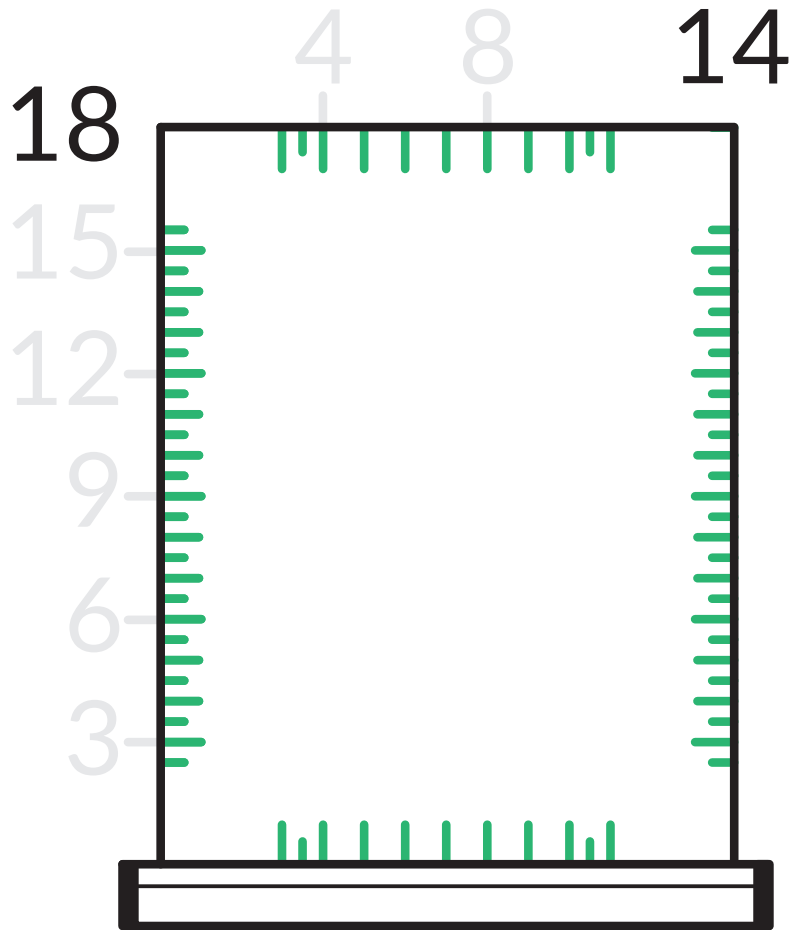

FRONT TO BACK PARTITIONS

	PRODUCT NO.	QUANTITY
RG0X-		
RG00-	21	

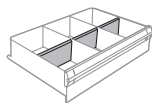

DIVIDERS

	PRODUCT NO.	QUANTITY
RG10-		
RG10-		
RG10-		
RG10-		
RG10-		
RG10-		

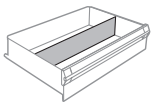

LEFT TO RIGHT PARTITIONS

	PRODUCT NO.	QUANTITY
RG0X-		
RG01-	18	

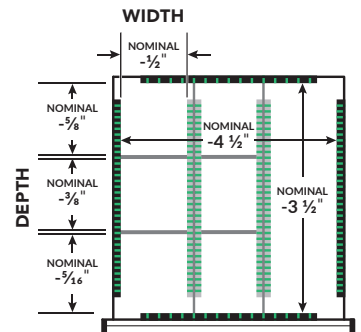
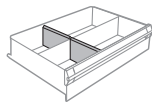

18"W DRAWERS

18" x 24"

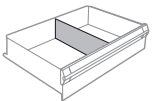
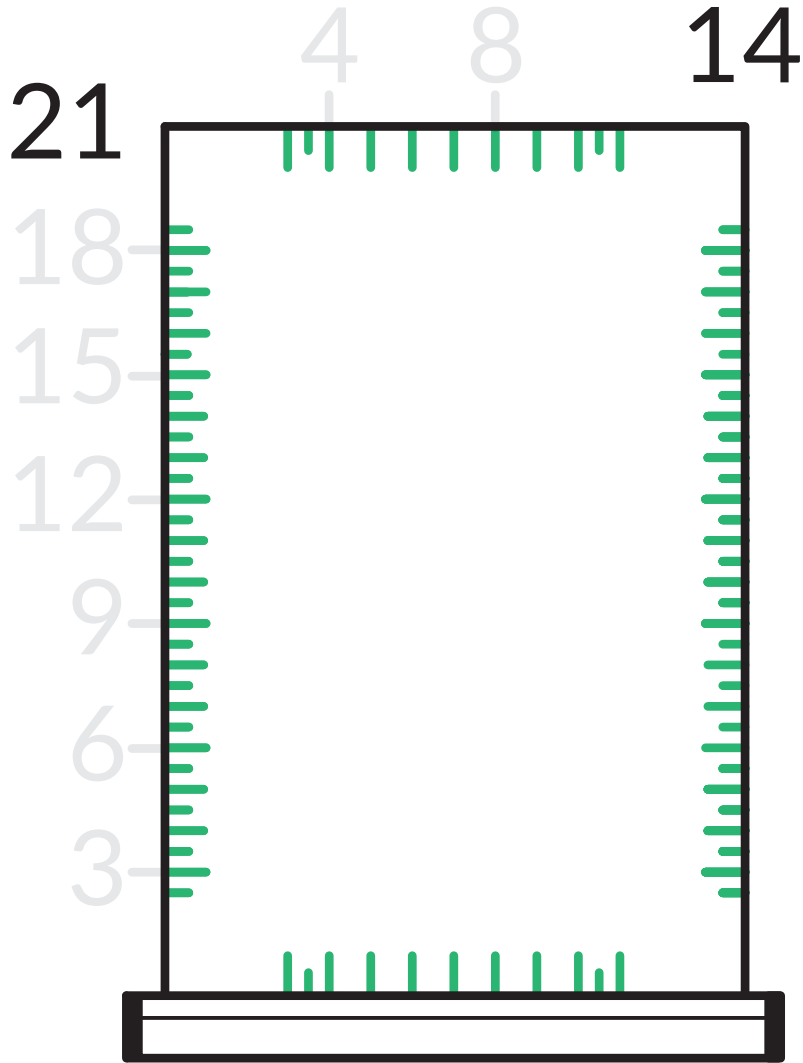

FRONT TO BACK PARTITIONS

	PRODUCT NO.	QUANTITY
RG0X-		
RG00-	24	

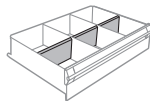

DIVIDERS

	PRODUCT NO.	QUANTITY
RG10-		
RG10-		
RG10-		
RG10-		
RG10-		
RG10-		

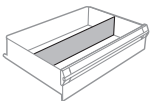

LEFT TO RIGHT PARTITIONS

	PRODUCT NO.	QUANTITY
RG0X-		
RG01-	18	

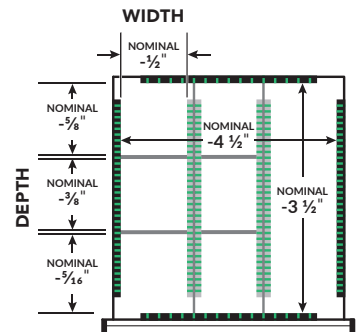
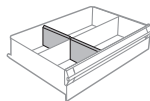

18"W DRAWERS

18" x 27"

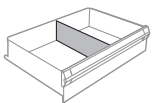
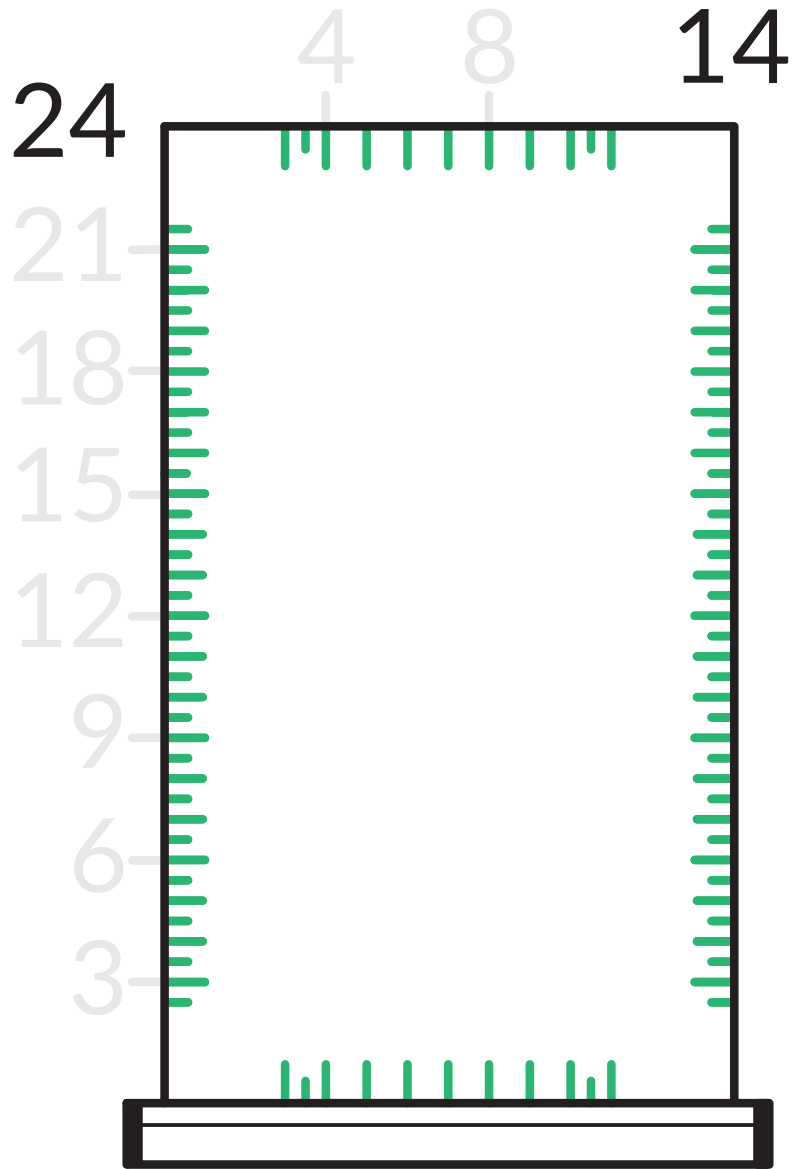

FRONT TO BACK PARTITIONS

	PRODUCT NO.	QUANTITY
	RG0X-	
	RG00-	27

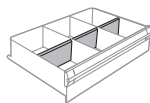

LEFT TO RIGHT PARTITIONS

	PRODUCT NO.	QUANTITY
	RG0X-	
	RG01-	18

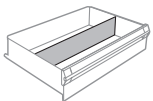

DIVIDERS

	PRODUCT NO.	QUANTITY
	RG10-	
	RG10-	
	RG10-	
	RG10-	
	RG10-	
	RG10-	

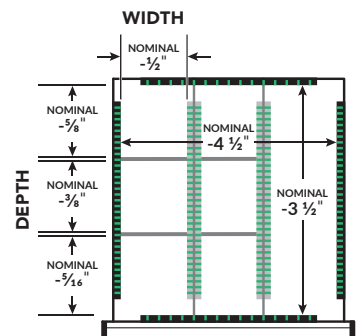

24"W DRAWERS

24" x 18"



NON-STANDARD DIMENSIONS, CONTACT YOUR CUSTOMER SERVICE REPRESENTATIVE

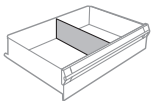
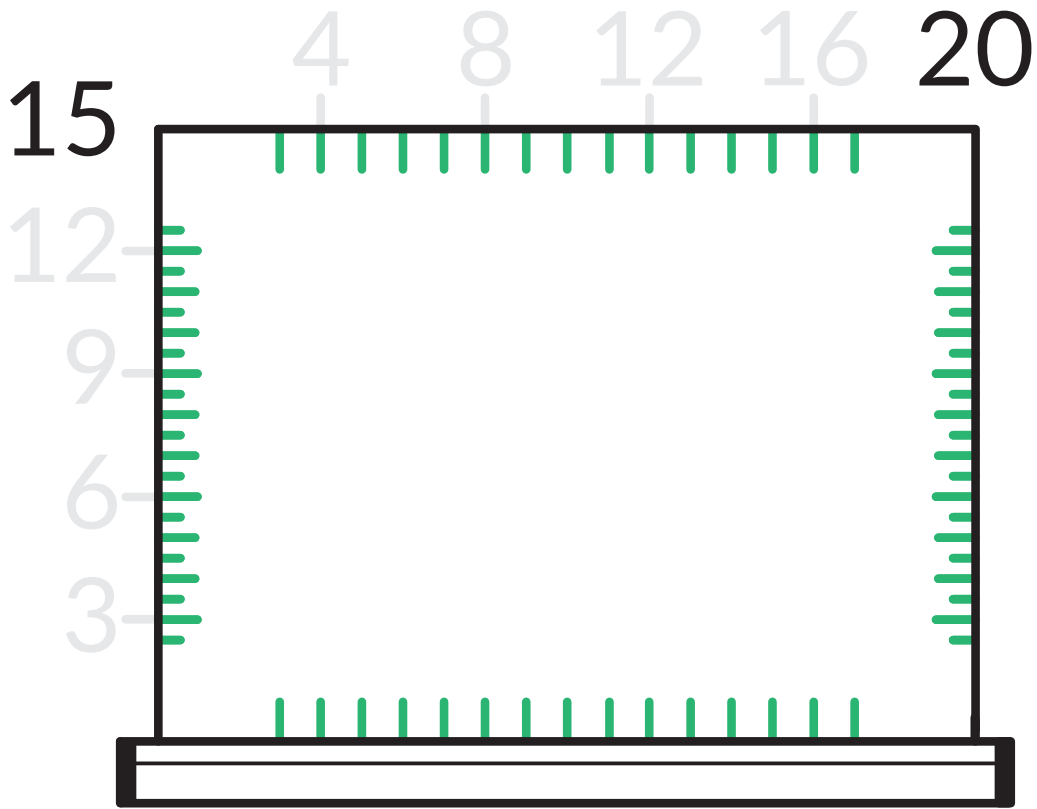

FRONT TO BACK PARTITIONS

	PRODUCT NO.	QUANTITY
	RG0X-	
	RG00- 18	

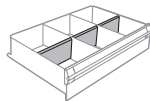

DIVIDERS

	PRODUCT NO.	QUANTITY
	RG10-	
	RG10-	
	RG10-	
	RG10-	
	RG10-	
	RG10-	
	RG10-	
	RG10-	

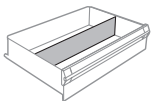

LEFT TO RIGHT PARTITIONS

	PRODUCT NO.	QUANTITY
	RG0X-	
	RG01- 24	

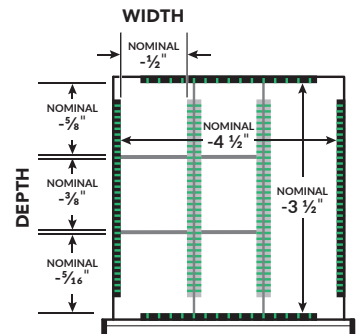
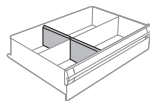

24"W DRAWERS

24" x 21"

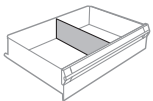
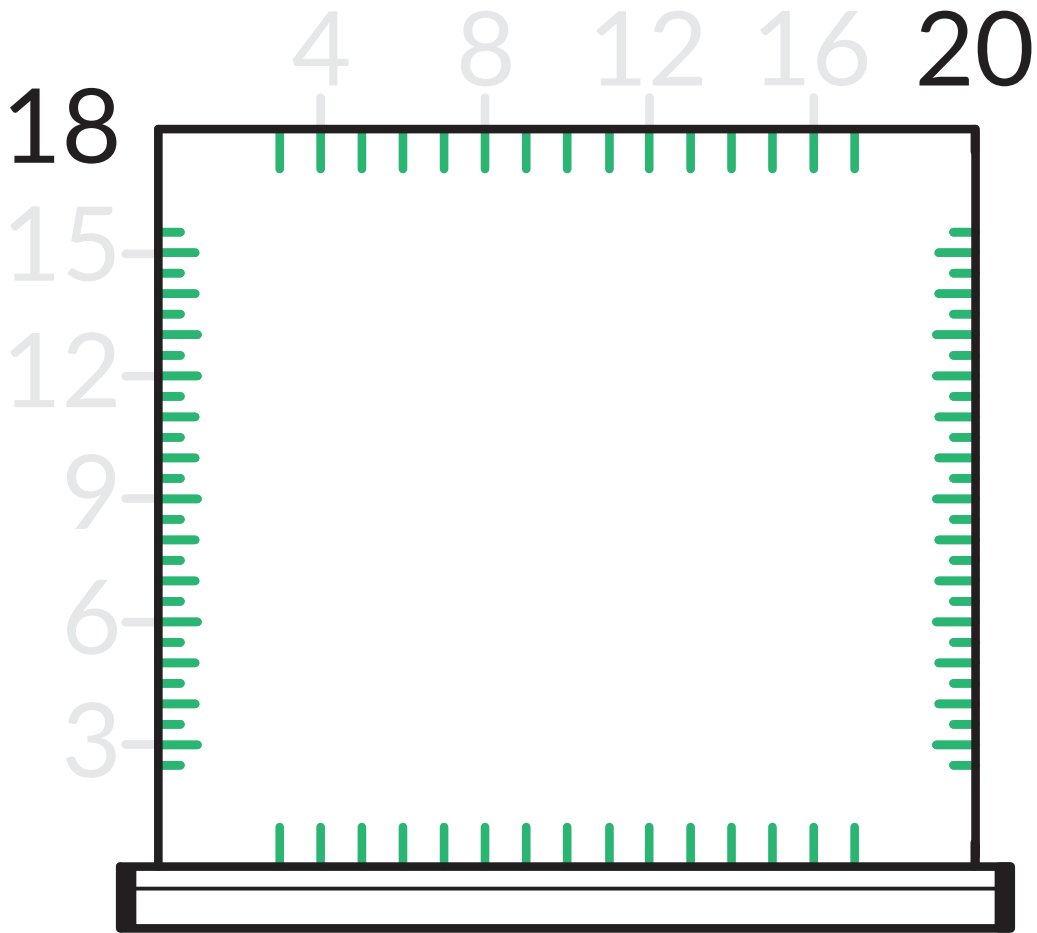

FRONT TO BACK PARTITIONS

	PRODUCT NO.	QUANTITY
RG0X-		<input type="checkbox"/>
RG00-	21	<input type="checkbox"/>

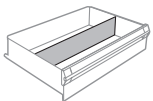
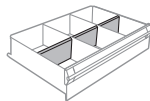

LEFT TO RIGHT PARTITIONS

	PRODUCT NO.	QUANTITY
RG0X-		<input type="checkbox"/>
RG01-	24	<input type="checkbox"/>

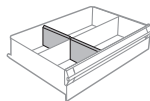

DIVIDERS

	PRODUCT NO.	QUANTITY
RG10-		<input type="checkbox"/>
RG10-		<input type="checkbox"/>
RG10-		<input type="checkbox"/>
RG10-		<input type="checkbox"/>
RG10-		<input type="checkbox"/>
RG10-		<input type="checkbox"/>

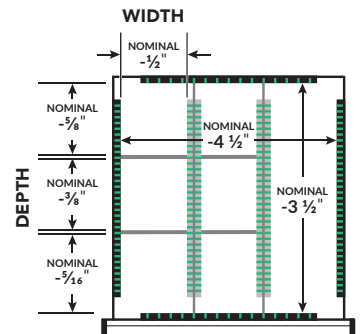

24"W DRAWERS

24" x 24"

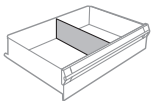
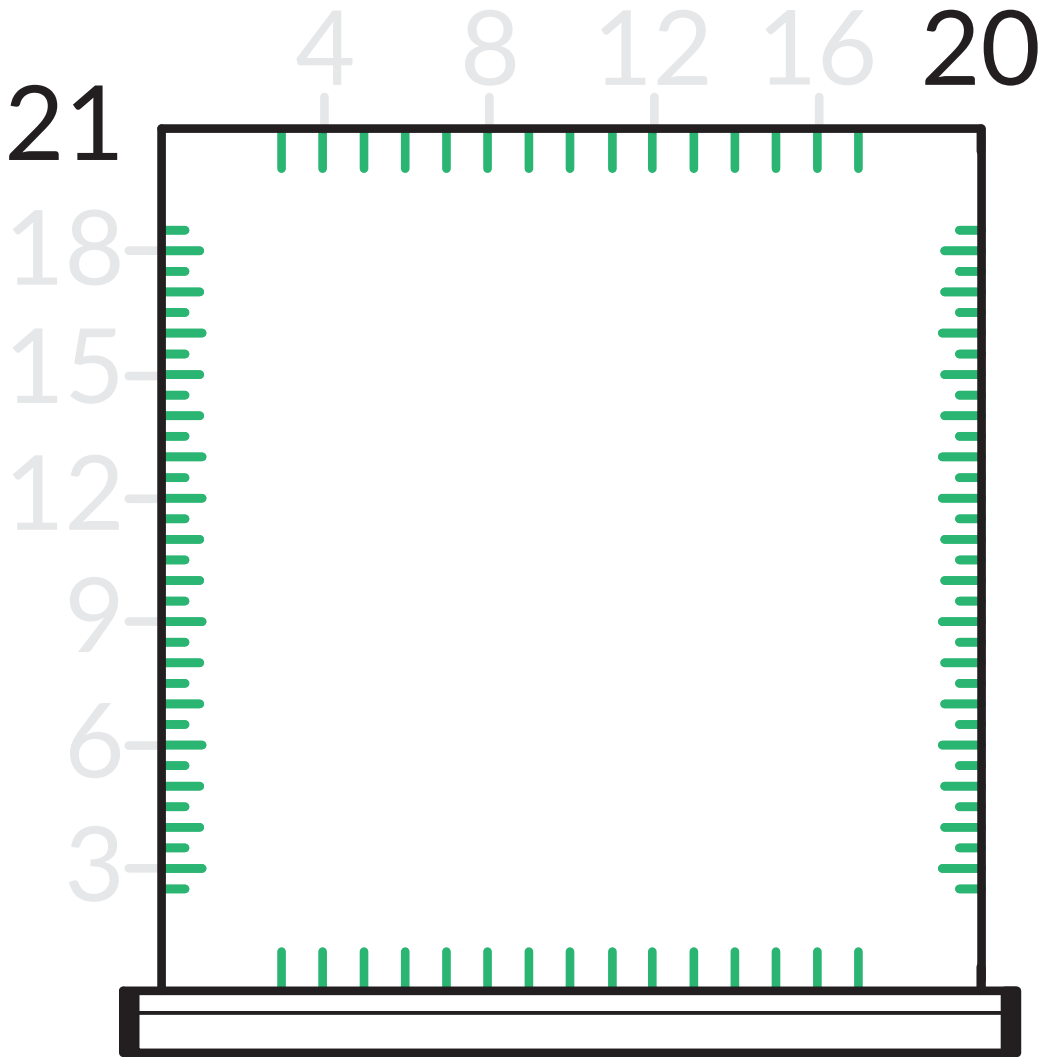

FRONT TO BACK PARTITIONS

PRODUCT NO.	QUANTITY
RG0X-	
RG00- 24	

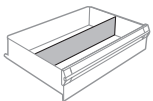
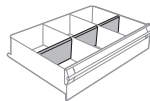

LEFT TO RIGHT PARTITIONS

PRODUCT NO.	QUANTITY
RG0X-	
RG01- 24	

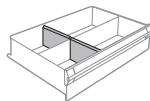

DIVIDERS

PRODUCT NO.	QUANTITY
RG10-	
RG10-	
RG10-	
RG10-	
RG10-	
RG10-	

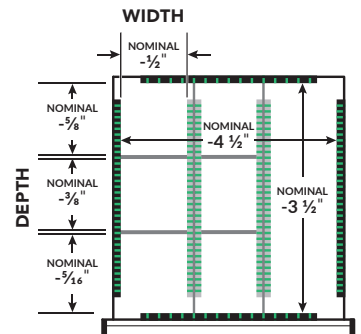

24"W DRAWERS

24" x 27"

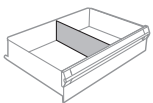
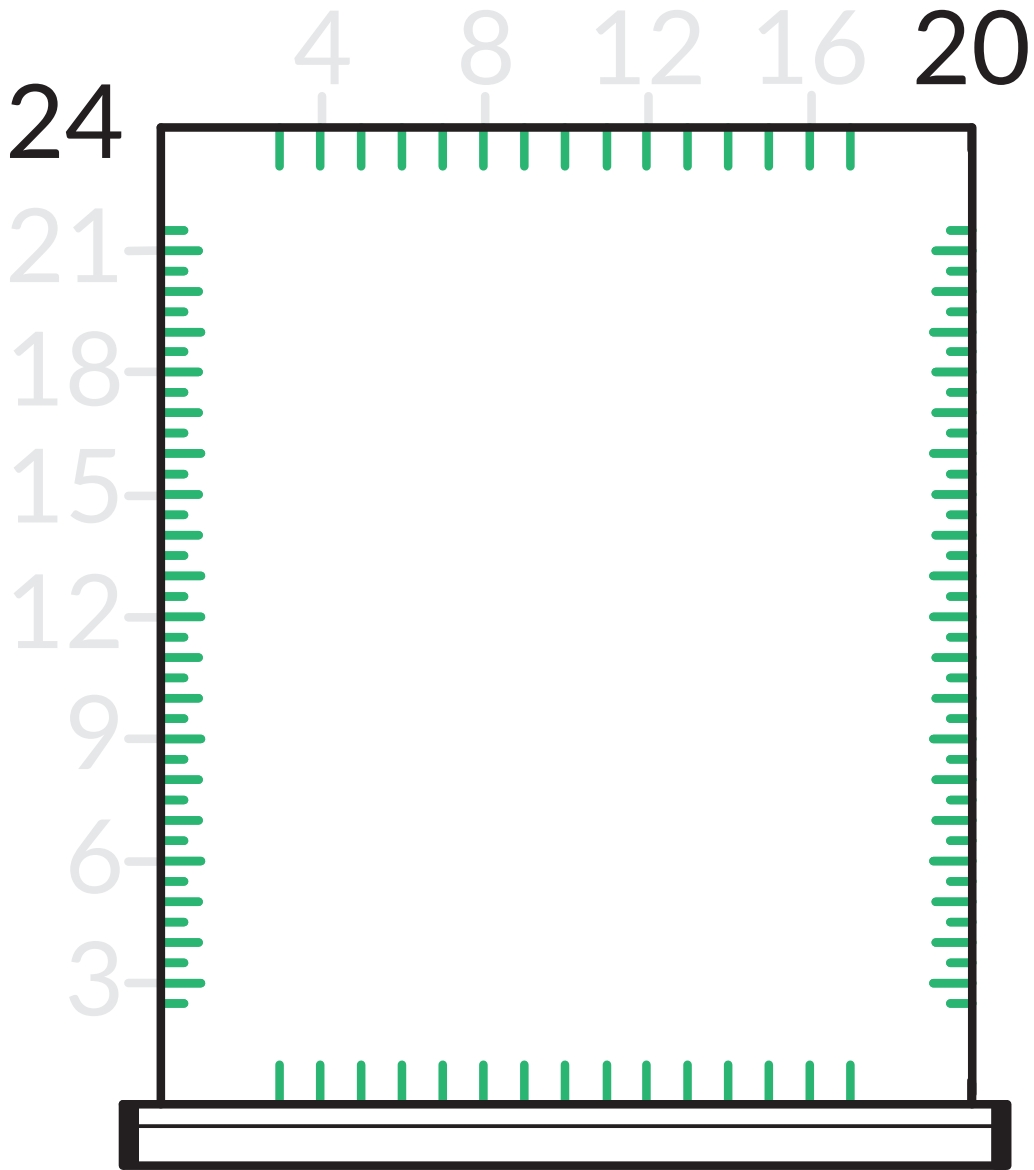

FRONT TO BACK PARTITIONS

	PRODUCT NO.	QUANTITY
RG0X-		
RG00-	27	

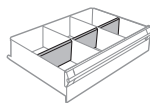

DIVIDERS

	PRODUCT NO.	QUANTITY
RG10-		
RG10-		
RG10-		
RG10-		
RG10-		
RG10-		

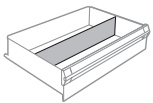

LEFT TO RIGHT PARTITIONS

	PRODUCT NO.	QUANTITY
RG0X-		
RG01-	24	

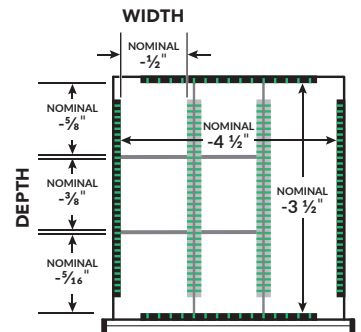
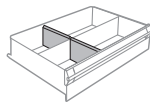

30"W DRAWERS

30" x 18"

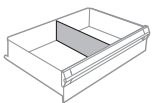
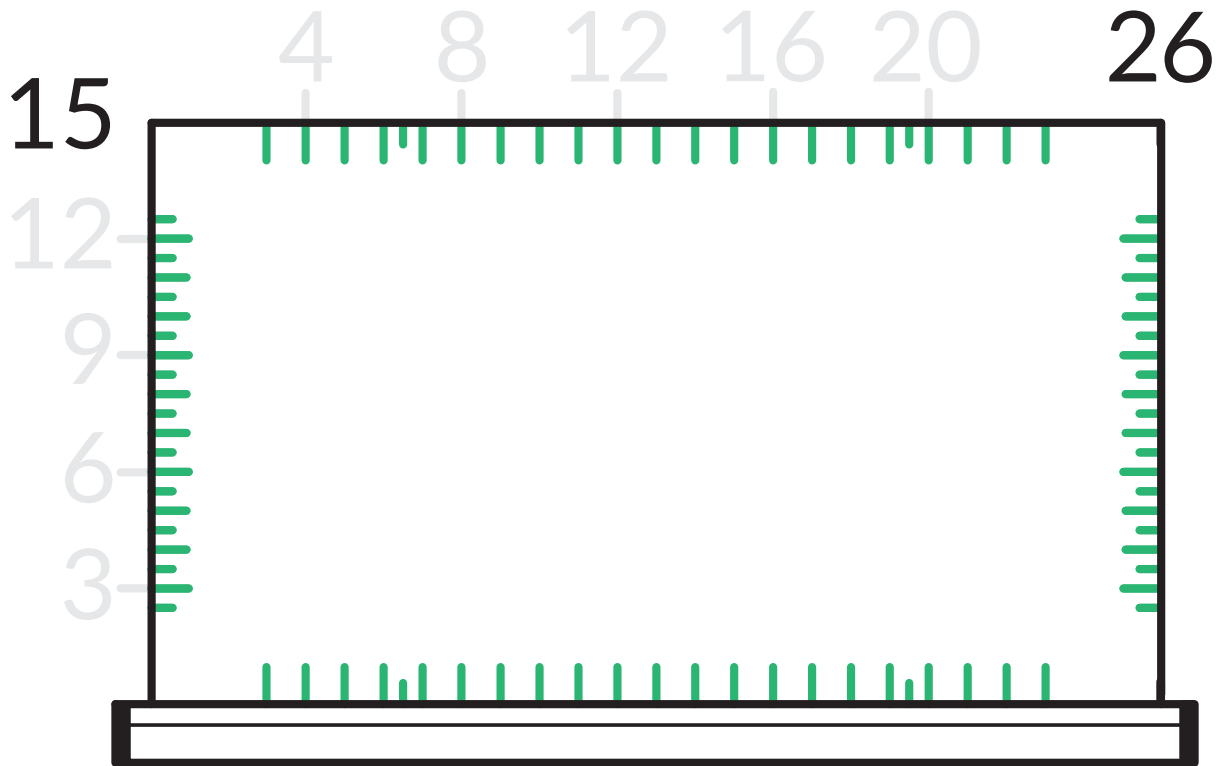

FRONT TO BACK PARTITIONS

	PRODUCT NO.	QUANTITY
RG0X-		
RG00-	18	

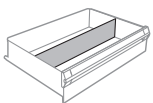
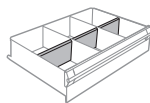

LEFT TO RIGHT PARTITIONS

	PRODUCT NO.	QUANTITY
RG0X-		
RG01-	30	

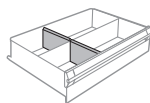

DIVIDERS

	PRODUCT NO.	QUANTITY
RG10-		
RG10-		
RG10-		
RG10-		
RG10-		
RG10-		

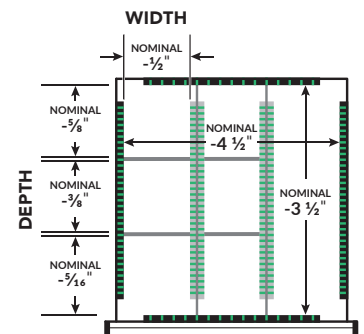

30"W DRAWERS

30" x 21"

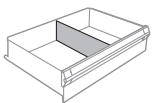
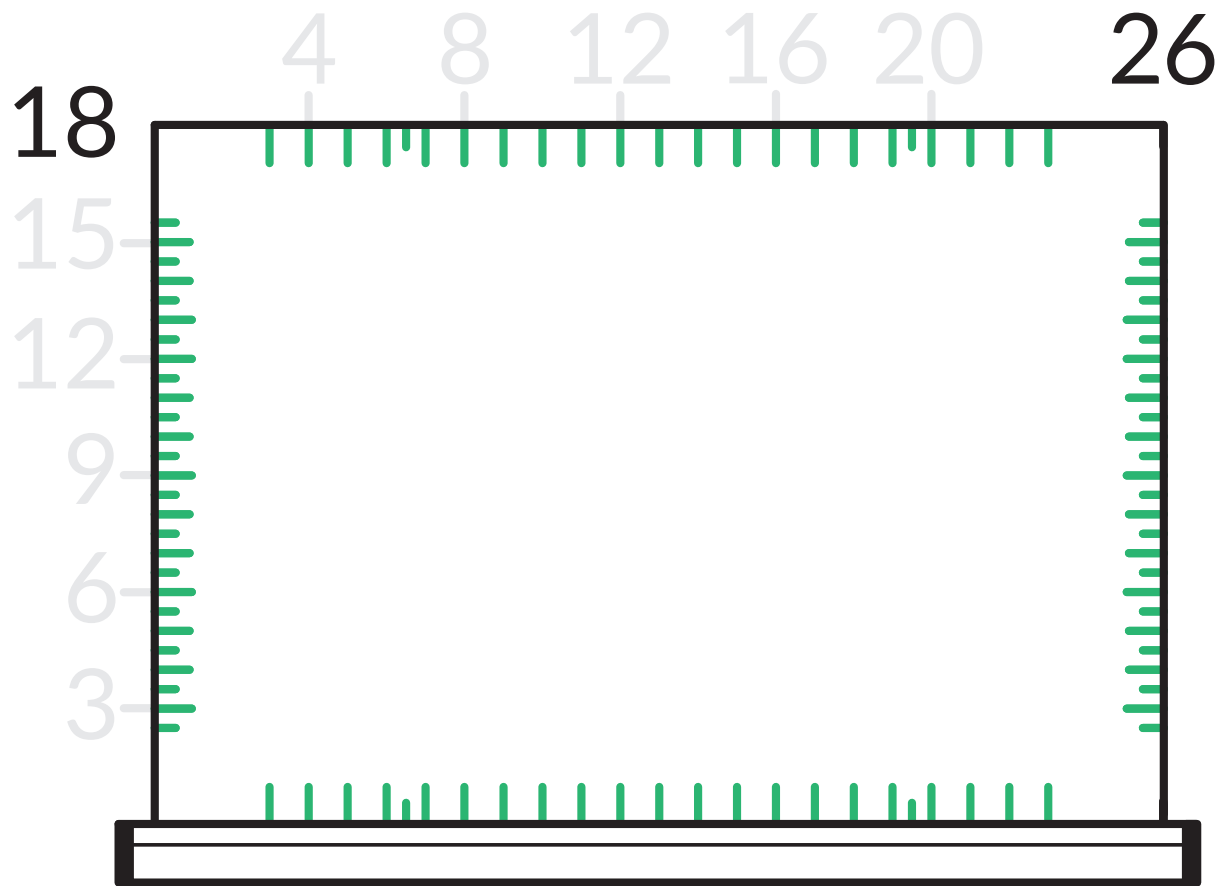

FRONT TO BACK PARTITIONS

	PRODUCT NO.	QUANTITY
RG0X-		
RG00-	21	

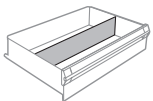
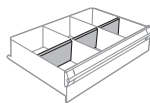

LEFT TO RIGHT PARTITIONS

	PRODUCT NO.	QUANTITY
RG0X-		
RG01-	30	

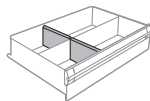

DIVIDERS

	PRODUCT NO.	QUANTITY
RG10-		
RG10-		
RG10-		
RG10-		
RG10-		
RG10-		

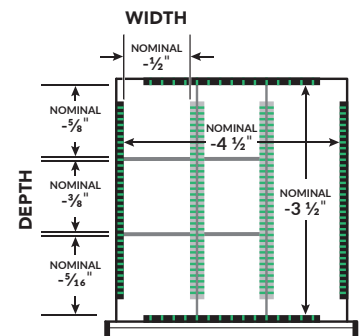

30"W DRAWERS

30" x 24"

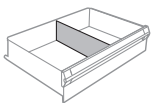
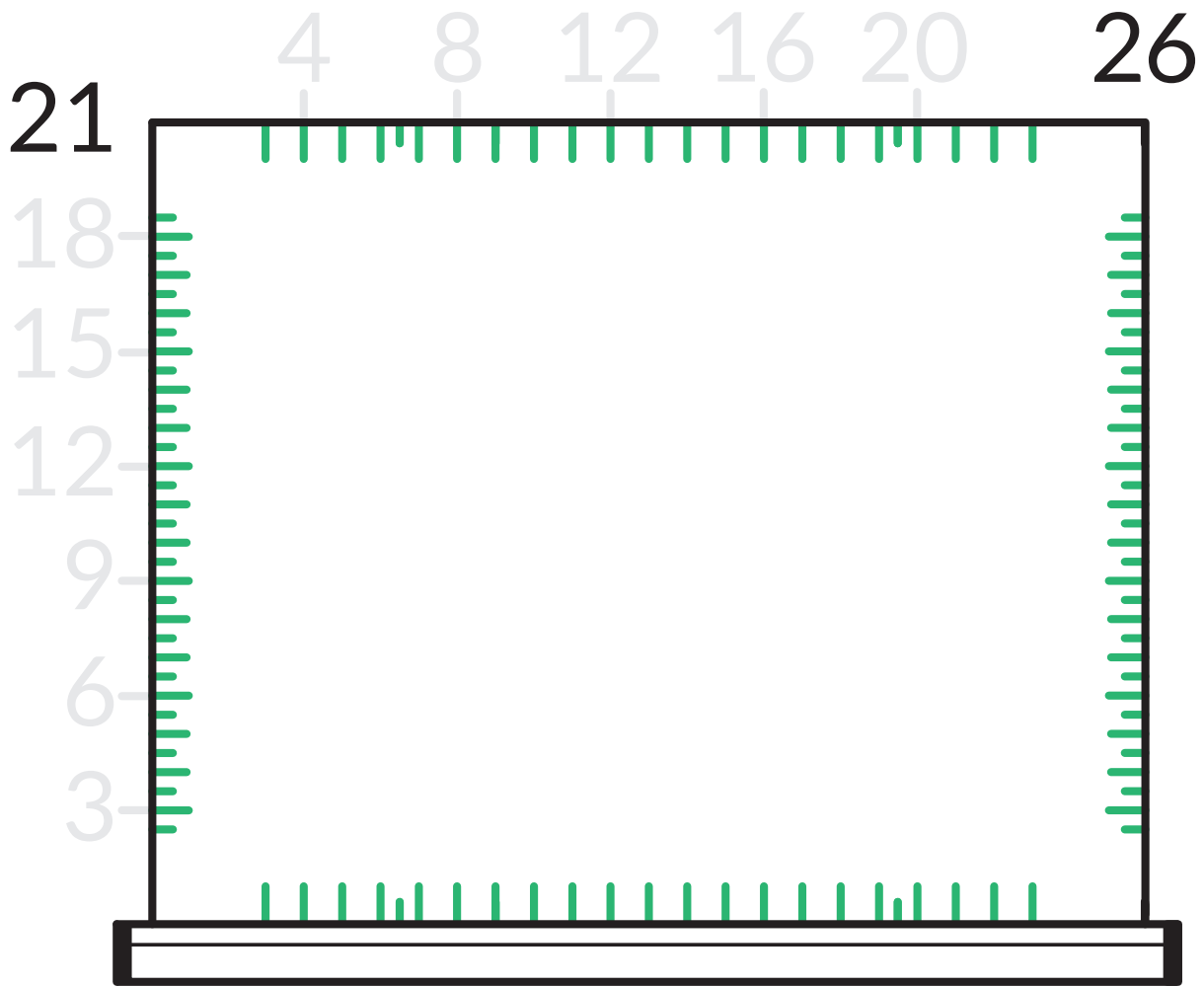

FRONT TO BACK PARTITIONS

PRODUCT NO.	QUANTITY
RG0X-	
RG00- 24	

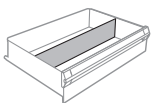
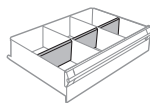

LEFT TO RIGHT PARTITIONS

PRODUCT NO.	QUANTITY
RG0X-	
RG01- 30	

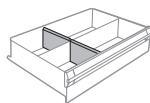

DIVIDERS

PRODUCT NO.	QUANTITY
RG10-	
RG10-	
RG10-	
RG10-	
RG10-	
RG10-	

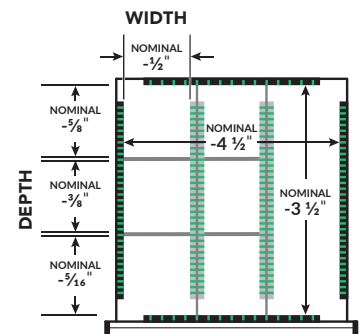

30"W DRAWERS

30" x 27"

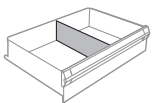
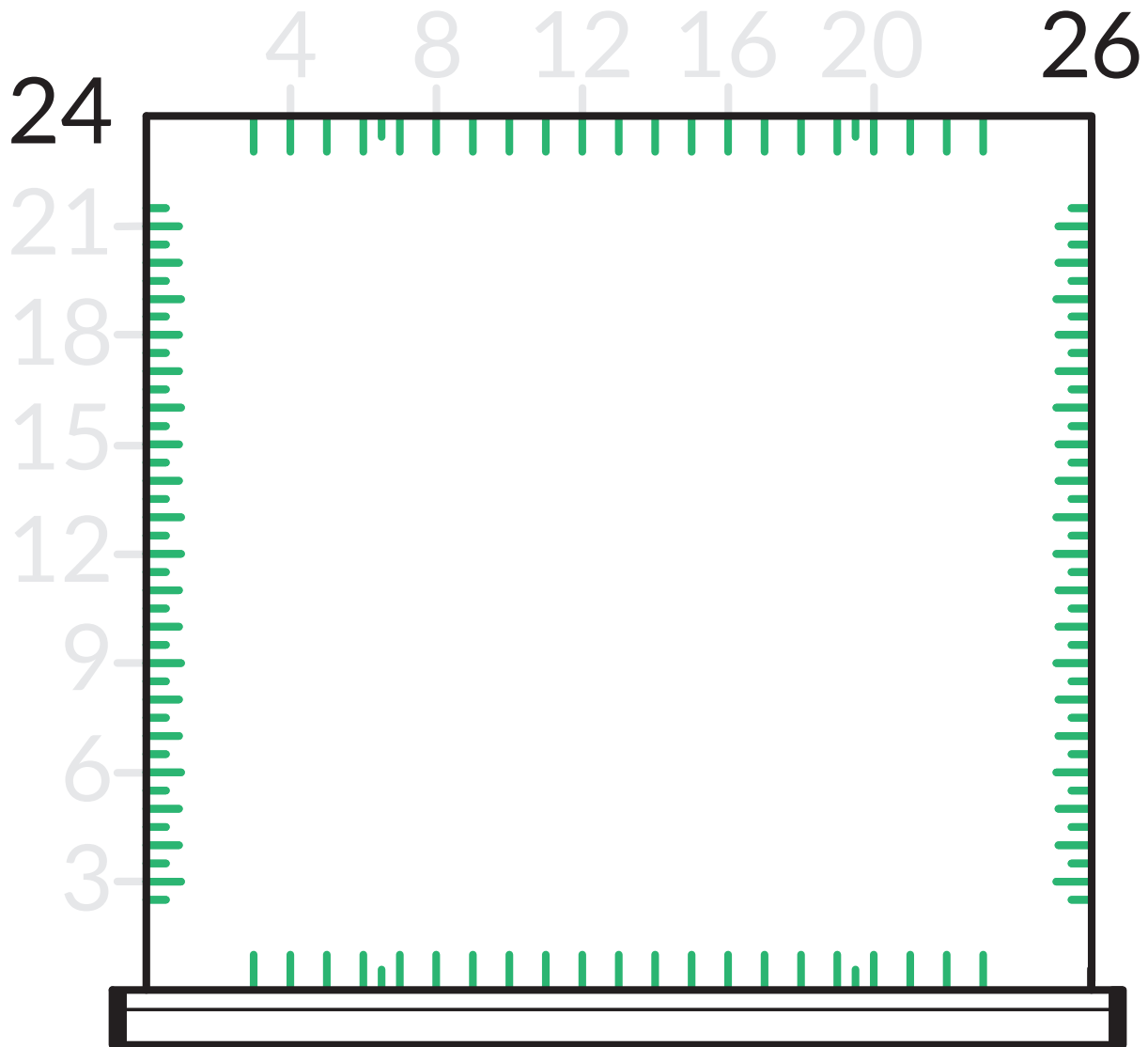

FRONT TO BACK PARTITIONS

PRODUCT NO.	QUANTITY
RG0X-	
RG00- 27	

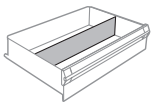
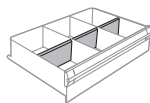

LEFT TO RIGHT PARTITIONS

PRODUCT NO.	QUANTITY
RG0X-	
RG01- 30	

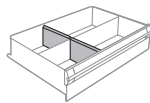

DIVIDERS

PRODUCT NO.	QUANTITY
RG10-	
RG10-	
RG10-	
RG10-	
RG10-	
RG10-	

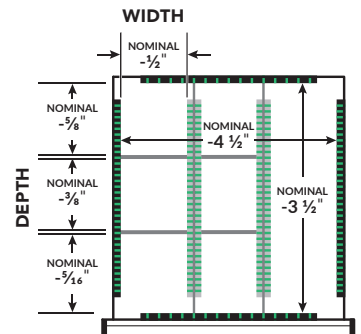

36"W DRAWERS

36" x 18"

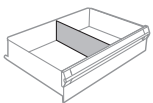
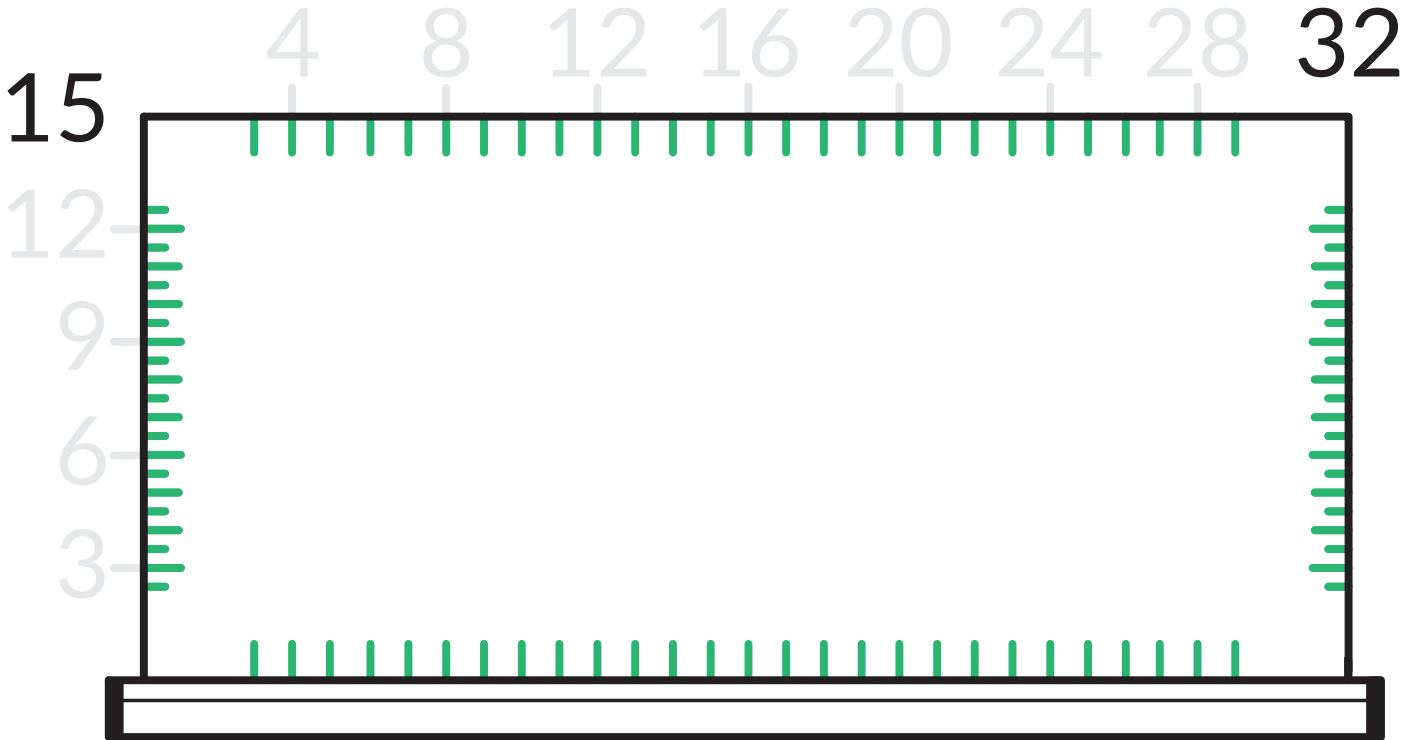

FRONT TO BACK PARTITIONS

	PRODUCT NO.	QUANTITY
RG0X-		
RG00-	18	

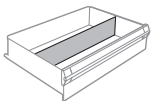
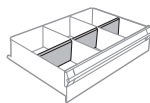

LEFT TO RIGHT PARTITIONS

	PRODUCT NO.	QUANTITY
RG0X-		
RG01-	36	

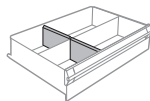

DIVIDERS

	PRODUCT NO.	QUANTITY
RG10-		
RG10-		
RG10-		
RG10-		
RG10-		
RG10-		

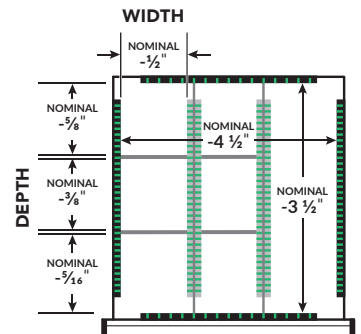

36"W DRAWERS



NON-STANDARD DIMENSIONS, CONTACT YOUR CUSTOMER SERVICE REPRESENTATIVE

36" x 21"

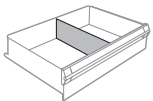
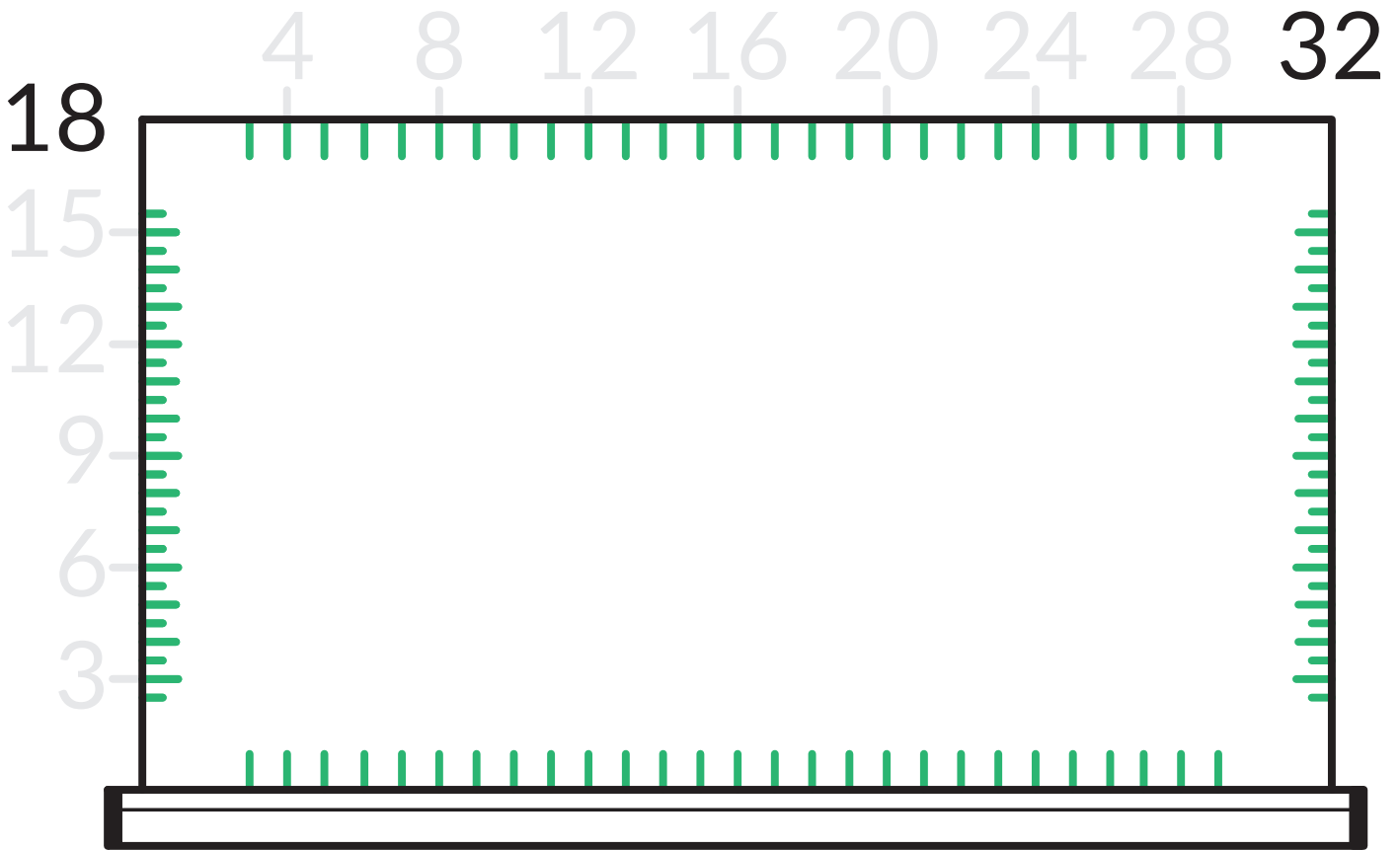

FRONT TO BACK PARTITIONS

	PRODUCT NO.	QUANTITY
RG0X-		
RG00-	21	

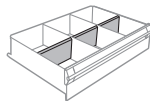

DIVIDERS

	PRODUCT NO.	QUANTITY
RG10-		
RG10-		
RG10-		
RG10-		
RG10-		
RG10-		

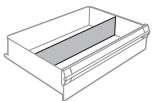

LEFT TO RIGHT PARTITIONS

	PRODUCT NO.	QUANTITY
RG0X-		
RG01-	36	

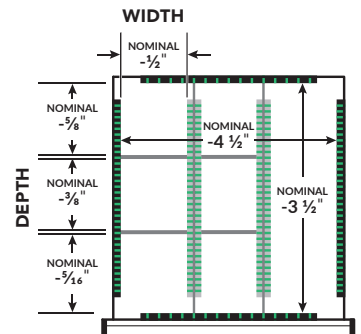
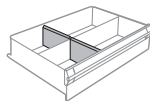

36"W DRAWERS

36" x 24"

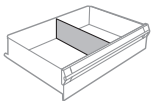
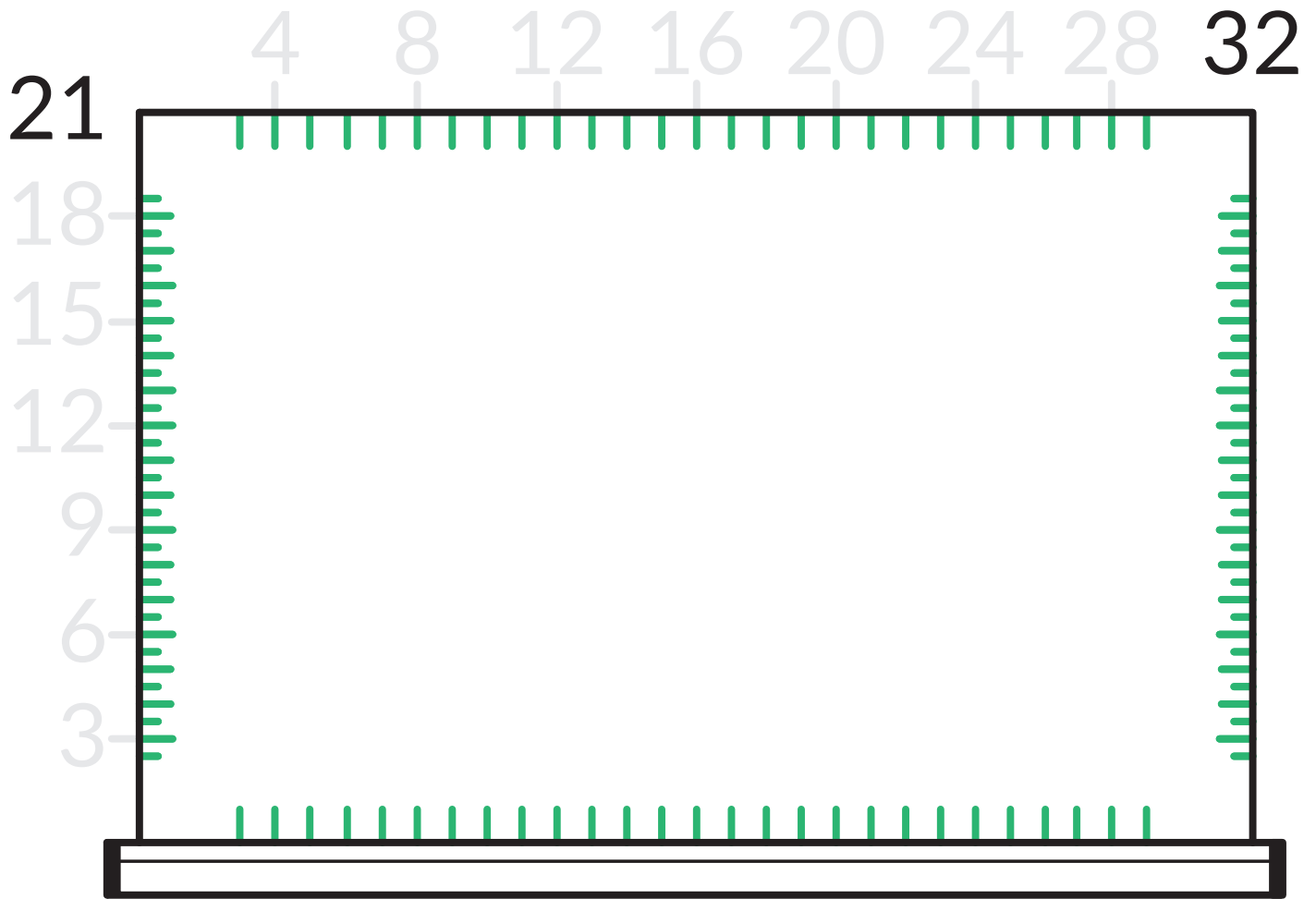

FRONT TO BACK PARTITIONS

	PRODUCT NO.	QUANTITY
RG0X-		<input type="checkbox"/>
RG00-	24	<input type="checkbox"/>

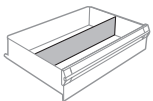
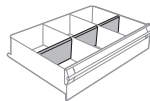

LEFT TO RIGHT PARTITIONS

	PRODUCT NO.	QUANTITY
RG0X-		<input type="checkbox"/>
RG01-	36	<input type="checkbox"/>

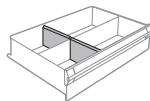

DIVIDERS

	PRODUCT NO.	QUANTITY
RG10-		<input type="checkbox"/>
RG10-		<input type="checkbox"/>
RG10-		<input type="checkbox"/>
RG10-		<input type="checkbox"/>
RG10-		<input type="checkbox"/>
RG10-		<input type="checkbox"/>

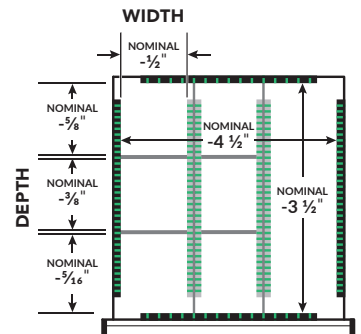

36"W DRAWERS

36" x 27"

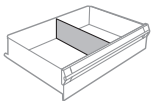
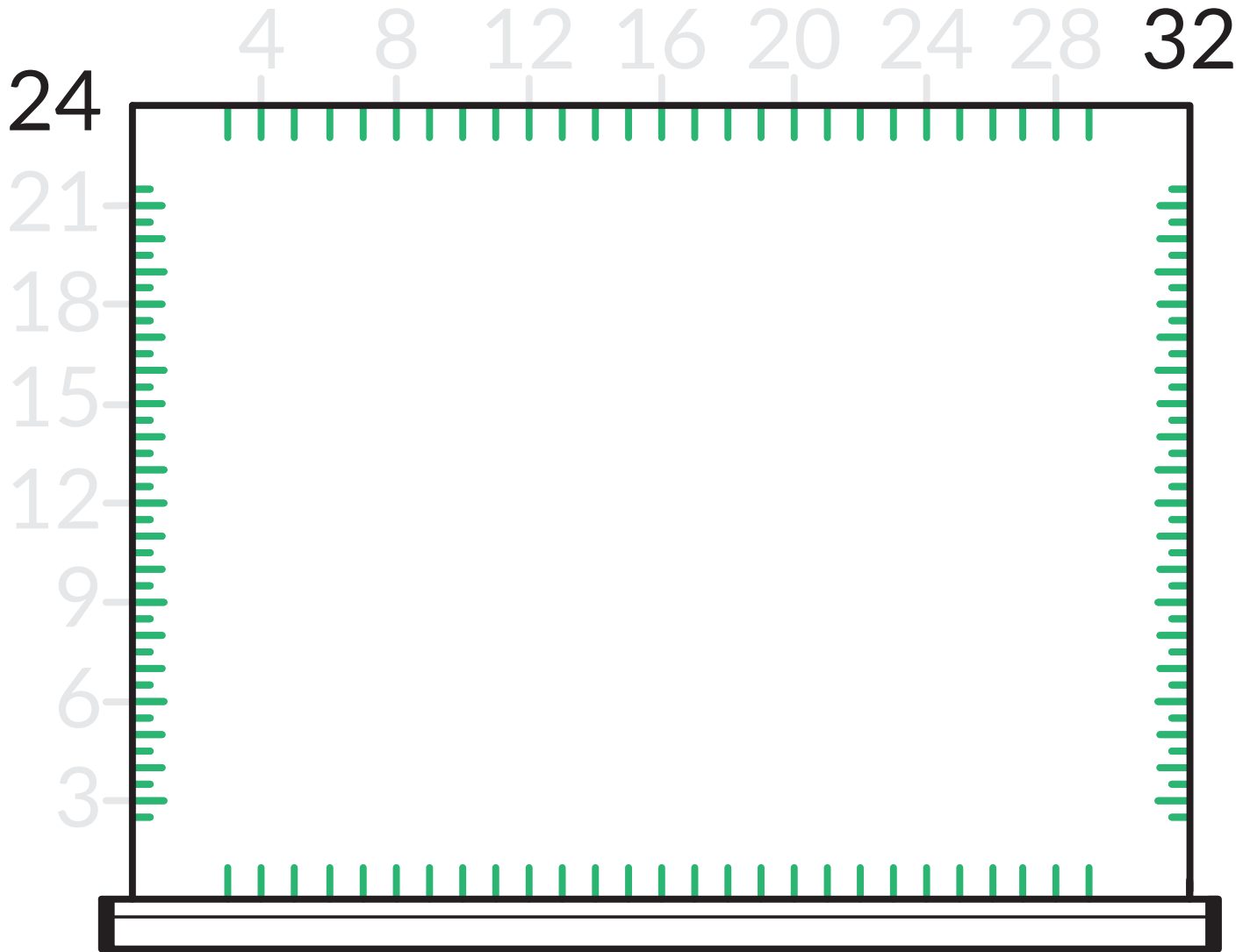

FRONT TO BACK PARTITIONS

	PRODUCT NO.	QUANTITY
RG0X-		
RG00-	27	

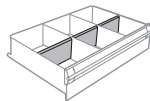

LEFT TO RIGHT PARTITIONS

	PRODUCT NO.	QUANTITY
RG0X-		
RG01-	36	

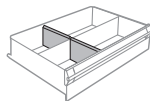

DIVIDERS

	PRODUCT NO.	QUANTITY
RG10-		
RG10-		
RG10-		
RG10-		
RG10-		
RG10-		

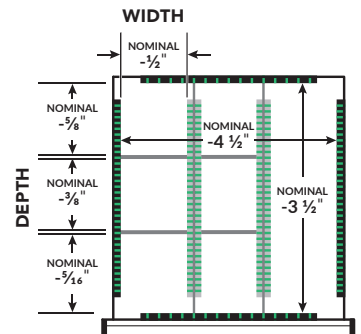

36"W DRAWERS



NON-STANDARD DIMENSIONS, CONTACT YOUR CUSTOMER SERVICE REPRESENTATIVE

36" x 30"

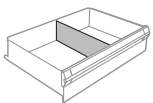
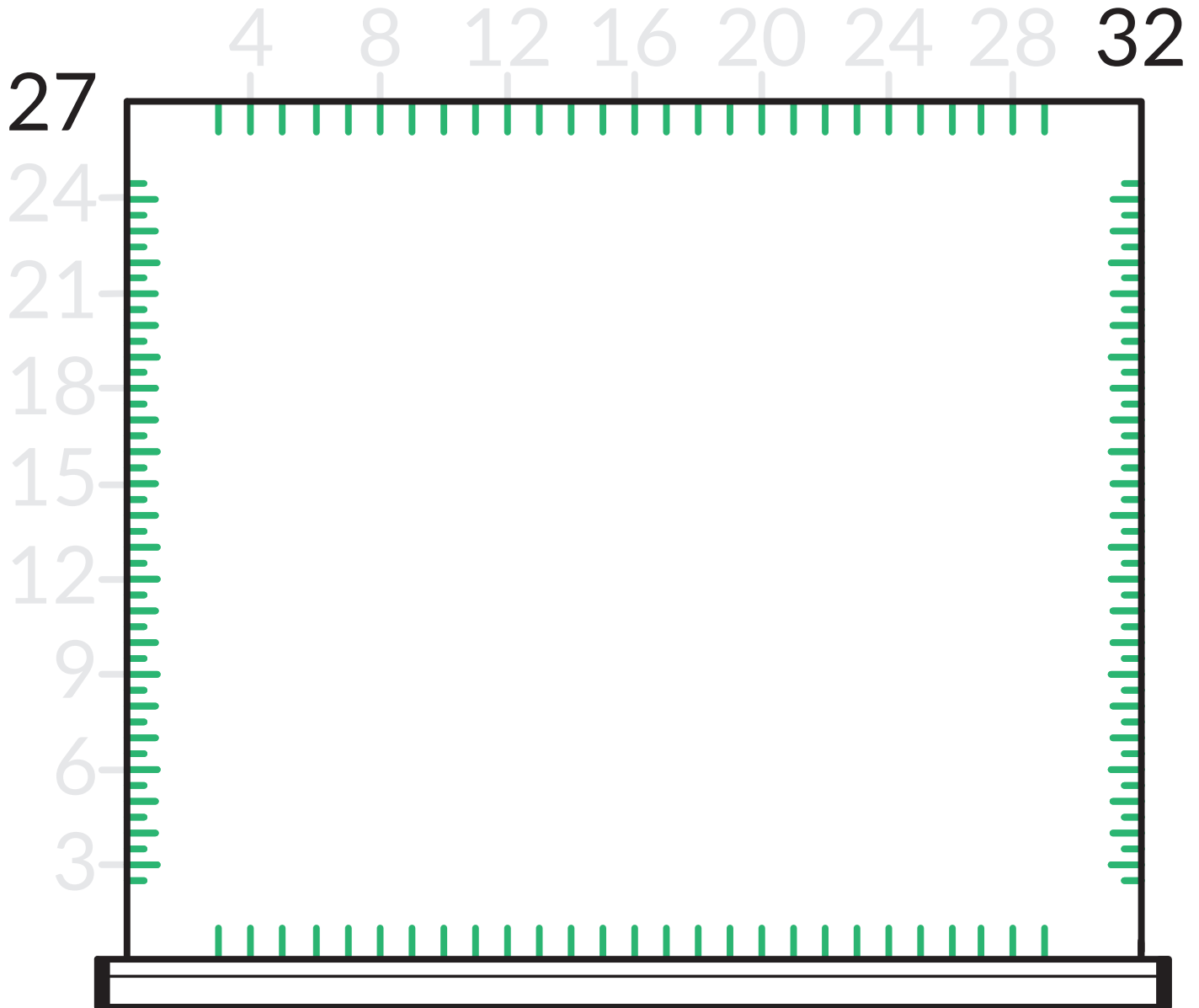

FRONT TO BACK PARTITIONS

	PRODUCT NO.	QUANTITY
RG0X-		
RG00-	30	

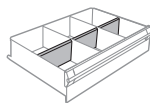

DIVIDERS

	PRODUCT NO.	QUANTITY
RG10-		
RG10-		
RG10-		
RG10-		
RG10-		
RG10-		

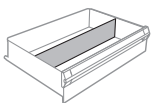

LEFT TO RIGHT PARTITIONS

	PRODUCT NO.	QUANTITY
RG0X-		
RG01-	36	

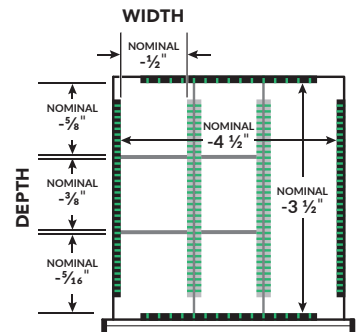
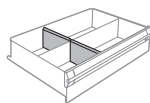

42"W DRAWERS

42" x 18"

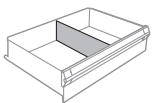
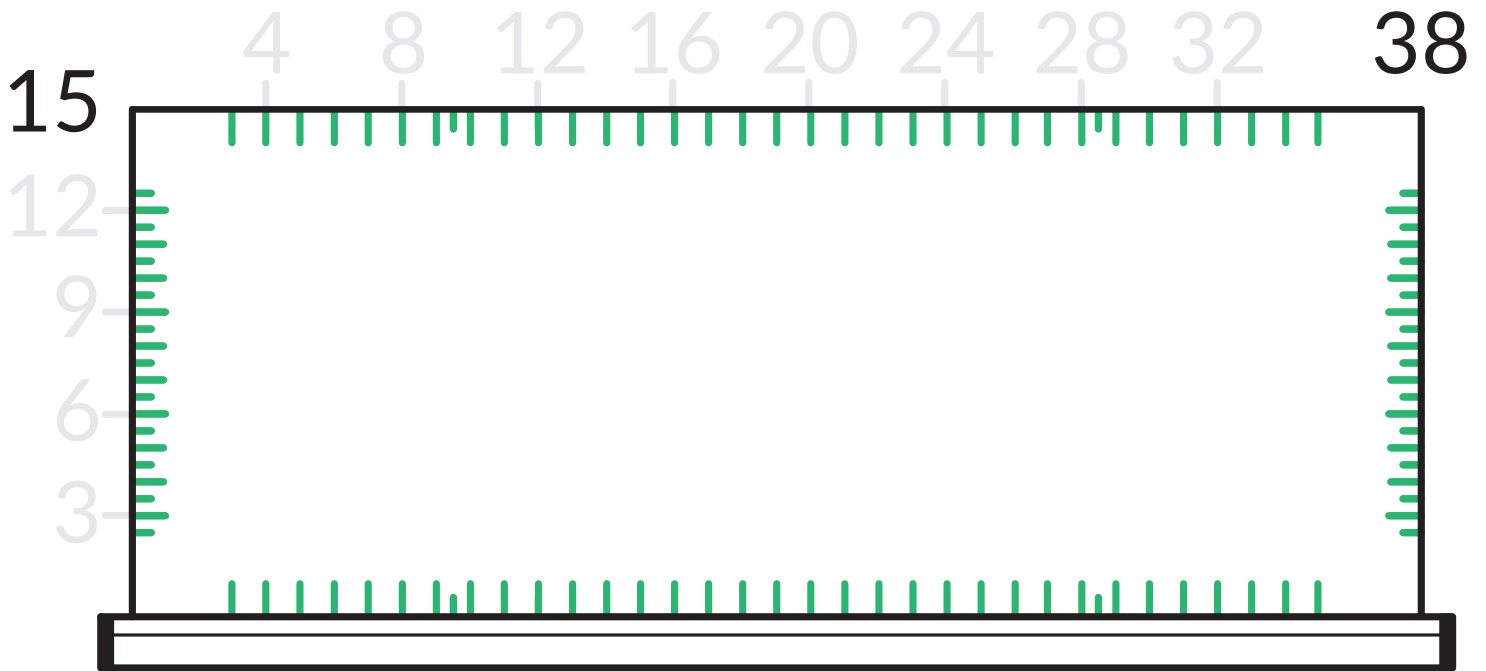

FRONT TO BACK PARTITIONS

	PRODUCT NO.	QUANTITY
RG0X-		
RG00-	18	

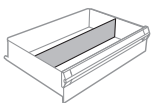
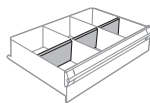

LEFT TO RIGHT PARTITIONS

	PRODUCT NO.	QUANTITY
RG0X-		
RG01-	42	

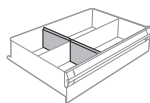

DIVIDERS

	PRODUCT NO.	QUANTITY
RG10-		
RG10-		
RG10-		
RG10-		
RG10-		
RG10-		

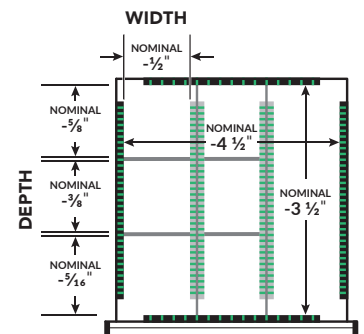

42"W DRAWERS



NON-STANDARD DIMENSIONS, CONTACT YOUR CUSTOMER SERVICE REPRESENTATIVE

42" x 21"

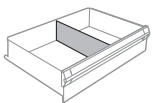
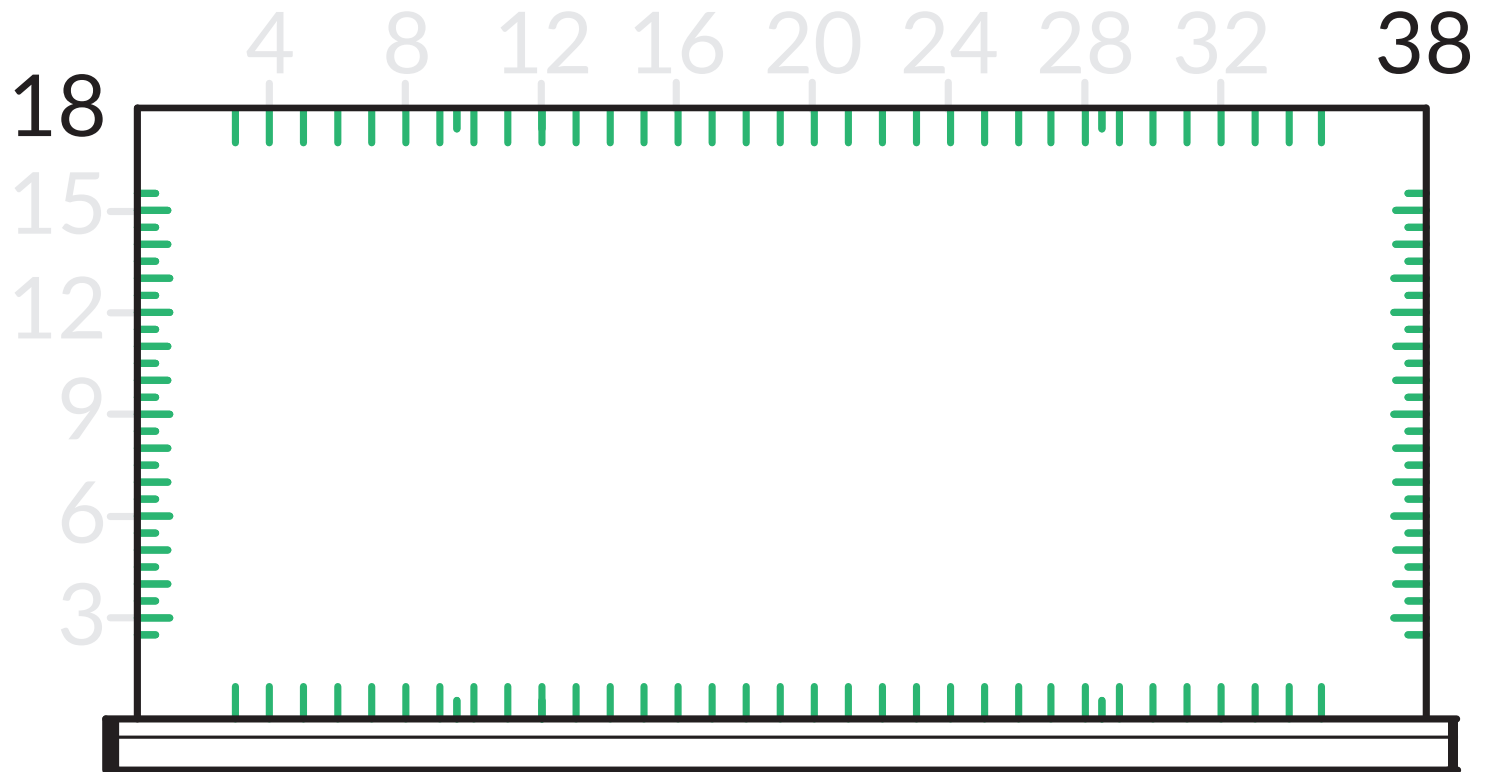

FRONT TO BACK PARTITIONS

	PRODUCT NO.	QUANTITY
RG0X-		
RG00-	21	

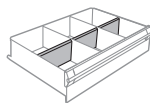

DIVIDERS

	PRODUCT NO.	QUANTITY
RG10-		
RG10-		
RG10-		
RG10-		
RG10-		
RG10-		

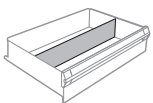

LEFT TO RIGHT PARTITIONS

	PRODUCT NO.	QUANTITY
RG0X-		
RG01-	42	

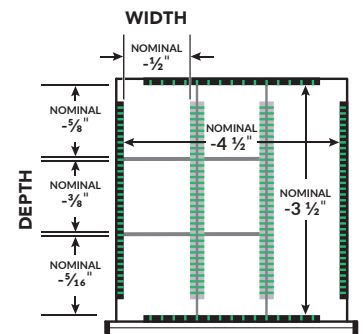
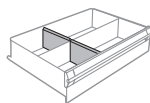

42"W DRAWERS

42" x 24"

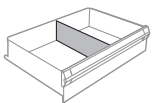
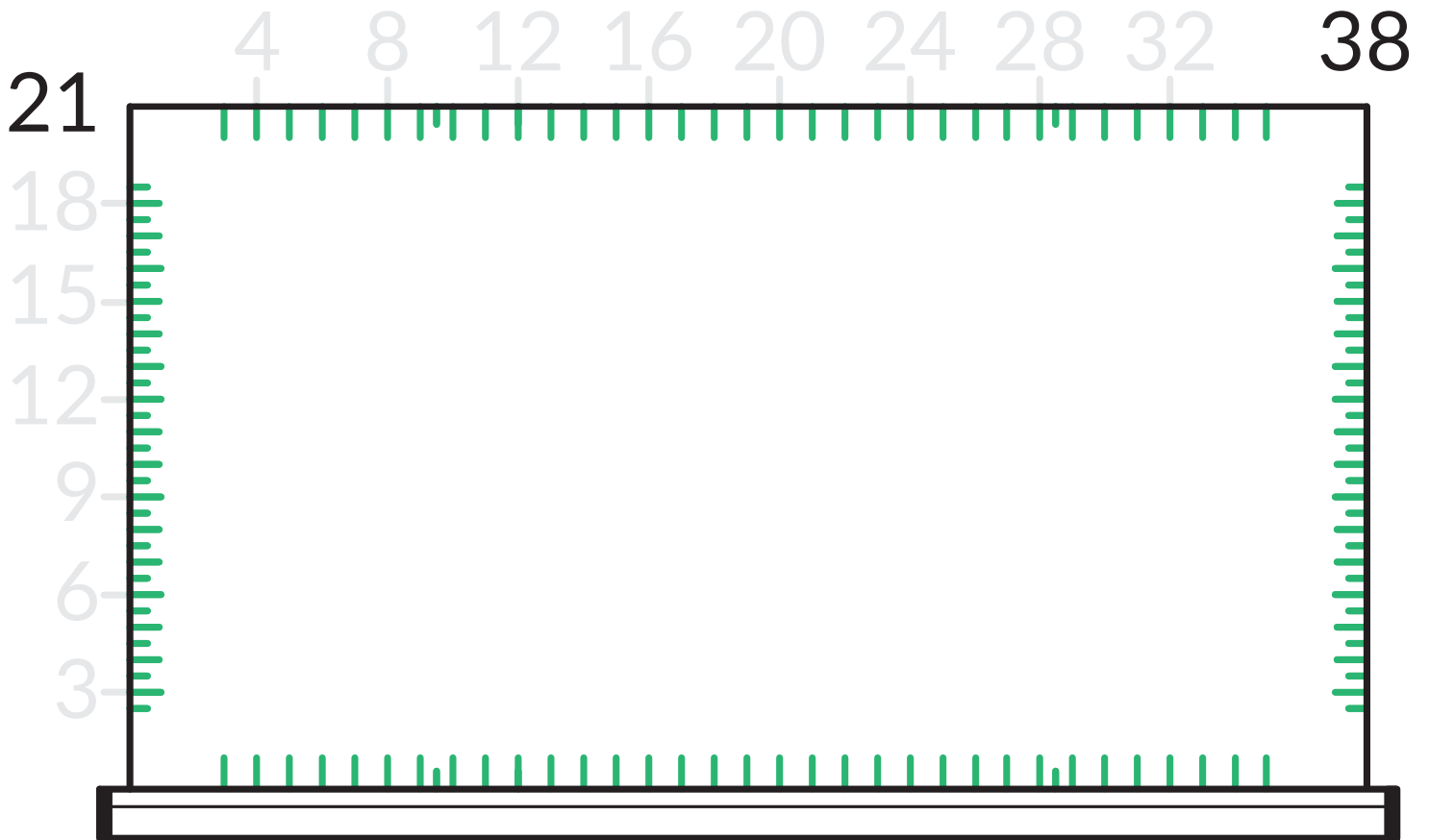

FRONT TO BACK PARTITIONS

	PRODUCT NO.	QUANTITY
	RG0X-	
	RG00-	24

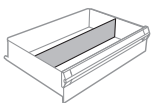
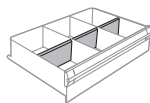

LEFT TO RIGHT PARTITIONS

	PRODUCT NO.	QUANTITY
	RG0X-	
	RG01-	42

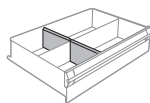

DIVIDERS

	PRODUCT NO.	QUANTITY
	RG10-	
	RG10-	
	RG10-	
	RG10-	
	RG10-	
	RG10-	

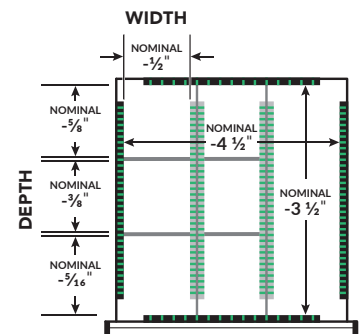

42"W DRAWERS



NON-STANDARD DIMENSIONS, CONTACT YOUR CUSTOMER SERVICE REPRESENTATIVE

42" x 27"

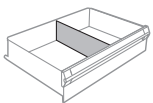
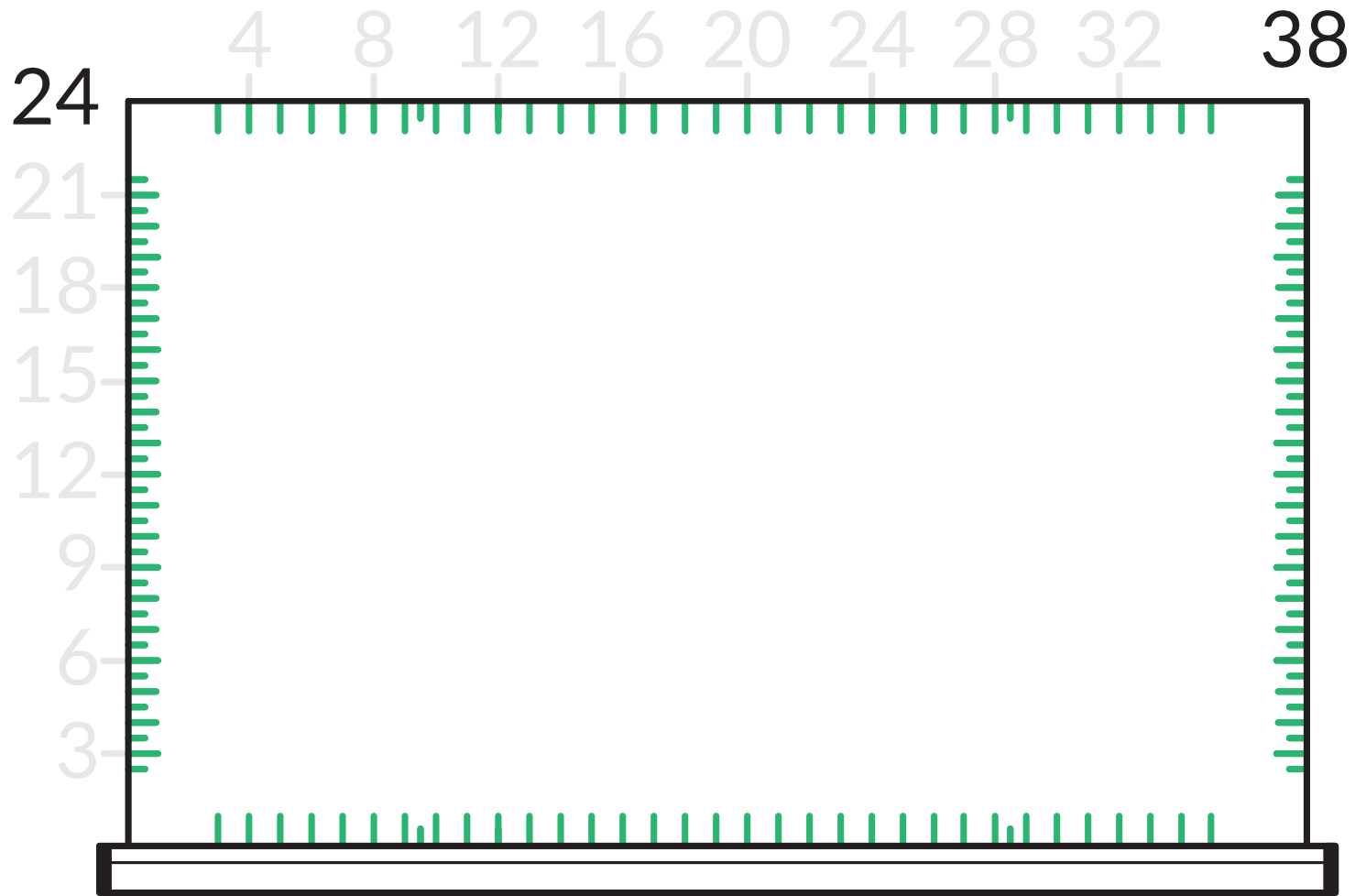

FRONT TO BACK PARTITIONS

	PRODUCT NO.	QUANTITY
RG0X-		
RG00-	27	

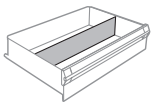
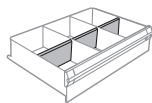

LEFT TO RIGHT PARTITIONS

	PRODUCT NO.	QUANTITY
RG0X-		
RG01-	42	

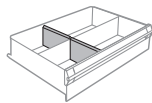

DIVIDERS

	PRODUCT NO.	QUANTITY
RG10-		
RG10-		
RG10-		
RG10-		
RG10-		
RG10-		

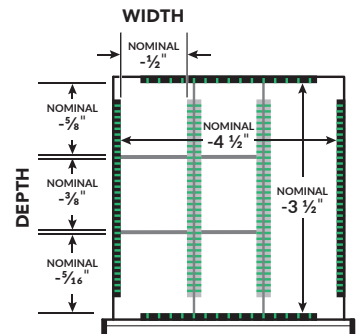

42" x 30"



NON-STANDARD DIMENSIONS, CONTACT YOUR CUSTOMER SERVICE REPRESENTATIVE

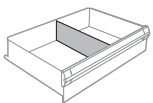
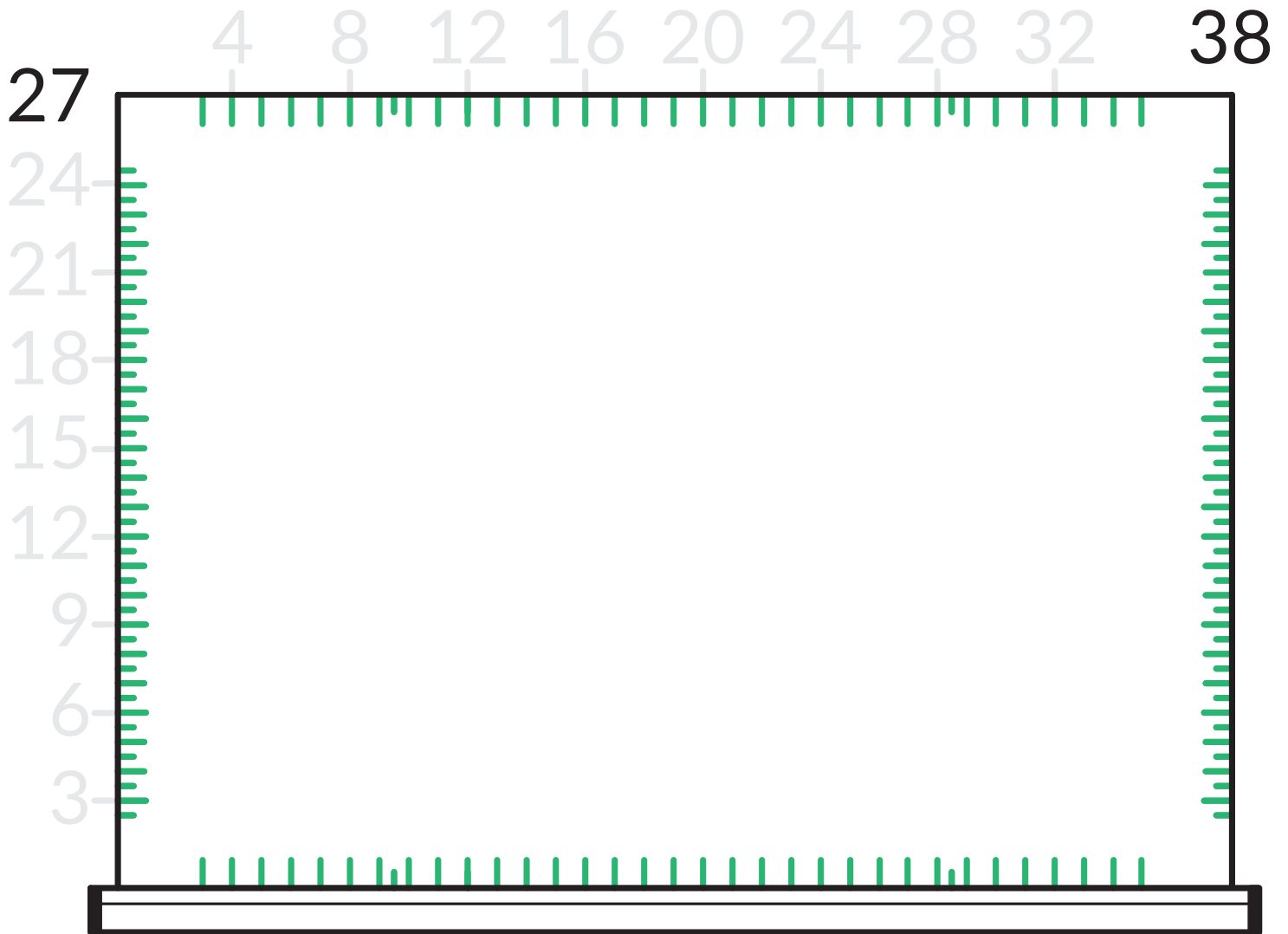

FRONT TO BACK PARTITIONS

	PRODUCT NO.	QUANTITY
RG0X-		
RG00-	30	

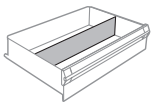
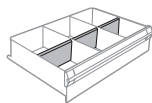

LEFT TO RIGHT PARTITIONS

	PRODUCT NO.	QUANTITY
RG0X-		
RG01-	42	

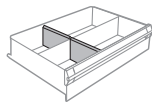

DIVIDERS

	PRODUCT NO.	QUANTITY
RG10-		
RG10-		
RG10-		
RG10-		
RG10-		
RG10-		

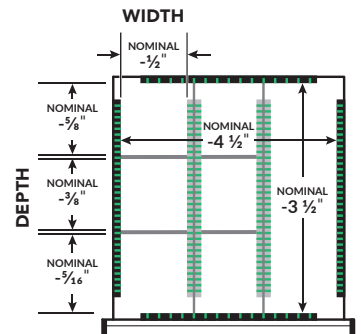

45"W DRAWER



NON-STANDARD DIMENSIONS, CONTACT YOUR CUSTOMER SERVICE REPRESENTATIVE

45" x 27"

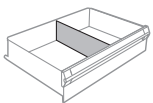
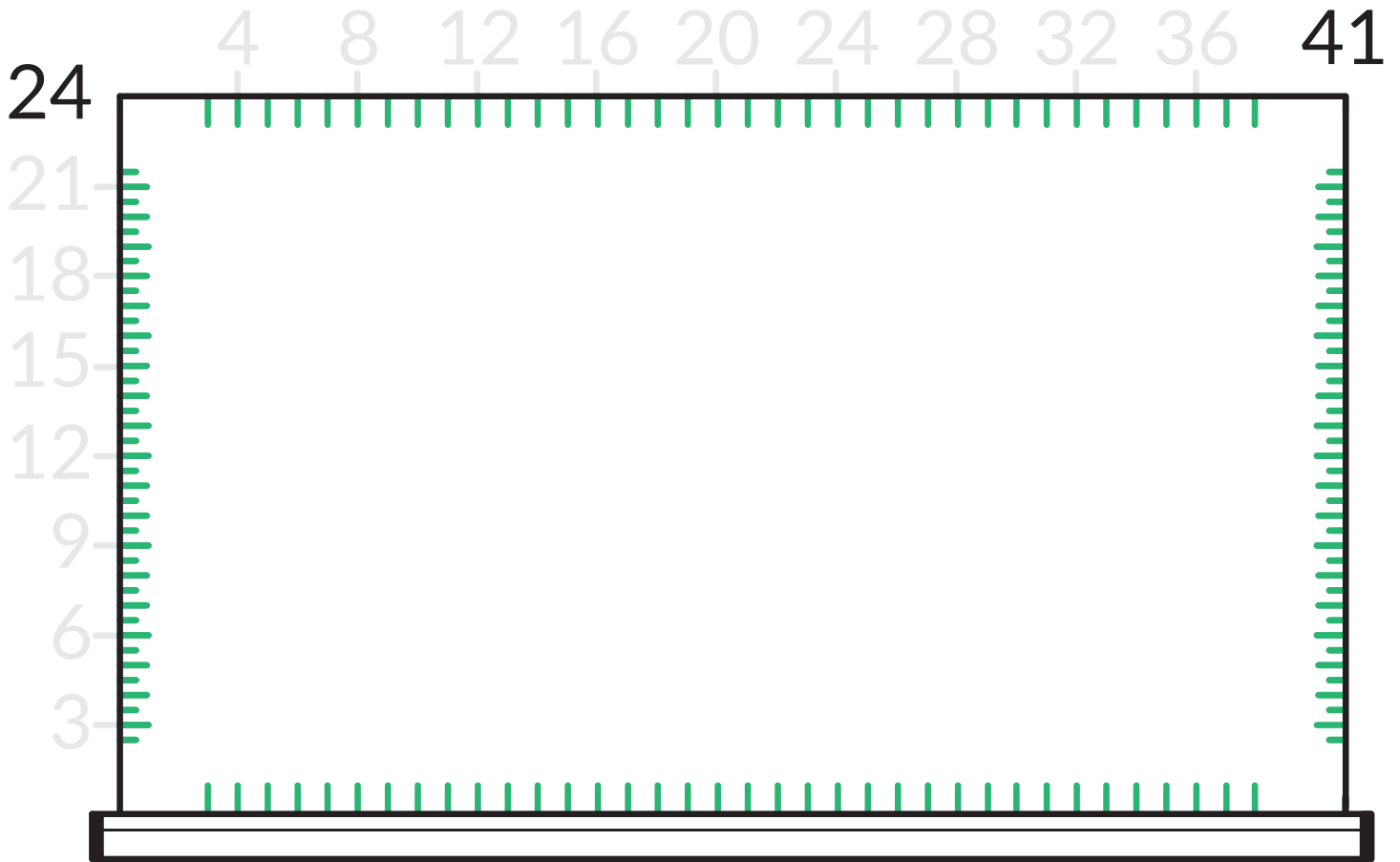

FRONT TO BACK PARTITIONS

	PRODUCT NO.	QUANTITY
RG0X-		
RG00-	27	

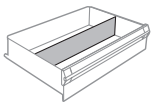
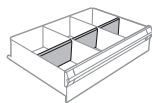

LEFT TO RIGHT PARTITIONS

	PRODUCT NO.	QUANTITY
RG0X-		
RG01-	45	

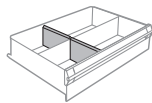

DIVIDERS

	PRODUCT NO.	QUANTITY
RG10-		
RG10-		
RG10-		
RG10-		
RG10-		
RG10-		

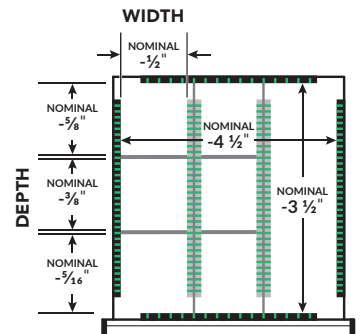

48"W DRAWERS

48" x 18"

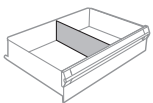
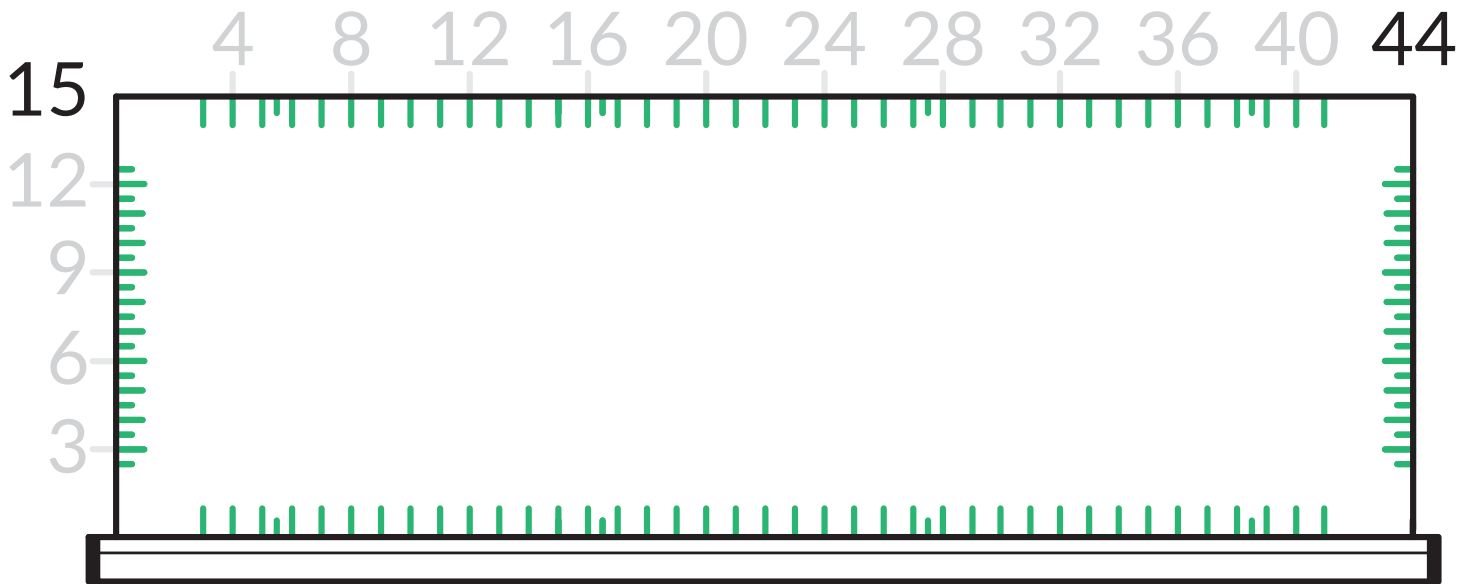

FRONT TO BACK PARTITIONS

	PRODUCT NO.	QUANTITY
RG0X-		
RG00-	18	

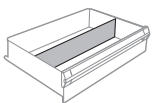
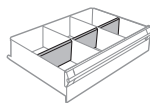

LEFT TO RIGHT PARTITIONS

	PRODUCT NO.	QUANTITY
RG0X-		
RG01-	48	

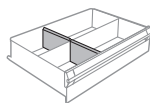

DIVIDERS

	PRODUCT NO.	QUANTITY
RG10-		
RG10-		
RG10-		
RG10-		
RG10-		
RG10-		

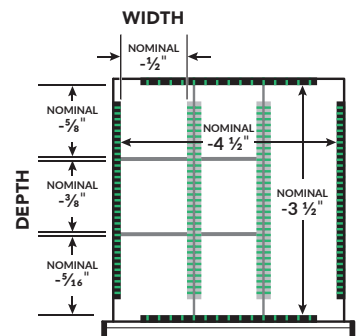

48"W DRAWERS



NON-STANDARD DIMENSIONS, CONTACT YOUR CUSTOMER SERVICE REPRESENTATIVE

48" x 21"

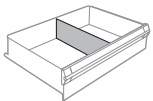
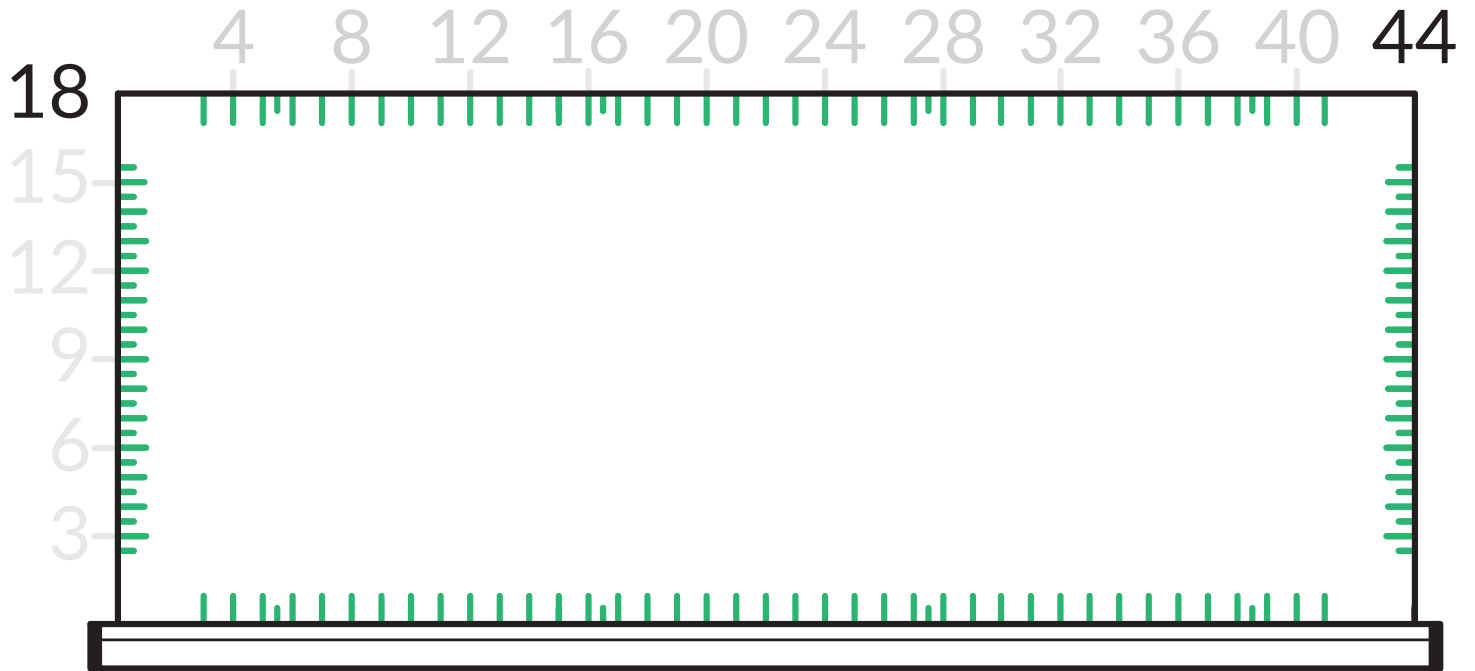

FRONT TO BACK PARTITIONS

	PRODUCT NO.	QUANTITY
RG0X-		
RG00-	21	

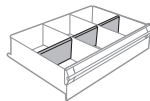

DIVIDERS

	PRODUCT NO.	QUANTITY
RG10-		
RG10-		
RG10-		
RG10-		
RG10-		
RG10-		

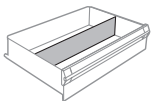

LEFT TO RIGHT PARTITIONS

	PRODUCT NO.	QUANTITY
RG0X-		
RG01-	48	

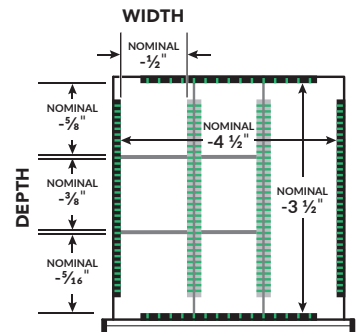
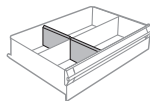

48"W DRAWERS

48" x 24"

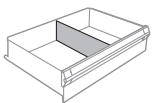
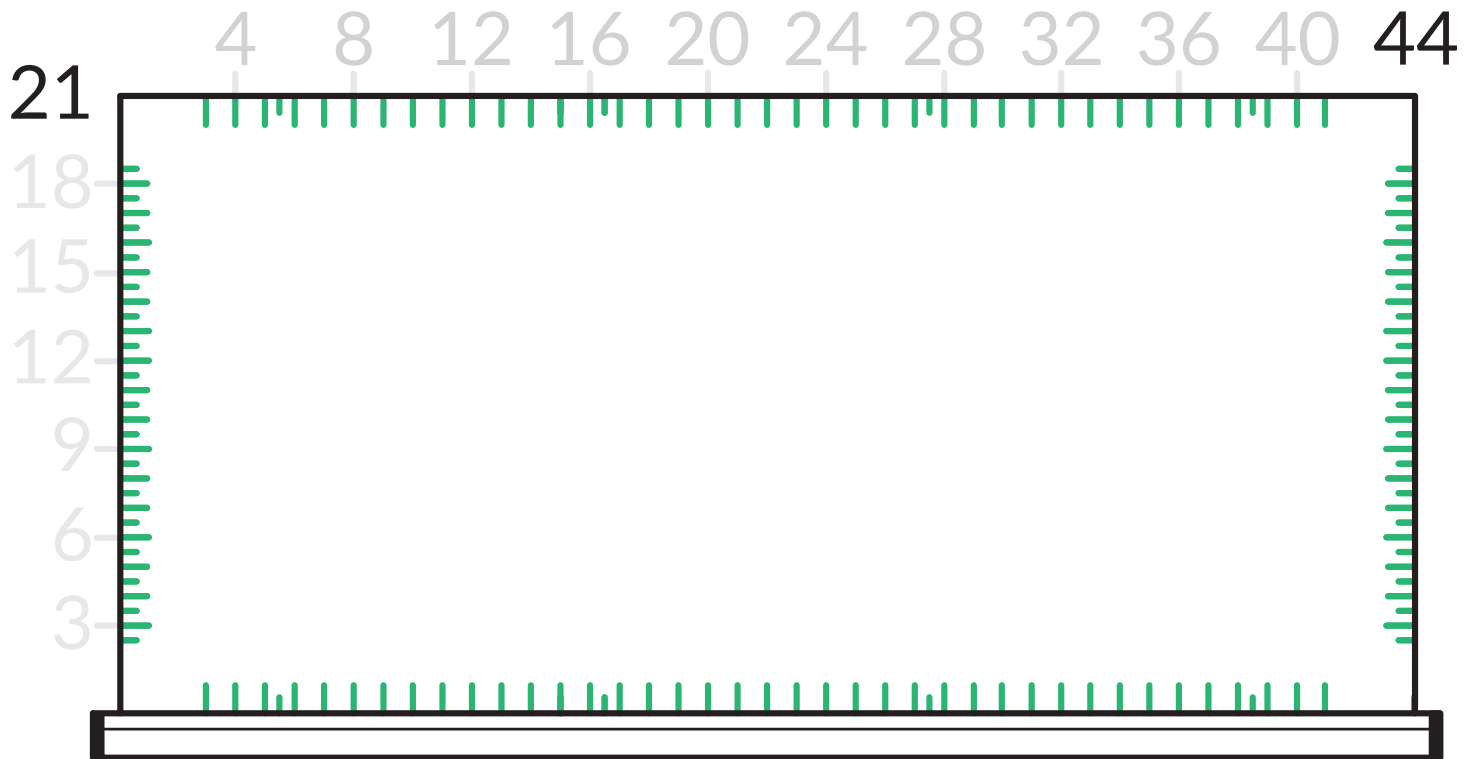

FRONT TO BACK PARTITIONS

	PRODUCT NO.	QUANTITY
RG0X-		
RG00-	24	

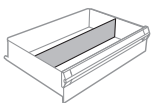
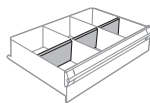

LEFT TO RIGHT PARTITIONS

	PRODUCT NO.	QUANTITY
RG0X-		
RG01-	48	

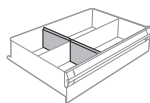

DIVIDERS

	PRODUCT NO.	QUANTITY
RG10-		
RG10-		
RG10-		
RG10-		
RG10-		
RG10-		

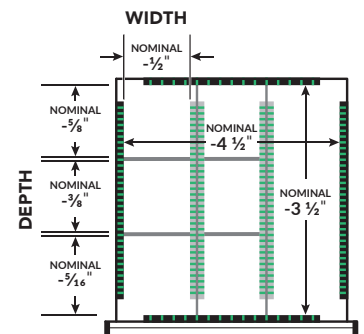

48"W DRAWERS

48" x 27"

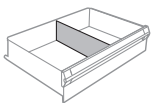

FRONT TO BACK PARTITIONS

	PRODUCT NO.	QUANTITY
RG0X-		
RG00-	27	

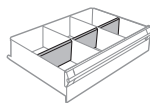

DIVIDERS

	PRODUCT NO.	QUANTITY
RG10-		
RG10-		
RG10-		
RG10-		
RG10-		
RG10-		
RG10-		

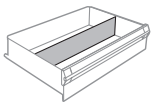

LEFT TO RIGHT PARTITIONS

	PRODUCT NO.	QUANTITY
RG0X-		
RG01-	48	

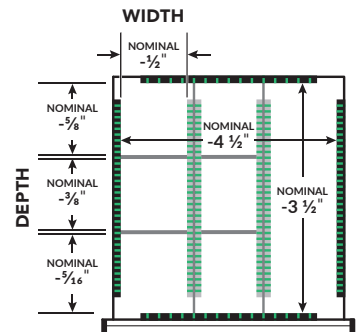
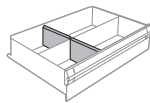

48" x 30"



NON-STANDARD DIMENSIONS, CONTACT YOUR CUSTOMER SERVICE REPRESENTATIVE

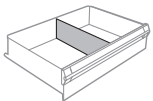
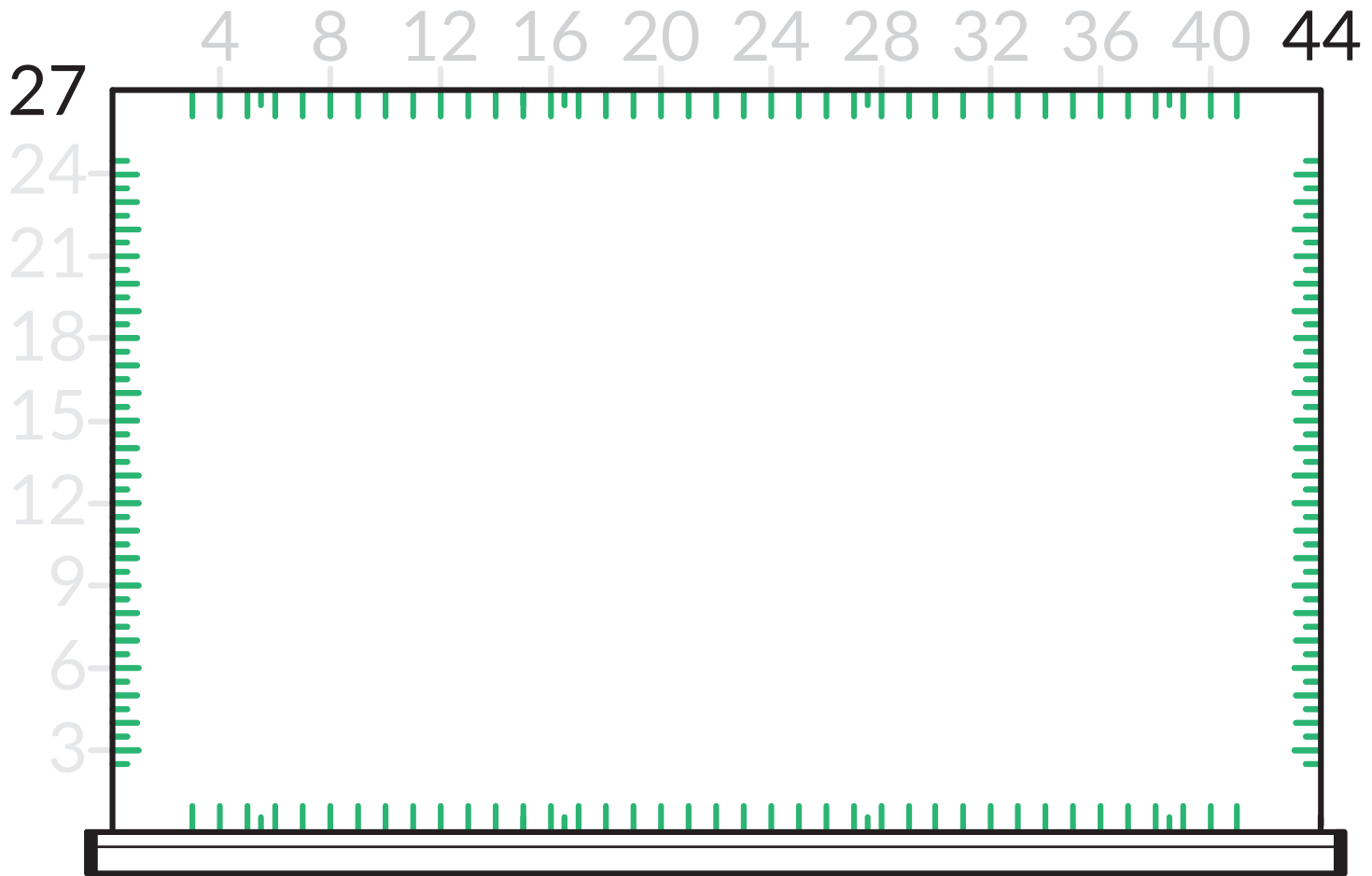

FRONT TO BACK PARTITIONS

	PRODUCT NO.	QUANTITY
RG0X-		
RG00-	30	

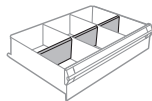

DIVIDERS

	PRODUCT NO.	QUANTITY
RG10-		
RG10-		
RG10-		
RG10-		
RG10-		
RG10-		

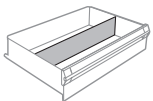

LEFT TO RIGHT PARTITIONS

	PRODUCT NO.	QUANTITY
RG0X-		
RG01-	48	

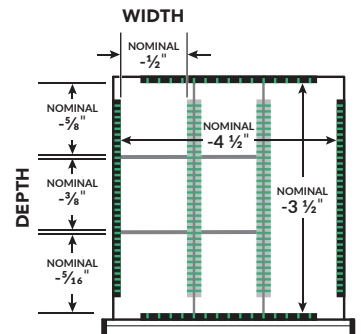
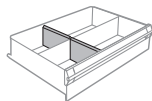

54"W DRAWERS

54" x 24"

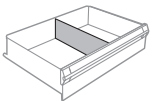
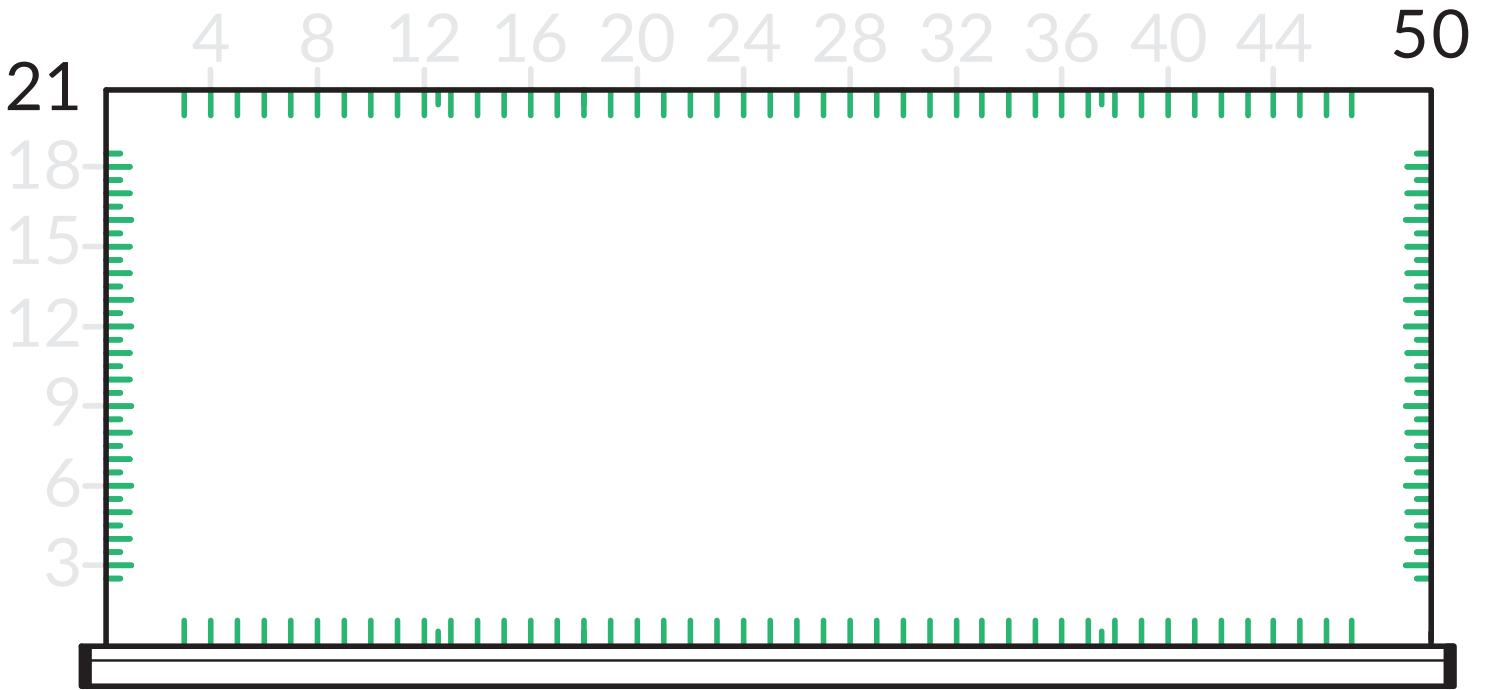

FRONT TO BACK PARTITIONS

	PRODUCT NO.	QUANTITY
RG0X-		<input type="text"/>
RG00-	24	<input type="text"/>

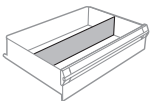
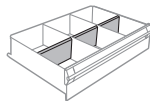

LEFT TO RIGHT PARTITIONS

	PRODUCT NO.	QUANTITY
RG0X-		<input type="text"/>
RG01-	54	<input type="text"/>

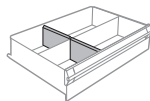

DIVIDERS

	PRODUCT NO.	QUANTITY
RG10-		<input type="text"/>
RG10-		<input type="text"/>
RG10-		<input type="text"/>
RG10-		<input type="text"/>
RG10-		<input type="text"/>
RG10-		<input type="text"/>

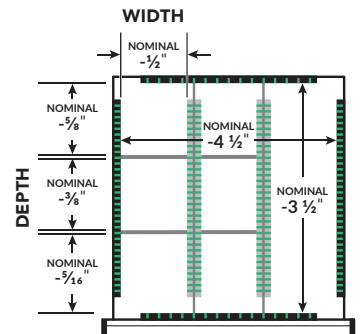

54"W DRAWERS

54" x 27"

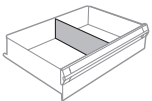
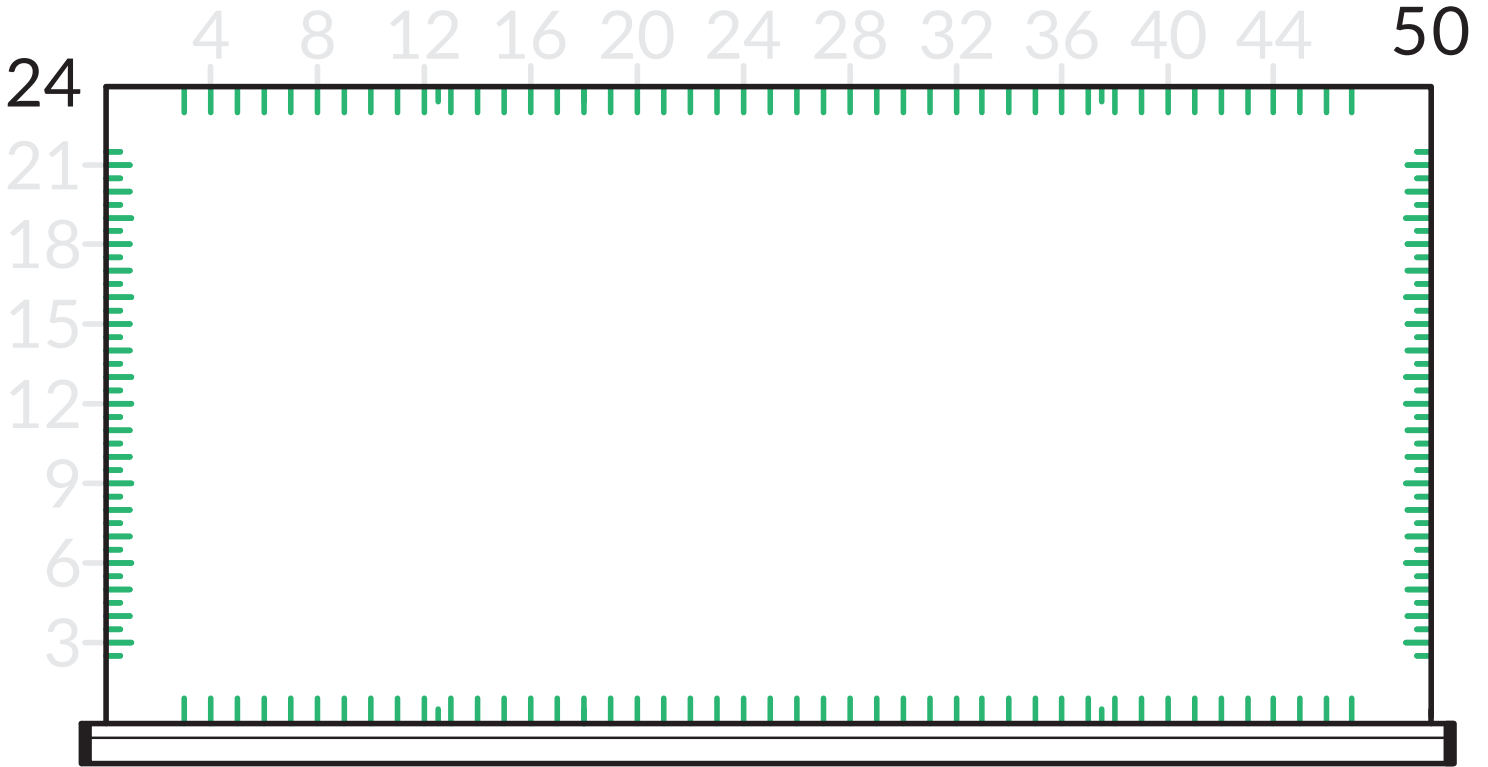

FRONT TO BACK PARTITIONS

	PRODUCT NO.	QUANTITY
RG0X-		
RG00-	27	

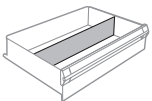
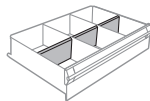

LEFT TO RIGHT PARTITIONS

	PRODUCT NO.	QUANTITY
RG0X-		
RG01-	54	

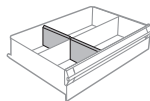

DIVIDERS

	PRODUCT NO.	QUANTITY
RG10-		
RG10-		
RG10-		
RG10-		
RG10-		
RG10-		

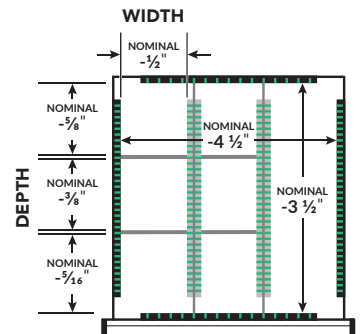

54"W DRAWERS



NON-STANDARD DIMENSIONS, CONTACT YOUR CUSTOMER SERVICE REPRESENTATIVE

54" x 30"

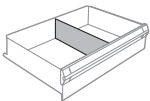
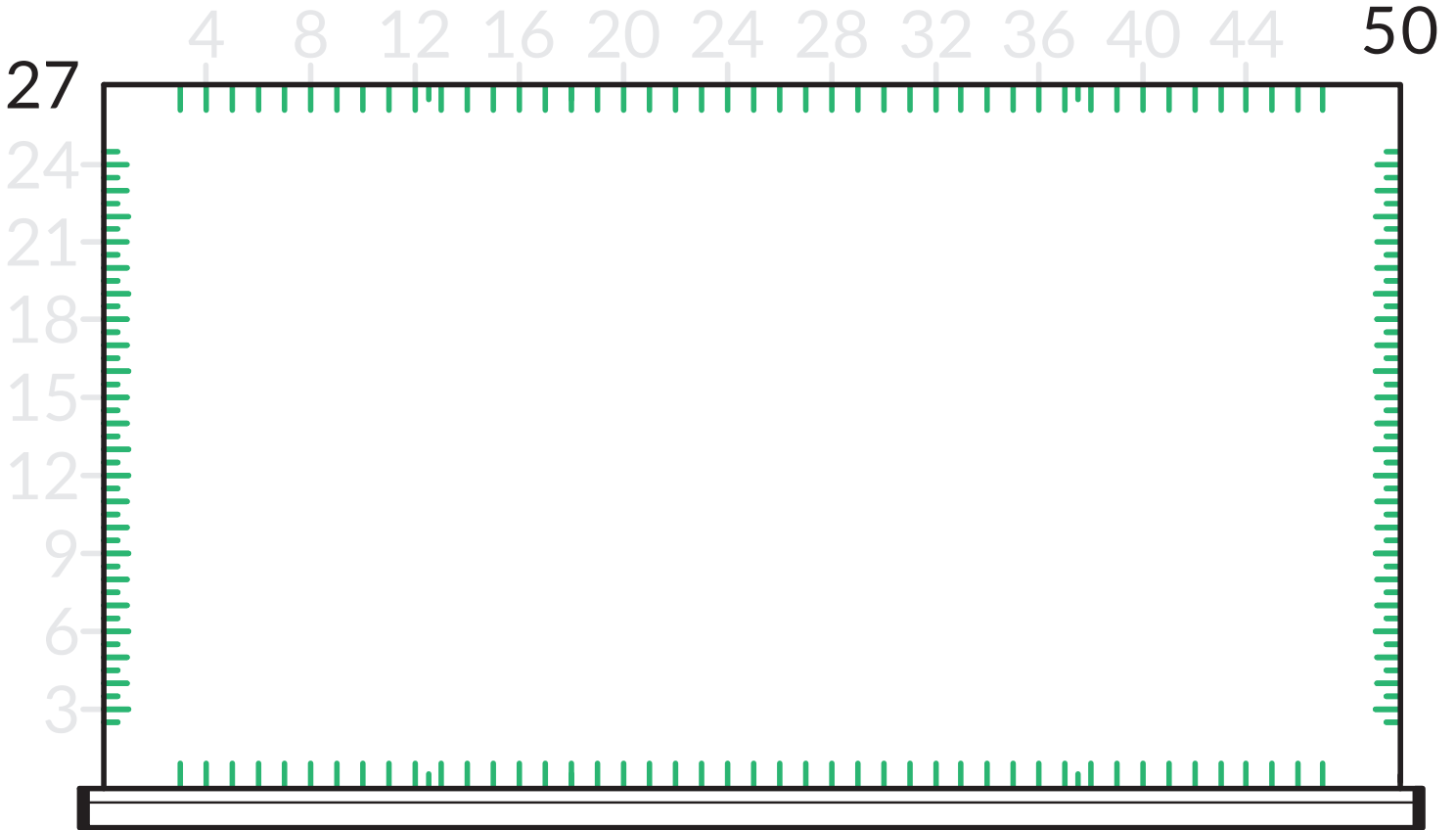

FRONT TO BACK PARTITIONS

	PRODUCT NO.	QUANTITY
RG0X-		
RG00-	30	

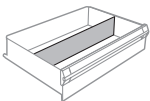
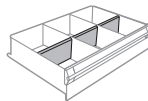

LEFT TO RIGHT PARTITIONS

	PRODUCT NO.	QUANTITY
RG0X-		
RG01-	54	

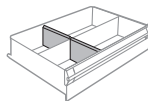

DIVIDERS

	PRODUCT NO.	QUANTITY
RG10-		
RG10-		
RG10-		
RG10-		
RG10-		
RG10-		

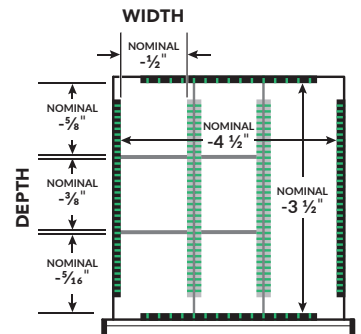

60"W DRAWERS

60" x 24"

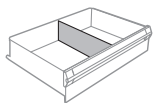
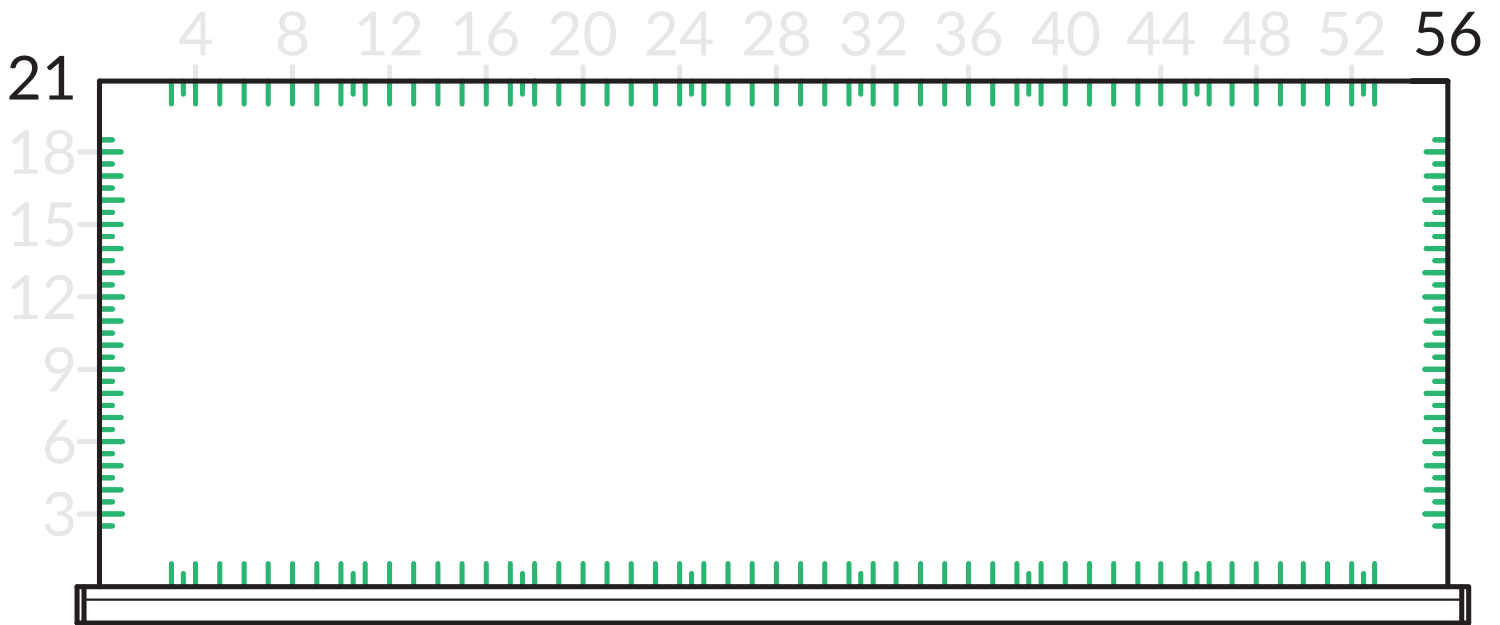

FRONT TO BACK PARTITIONS

	PRODUCT NO.	QUANTITY
RG0X-		
RG00-	24	

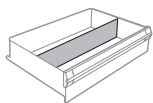
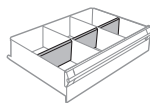

LEFT TO RIGHT PARTITIONS

	PRODUCT NO.	QUANTITY
RG0X-		
RG01-	60	

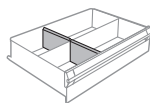

DIVIDERS

	PRODUCT NO.	QUANTITY
RG10-		
RG10-		
RG10-		
RG10-		
RG10-		
RG10-		

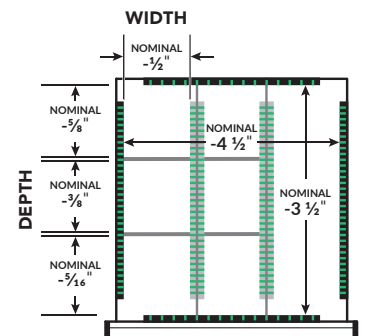

60"W DRAWERS

60" x 27"

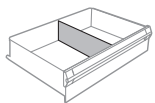
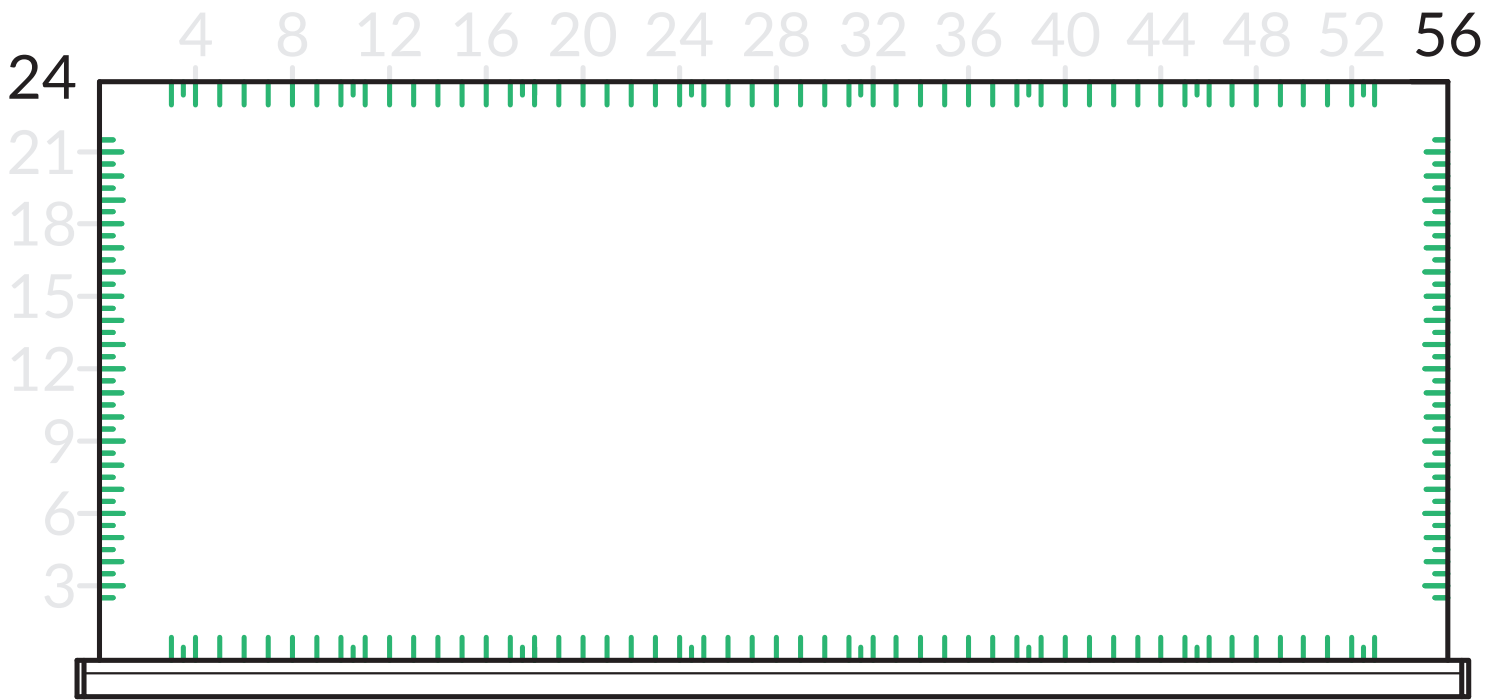

FRONT TO BACK PARTITIONS

	PRODUCT NO.	QUANTITY
RG0X-		
RG00-	27	

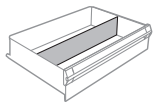
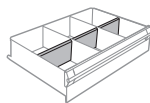

LEFT TO RIGHT PARTITIONS

	PRODUCT NO.	QUANTITY
RG0X-		
RG01-	60	

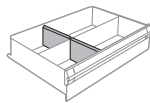

DIVIDERS

	PRODUCT NO.	QUANTITY
RG10-		
RG10-		
RG10-		
RG10-		
RG10-		
RG10-		

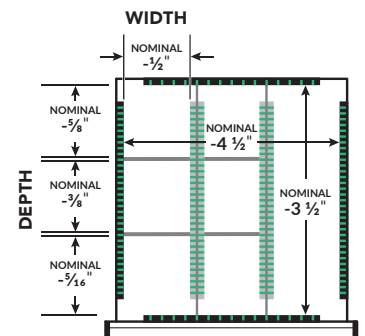

60"W DRAWERS



NON-STANDARD DIMENSIONS, CONTACT YOUR CUSTOMER SERVICE REPRESENTATIVE

60" x 30"

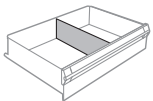
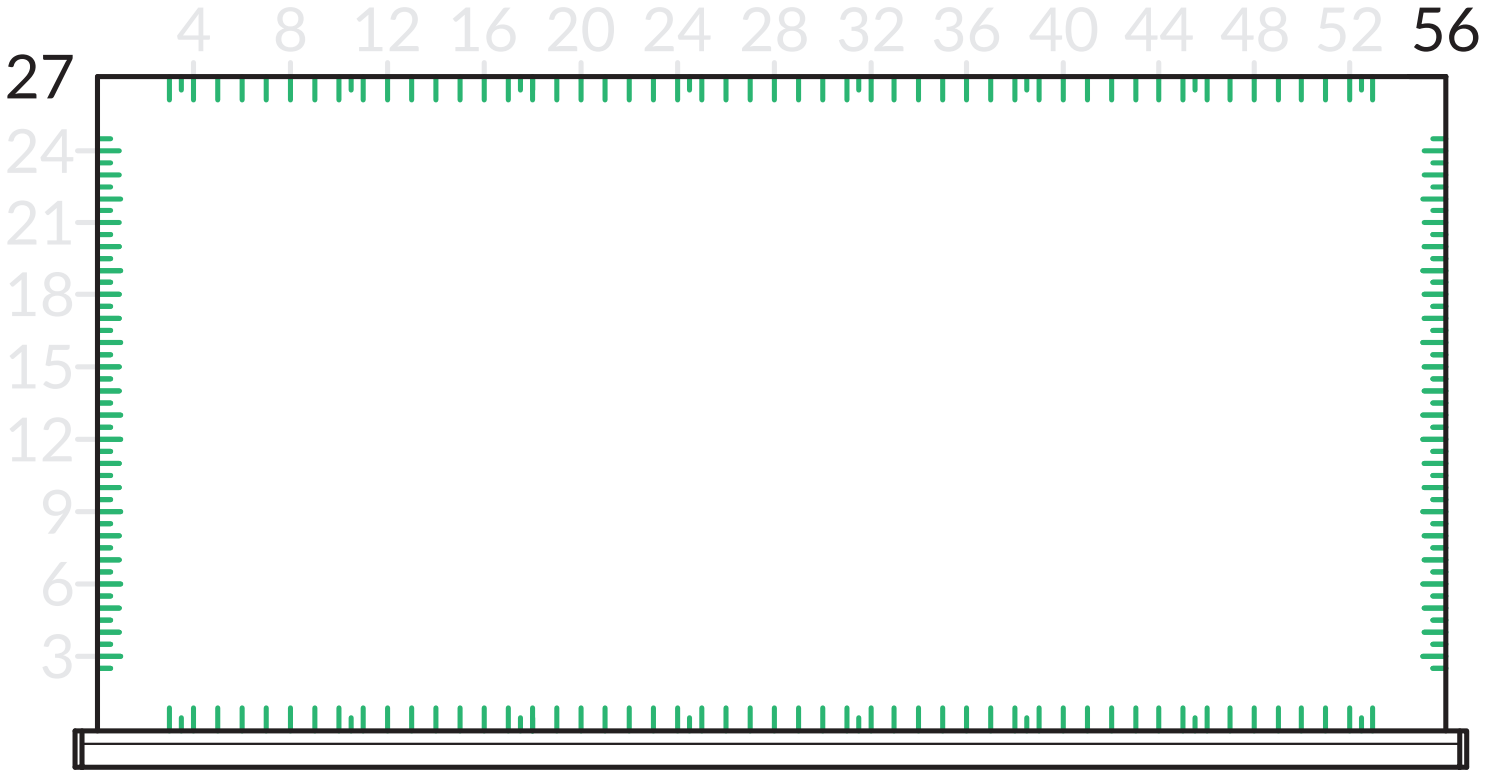

FRONT TO BACK PARTITIONS

	PRODUCT NO.	QUANTITY
RG0X-		
RG00-	30	

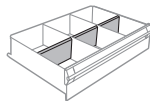

LEFT TO RIGHT PARTITIONS

	PRODUCT NO.	QUANTITY
RG0X-		
RG01-	60	

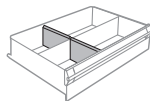

DIVIDERS

	PRODUCT NO.	QUANTITY
RG10-		
RG10-		
RG10-		
RG10-		
RG10-		
RG10-		

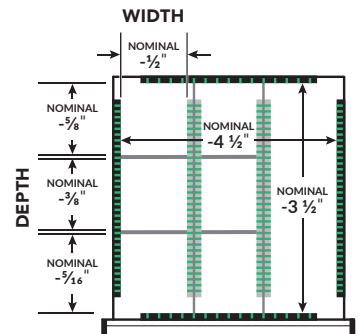

ACCESSORIES

SUBDIVIDING ACCESSORIES

Our tool-free "clip-in" subdividing system keeps the dividers firmly in place and reduces noise caused by vibrations.

FRONT TO BACK PARTITION

RG00

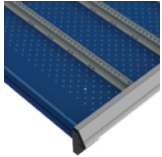

- Divides the drawer along its depth
- Clip-in system locks dividers in place
- Adjustable in 1" increments (c/c)
- Color: Light Gray (#071)
- Compatible with the following accessories: plastic bins (RG20/RG21), groove trays (RG35), hanging file bars (RG30/RG31) and PVC drawer liners (RG40)

NOMINAL DRAWER HEIGHT (ACTUAL)

NOMINAL DRAWER DEPTH (ACTUAL)	3" (1½"H)	4" (2¾"H)	5" (3¾"H)	6" AND 7" (4¾"H)	8" AND 9" (6¾"H)	10" (8¾"H)	12" AND 14" (10¾"H)
18" (15")	RG00-1803	RG00-1804	RG00-1805	RG00-1806	RG00-1808	RG00-1810	RG00-1812
21" (18")	RG00-2103	RG00-2104	RG00-2105	RG00-2106	RG00-2108	RG00-2110	RG00-2112
24" (21")	RG00-2403	RG00-2404	RG00-2405	RG00-2406	RG00-2408	RG00-2410	RG00-2412
27" (24")	RG00-2703	RG00-2704	RG00-2705	RG00-2706	RG00-2708	RG00-2710	RG00-2712
30" (27")*	RG00-3003	RG00-3004	RG00-3005	RG00-3006	RG00-3008	RG00-3010	RG00-3012

NOTE: * The 30"D dimension is not a standard size. Contact your customer service representative for more information.

LEFT TO RIGHT PARTITION

RG01

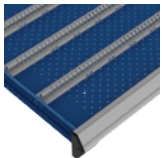

- Divides the drawer across its width
- Clip-in system locks dividers in place
- Adjustable in ½" increments (c/c)
- Color: Light Gray (#071)
- Compatible with the following accessories: plastic bins (RG20/RG21), groove trays (RG35), hanging file bars (RG30/RG31) and PVC drawer liners (RG40)

NOMINAL DRAWER HEIGHT (ACTUAL)

NOMINAL DRAWER WIDTH (ACTUAL)	3" (1½"H)	4" (2¾"H)	5" (3¾"H)	6" AND 7" (4¾"H)	8" AND 9" (6¾"H)	10" (8¾"H)	12" AND 14" (10¾"H)
18" (14")	RG01-1803	RG01-1804	RG01-1805	RG01-1806	RG01-1808	RG01-1810	RG01-1812
24" (20")	RG01-2403	RG01-2404	RG01-2405	RG01-2406	RG01-2408	RG01-2410	RG01-2412
30" (26")	RG01-3003	RG01-3004	RG01-3005	RG01-3006	RG01-3008	RG01-3010	RG01-3012
36" (32")	RG01-3603	RG01-3604	RG01-3605	RG01-3606	RG01-3608	RG01-3610	RG01-3612
42" (38")	RG01-4203	RG01-4204	RG01-4205	RG01-4206	RG01-4208	RG01-4210	RG01-4212
48" (44")	RG01-4803	RG01-4804	RG01-4805	RG01-4806	RG01-4808	RG01-4810	RG01-4812
54" (50")	RG01-5403	RG01-5404	RG01-5405	RG01-5406	RG01-5408	RG01-5410	RG01-5412
60" (56")	RG01-6003	RG01-6004	RG01-6005	RG01-6006	RG01-6008	RG01-6010	RG01-6012

DRAWER DIVIDER

RG10

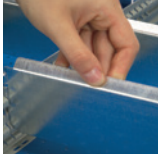

- Dividers clip in place
- 45° angled edge for easy identification of compartment contents
- Galvanized steel
- Adjustable in ½" increments (c/c)

NOMINAL DRAWER HEIGHT (ACTUAL)

NOMINAL DIVIDER WIDTH	3" (1½"H)	4" (2½"H)	5" (3½"H)	6" AND 7" (4¾"H)	8" AND 9" (6¾"H)	10" (8¾"H)	12" AND 14" (10¾"H)
3"	RG10-03003	RG10-03004	RG10-03005	RG10-03006	-	-	-
*3.5"	RG10-03503	RG10-03504	RG10-03505	RG10-03506	-	-	-
4"	RG10-04003	RG10-04004	RG10-04005	RG10-04006	-	-	-
5"	RG10-05003	RG10-05004	RG10-05005	RG10-05006	RG10-05008	RG10-05010	-
*5.5"	RG10-05503	RG10-05504	RG10-05505	RG10-05506	RG10-05508	RG10-05510	-
6"	RG10-06003	RG10-06004	RG10-06005	RG10-06006	RG10-06008	RG10-06010	RG10-06012
*6.5"	RG10-06503	RG10-06504	RG10-06505	RG10-06506	RG10-06508	RG10-06510	RG10-06512
7"	RG10-07003	RG10-07004	RG10-07005	RG10-07006	RG10-07008	RG10-07010	RG10-07012
8"	RG10-08003	RG10-08004	RG10-08005	RG10-08006	RG10-08008	RG10-08010	RG10-08012
9"	RG10-09003	RG10-09004	RG10-09005	RG10-09006	RG10-09008	RG10-09010	RG10-09012
*9.5"	RG10-09503	RG10-09504	RG10-09505	RG10-09506	RG10-09508	RG10-09510	RG10-09512
10"	RG10-10003	RG10-10004	RG10-10005	RG10-10006	RG10-10008	RG10-10010	RG10-10012
11"	RG10-11003	RG10-11004	RG10-11005	RG10-11006	RG10-11008	RG10-11010	RG10-11012
12"	RG10-12003	RG10-12004	RG10-12005	RG10-12006	RG10-12008	RG10-12010	RG10-12012
13"	RG10-13003	RG10-13004	RG10-13005	RG10-13006	RG10-13008	RG10-13010	RG10-13012
14"	RG10-14003	RG10-14004	RG10-14005	RG10-14006	RG10-14008	RG10-14010	RG10-14012
16"	RG10-16003	RG10-16004	RG10-16005	RG10-16006	RG10-16008	RG10-16010	RG10-16012

NOTE: * These dimensions are not compatible with all drawer widths.

w.w.Cannon, Inc.
Design. Layout. Build. Install.
 1-800-442-3061
 www.wwcannon.com

For more information, contact our representative:



ROUSSEAU METAL INC.

105, avenue de Gaspé Ouest
 Saint-Jean-Port-Joli (Québec)
 G0R 3G0 CANADA

DISTRIBUTORS
 1.800.463.4271

END USERS
 1.866.463.4270

EMAIL
 info@rousseau.com

WEBSITE
 rousseau.com

DISTRIBUTORS ACCESS
 e-rousseau.com

CONFIGURATOR
 MyModel-r.com

