



*"Bringing Order To Chaos"*  
**www.Cannon,Inc.**  
Design. Layout. Build. Install.  
1-800-442-3061  
www.wvcannon.com  
*"Bringing Order To Chaos"*



# Pallet Rack Storage Systems



# RIDG-U-RAK®

# Your Single Source for Quality Pallet Rack Storage Systems

Ridg-U-Rak is a world-class manufacturer of quality pallet rack storage systems as well as a wide variety of other systems. Since 1942, Ridg-U-Rak has been a pioneer in the development of innovative pallet rack storage with more than 400,000 square feet of production and warehouse space. As such, we are able to effectively serve as your single source for all your pallet rack storage requirements. For information on how we can help in your pallet rack selection, please call... Toll Free 1-866-479-7225. We're ready when you are.

## Roll Formed Columns and Beams

At the heart of most Ridg-U-Rak structures is our famous roll-formed column design. Each upright is fully welded using heavy-duty bracing and base plates to ensure structural integrity and to eliminate installation delays and costs inherent in bolt-together uprights.

In addition to roll formed sections, we offer structural steel shapes in a virtually unlimited selection of sizes and capacities to meet your requirements.

Ridg-U-Rak offers a wide variety of column and beam profiles in various gages to provide our customers with the most efficient solutions possible. All uprights, beams and support components are engineered to maximum load capacities while minimizing weight to reduce cost.



*Original Slotted*

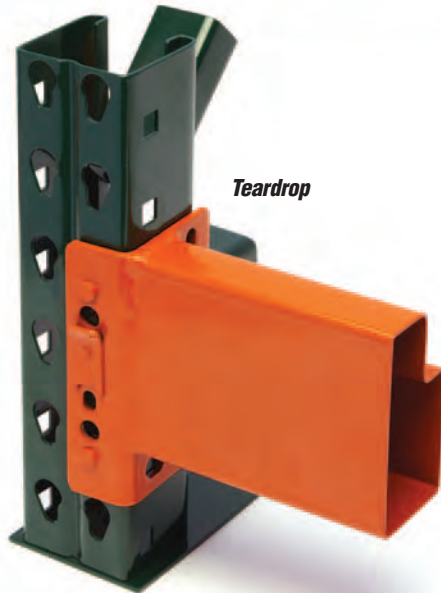

*Teardrop*



*Hybrid  
Structural Frame  
Roll-form Beam*

## Leading the Industry in Pallet Rack Storage Systems

Ridg-U-Rak is one of the largest pallet rack storage manufacturers in North America, producing more than 100 million pounds of pallet rack, high density storage rack and specialized rack systems annually. We offer engineering, design, project management and installation services that meet your pallet rack needs on time and on budget.

Our customers include distribution centers, manufacturing facilities, large scale retail and home improvement outlets, industrial warehouses and assembly operations. The Ridg-U-Rak team has the experience to handle projects ranging from small selective systems to large complex projects incorporating a variety of storage solutions. A national network of distributors provide knowledgeable service, and their stocking locations supply a "quick ship" option for standard products.

For over 75 years, Ridg-U-Rak has been a pioneer in developing and improving pallet rack safety, including Column Sentry reinforcements, slant back/offset uprights, beam-to-column locking mechanisms and Seismic Base Isolation technology.



## Where to find it...



### Slotted Rack

Frames & Beams.....4-5



### Teardrop Rack

Frames & Beams.....6-7



### Structural Steel Rack

Frames & Beams.....8-9

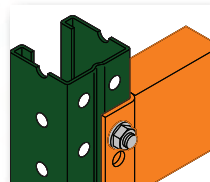

### Frame Options.....10

### Beam Options.....11



### Column Sentry

Reinforcing for  
Impact Protection.....12-13

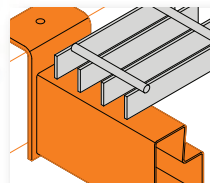

### Accessories

Slotted & Teardrop Beams.....14

Structural Steel Beams.....15



# Slotted Frames

Ridg-U-Rak original slotted pallet rack systems feature automatic lock beam-to-column connections and are available in a virtually unlimited selection of sizes and load capacities. Our six-bend, roll-formed columns with fully welded bracing set the standard for rigidity, strength and durability in pallet rack systems.

Slotted pallet rack is available in a vast array of sizes and load capacities and is extremely versatile. The slotted system features long-lasting powder coated finishes to ensure enduring performance.

## Features

- Roll-formed columns 180° return flanges
- 100% welded uprights
- Superior bracing design
- Offset anchor holes
- 4" vertical adjustability

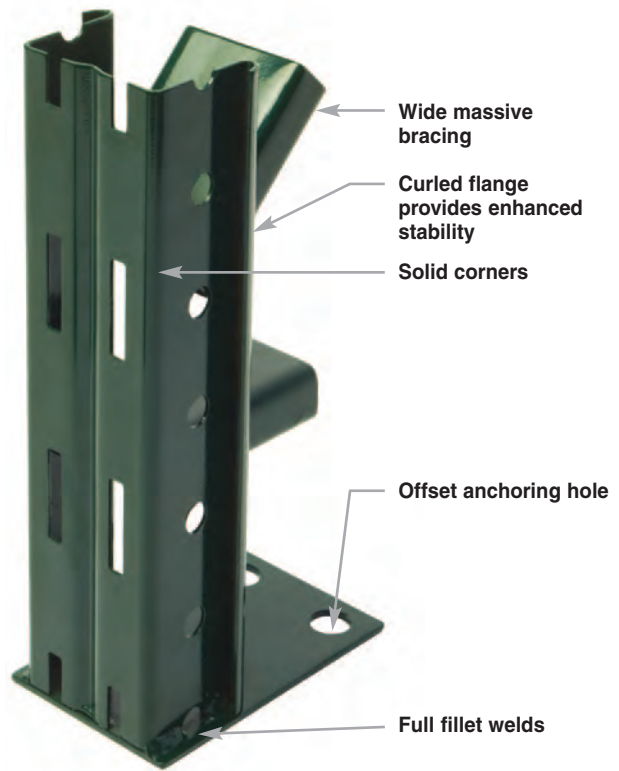

## Frame Capacities

Vertical Beam Spacing	32C (3X2-1/4)			33C (3X3)					43C (4X3)	
	UF-S32C	UF-M32C	UF-H32C	UF-S33C	UF-R33C	UF-M33C	UF-Y33C	UF-H33C	UF-M43C	UF-H43C
36"	24,700	29,800	36,400	29,800	35,500	40,500	44,000	49,100	51,700	63,200
42"	23,500	27,900	34,100	28,100	33,500	37,100	41,300	45,000	49,400	61,100
48"	22,100	26,900	32,800	26,200	31,100	35,300	38,300	42,700	48,000	58,700
54"	20,700	25,700	31,300	24,200	28,700	33,300	35,100	40,400	46,600	55,900
60"	19,000	23,200	28,200	22,000	26,000	29,300	31,800	35,400	43,400	53,000
72"	15,700	19,100	23,200	17,700	20,800	23,300	25,200	28,100	38,100	46,500
84"	12,400	15,200	18,500	13,800	16,100	17,900	19,400	21,600	32,600	39,700
96"	9,900	12,300	14,800	10,900	12,700	14,100	15,300	17,000	27,200	33,100
108"	8,000	10,000	12,100	8,900	10,300	11,400	12,300	13,700	22,200	26,900

Consult with factory for vertical beam-to-beam spacings greater than 108"

- The Frame Capacity Chart gives allowable loads based on the specified "Unsupported Length" of the columns.
- Values shown are in full compliance with the current RMI Specifications.
- The loads on upright frames accumulate from top to bottom, therefore, the unsupported length and the column load below each beam level should be checked to determine the worst-case scenario.
- The capacities shown in this table are for static load conditions only.
- For other special conditions such as seismic or wind loadings, consult with Ridg-U-Rak sales.

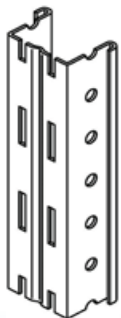

Style 32C



Style 33C



Style 43C



# Slotted Beams

Ridg-U-Rak offers many standard beam profiles in virtually any length with capacities to 22,500 lbs. per pair. Beams have a safety factor of 1.67 based on minimum yield of steel. All beam capacities are calculated based on the requirements of the current RMI specification.

All capacities are based on uniformly distributed loads on a pair of beams. Other loading conditions can greatly reduce the carrying capacity of a beam. For unusual loading requirements, call your local Ridg-U-Rak distributor.

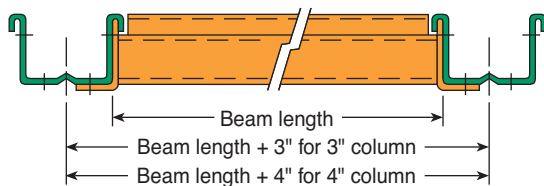

## Beam Capacities

Beam Profile	Beam Lengths										
	48"	60"	72"	84"	92"	96"	102"	108"	120"	144"	156"
250 S	5,700	4,530	3,130	2,300	1,910	1,750	1,550	1,380	1,120	770	660
300 S	7,500	5,980	4,820	3,530	2,940	2,690	2,380	2,120	1,720	1,190	1,010
355 S	9,760*	7,770	6,460	5,330	4,440	4,070	3,600	3,210	2,590	1,790	1,520
410 L	10,810*	8,620	7,150	6,110	5,570	5,200	4,600	4,100	3,310	2,290	1,940
410 S	12,270*	9,780*	8,120	6,930	6,320	5,830	5,160	4,600	3,710	2,570	2,180
465 S	15,020*	11,970*	9,940*	8,490	7,740	7,410	6,960	6,320	5,110	3,530	3,000
500 S	16,890*	13,460*	11,170*	9,540*	8,700	8,330	7,830	7,380	6,140	4,250	3,610
550 S	19,720*	15,710*	13,050*	11,150*	10,160*	9,720*	9,140*	8,620	7,740	5,420	4,610
600 S	22,500*	18,120*	15,050*	12,850*	11,710*	11,210*	10,540*	9,940*	8,920	6,790	5,770
650 S	22,500*	20,670*	17,160*	14,660*	13,360*	12,790*	12,020*	11,340*	10,180*	8,360	7,110
650 R	22,500*	22,500*	19,480*	16,640*	15,160*	14,520*	13,640*	12,870*	11,550*	9,370*	7,970

- Capacities marked with \* indicate that the column connection capacity may be limited based on the hook option and/or frame model (see table below).
- Capacities listed are for non-seismic conditions. For seismic conditions consult with Ridg-U-Rak sales or engineering.
- Capacities are based on uniformly distributed loads per pair of beams.
- Capacities listed are for a 2-pallet wide condition.
- All beams over 114" in length should utilize at least one flanged, tek-screwed or lock-in cross bar located at mid length.

### Beam Profile Dimensions

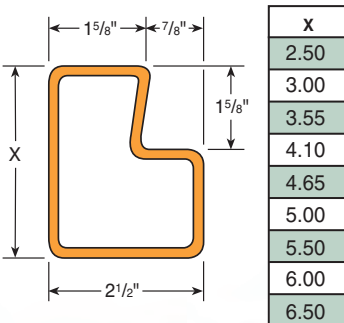

Upright Frame Model	Maximum Beam Capacities (per pair)	
	2-Lug Hook #02	3-Lug Hook #03
UF-S	9,000 lbs	13,000 lbs
UF-R	13,500 lbs	16,000 lbs
UF-M	12,000 lbs	18,000 lbs
UF-Y	13,000 lbs	19,500 lbs
UF-H	15,000 lbs	22,500 lbs

Hook # 02 is standard for beams 2.50", 3.00", 3.55", 4.10", 5.00", 5.50", 6.00" tall

Hook # 03 is standard for beams 6.50" tall

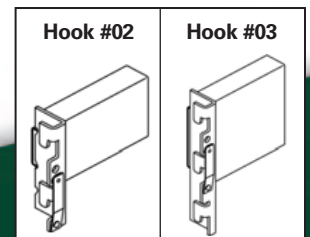

# Teardrop Frames

Teardrop systems offer easy assembly with 2" vertical beam adjustments. No tools are required. The teardrop beam-to-column connection is designed to be compatible with other widely available teardrop systems.

## Features

- Offset anchor holes
- Full array of profiles to optimize the solution
- 2" vertical adjustability
- 6 bend column
- 100% welded uprights

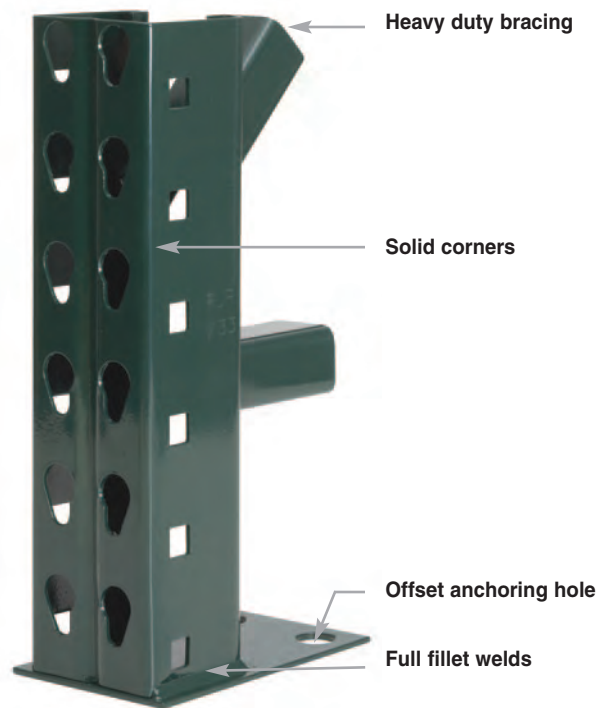

## Frame Capacities

Vertical Beam Spacing	31I 3 x 1-5/8		32I 3 x 2-1/4		33I 3 X 3			43I 4 x 3	
	UF-S31I	UF-S32I	UF-S33I	UF-R33I	UF-M33I	UF-Y33I	UF-H33I	UF-M43I	UF-H43I
36"	19,100	23,500	28,600	34,100	38,800	42,100	47,000	47,900	62,600
42"	17,900	22,100	26,900	33,100	35,600	39,500	43,000	45,700	60,500
48"	16,700	20,600	25,100	29,800	33,800	36,600	40,900	44,500	58,100
54"	15,200	18,900	23,100	27,500	31,900	33,600	38,600	43,100	55,300
60"	13,800	17,200	21,100	25,000	28,100	30,400	33,900	40,200	52,400
72"	10,800	13,700	17,000	20,000	22,300	24,100	26,800	35,300	46,000
84"	8,200	10,600	13,200	15,400	17,200	18,600	20,700	30,200	39,300
96"	6,500	8,400	10,500	12,200	13,500	14,700	16,300	25,200	32,800
108"	5,200	6,800	8,500	9,900	10,900	11,800	13,100	20,500	26,600

Consult with factory for vertical beam-to-beam spacings greater than 108"

- The Frame Capacity Chart gives allowable loads based on the specified "Unsupported Length" of the columns.
- Values shown are in full compliance with the current RMI Specifications.
- The loads on upright frames accumulate from top to bottom, therefore, the unsupported length and the column load below each beam level should be checked to determine the worst-case scenario.
- The capacities shown in this table are for static load conditions only.
- For other special conditions such as seismic or wind loadings, consult with Ridg-U-Rak sales.



Style 31I



Style 32I

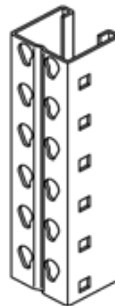

Style 33I

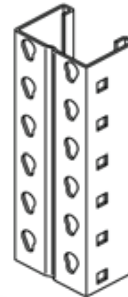

Style 43I



# Teardrop Beams

Interchangeable teardrop beams, as with slotted beams, are available in many profiles, in virtually any length, with capacities to 18,000 lbs. per pair. You can tie into many existing systems both old and new. Beams have a safety factor of 1.67 based on minimum yield of steel. All beam capacities are calculated based on the requirements of the current RMI specification.

Our teardrop pallet system provides a robust, patented, automatic lock for improved safety. The Springlock assembly provides positive beam-to-column engagement, improving installation speed and safety.

All capacities are based on uniformly distributed loads on a pair of beams. Other loading conditions can greatly reduce the carrying capacity of a beam. For unusual loading requirements, call your local Ridg-U-Rak distributor.

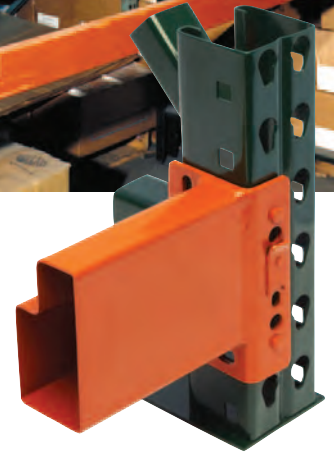
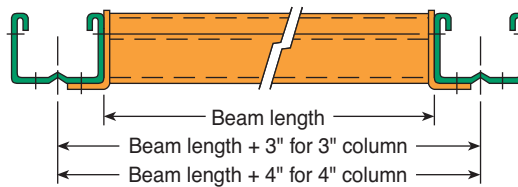

## Beam Capacities

Beam Profile	Beam Lengths										
	48"	60"	72"	84"	92"	96"	102"	108"	120"	144"	156"
250 S	5,700	4,530	3,130	2,300	1,910	1,750	1,550	1,380	1,120	770	660
300 S	7,500	5,980	4,820	3,530	2,940	2,690	2,380	2,120	1,720	1,190	1,010
355 S	9,760	7,770	6,460	5,330	4,440	4,070	3,600	3,210	2,590	1,790	1,520
410 L	10,810	8,620	7,150	6,110	5,570	5,200	4,600	4,100	3,310	2,290	1,940
410 S	12,000	9,780	8,120	6,930	6,320	5,830	5,160	4,600	3,710	2,570	2,180
465 S	12,000	11,970	9,940	8,490	7,740	7,410	6,960	6,320	5,110	3,530	3,000
500 S	12,000	12,000	11,170	9,540	8,700	8,330	7,830	7,380	6,140	4,250	3,610
550 S	18,000	18,000	18,000	11,150	10,160	9,720	9,140	8,620	7,740	5,420	4,610
600 S	18,000	18,000	18,000	12,850	11,710	11,210	10,540	9,940	8,920	6,790	5,770
650 S	18,000	18,000	18,000	14,660	13,360	12,790	12,020	11,340	10,180	8,360	7,110
650 R	18,000	18,000	18,000	18,000	15,160	14,520	13,640	12,870	11,550	9,370	7,970

- Capacities are based on uniformly distributed loads per pair of beams.
- Capacities listed are for non-seismic conditions. For seismic conditions consult with Ridg-U-Rak sales or engineering.
- Capacities listed are for a 2-pallet wide condition.
- All beams over 114" in length should utilize at least (1) flanged, tek-screwed or lock-in cross bar located at mid length.
- Maximum shelf load for Teardrop Beams using 6" connectors with 2-pins is 12,000# per pair.
- Maximum shelf load for Teardrop Beams using 8" connectors with 3-pins is 18,000# per pair.

### Beam Profile Dimensions

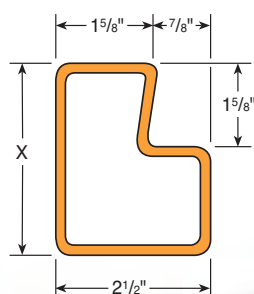

X
2.50
3.00
3.55
4.10
4.65
5.00
5.50
6.00
6.50



Enhanced robust automatic lock



# Structural *Frames & Beams*

## Slotted Connections

### Upright frames

- Upright frame capacities vary according to vertical beam spacing. See chart.
- Upright columns are hot-rolled structural channel with 50,000 psi minimum yield.
- Upright frames have a safety factor of 1.92 based on minimum yield of steel.
- Slotted beams are vertically adjustable on 4" centers.
- Standard colors:  
Uprights – forest green  
Beams – safety orange  
Other colors available on special order.
- Front column foot protector is optional.
- Heavy duty lower horizontal brace is optional.



### Frame capacity chart



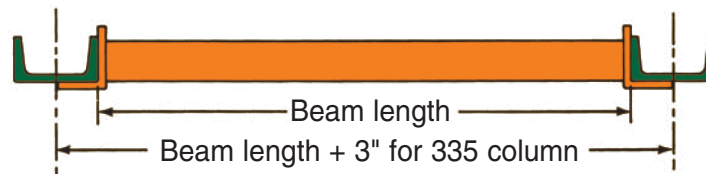

Vertical Beam Spacing	SSF-335
36"	34,200
48"	33,300
60"	30,000
72"	24,000
84"	18,400
96"	14,200
108"	11,300

### Beam length

column center line determination



### Beam capacities - Slotted Connection

Beam Length	335 		341 		445 		567 		682 	
	Un-braced Cap/pr	Braced Cap/pr	Un-braced Cap/pr	Braced Cap/pr	Un-braced Cap/pr	Braced Cap/pr	Un-braced Cap/pr	Braced Cap/pr	Un-braced Cap/pr	Braced Cap/pr
48"	10,880	11,160	12,290	12,290	18,510	18,910				
54"	9,350	9,920	10,640	10,930	15,860	16,810				
72"	6,280	7,210	7,330	7,930	10,550	12,610	18,810			
84"	4,970	5,300	5,830	5,830	8,060	10,810	14,840	18,960		
92"	4,140	4,420	4,860	4,860	6,650	9,870	12,330	17,310		
96"	3,800	4,060	4,460	4,460	6,080	9,320	11,280	16,590		
102"	3,360	3,600	3,950	3,950	5,350	8,260	9,940	15,620	14,130	
108"	2,990	3,210	3,530	3,530	4,750	7,370	8,830	14,750	12,520	
120"	2,420	2,600	2,860	2,860	3,820	5,970	7,100	12,880	10,030	
132"	2,000	2,150	2,360	2,360	3,140	4,930	5,840	10,640	8,220	17,640
144"	1,670	1,810	1,990	1,990	2,630	4,150	4,880	8,940	6,870	15,640
156"	1,430	1,540	1,690	1,690	2,230	3,530	4,150	7,620	5,820	13,330
180"	1,070	1,160	1,270	1,270	1,670	2,660	3,100	5,730	4,340	10,010

**Note:** Beams must be secured by beam locks against accidental upward forces.  
All capacities are per pair of beams based on uniformly distributed loads.  
Capacities are based on current RMI specifications.



# Structural *Frames & Beams*

## Bolted Connections

### Upright frames

- Upright frame capacities vary according to vertical beam spacing. See chart.
- Upright columns are hot-rolled structural channel with 50,000 psi minimum yield.
- Upright frames have a safety factor of 1.92 based on minimum yield of steel.
- Bolted beams are vertically adjustable on 2" centers.
- Standard colors:  
Uprights – forest green  
Beams – safety orange  
Other colors available on special order.
- Front column foot protector is optional.
- Heavy duty lower horizontal brace is optional.



### Frame capacity chart



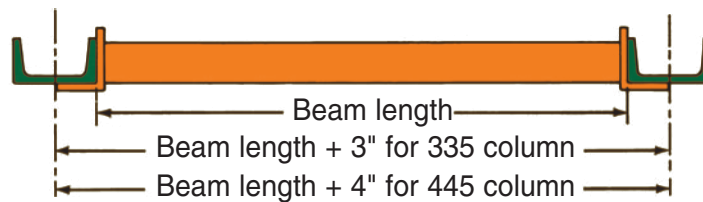

Vertical Beam Spacing	SBF-335	SBF-341	SBF-445
36"	34,200	40,300	51,600
48"	33,300	39,200	50,600
60"	30,000	35,000	50,000
72"	24,000	27,600	44,500
84"	18,400	21,000	38,600
96"	14,200	16,100	32,600
108"	11,300	12,800	26,800

### Beam length

column center line determination



### Beam capacities - Bolted Connection

Beam Length	335 		341 		445 		567 		682 	
	Un-braced Cap/pr	Braced Cap/pr	Un-braced Cap/pr	Braced Cap/pr	Un-braced Cap/pr	Braced Cap/pr	Un-braced Cap/pr	Braced Cap/pr	Un-braced Cap/pr	Braced Cap/pr
48"	10,880	11,160	12,290	12,290	18,510	18,910				
54"	9,350	9,920	10,640	10,930	15,860	16,810				
72"	6,280	7,210	7,330	7,930	10,550	12,610	18,810			
84"	4,970	5,300	5,830	5,830	8,060	10,810	14,840	18,960		
92"	4,140	4,420	4,860	4,860	6,650	9,870	12,330	17,310		
96"	3,800	4,060	4,460	4,460	6,080	9,320	11,280	16,590		
102"	3,360	3,600	3,950	3,950	5,350	8,260	9,940	15,620	14,130	
108"	2,990	3,210	3,530	3,530	4,750	7,370	8,830	14,750	12,520	
120"	2,420	2,600	2,860	2,860	3,820	5,970	7,100	12,880	10,030	
132"	2,000	2,150	2,360	2,360	3,140	4,930	5,840	10,640	8,220	17,640
144"	1,670	1,810	1,990	1,990	2,630	4,150	4,880	8,940	6,870	15,640
156"	1,430	1,540	1,690	1,690	2,230	3,530	4,150	7,620	5,820	13,330
180"	1,070	1,160	1,270	1,270	1,670	2,660	3,100	5,730	4,340	10,010

**Note:** All capacities are per pair of beams based on uniformly distributed loads. Capacities are based on current RMI specifications.

# Frame Options

Full Depth Base Channel

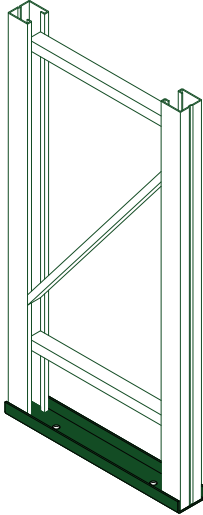

Welded Angle Deflector

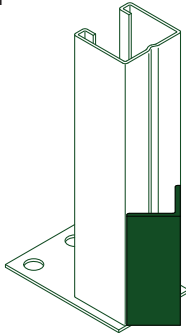

Floor Pad Options

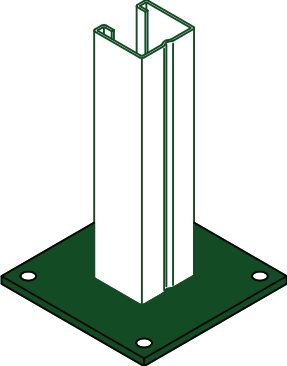
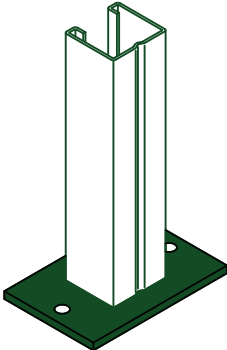
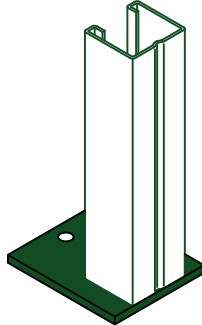

Single Heavy Duty Bottom Horizontal

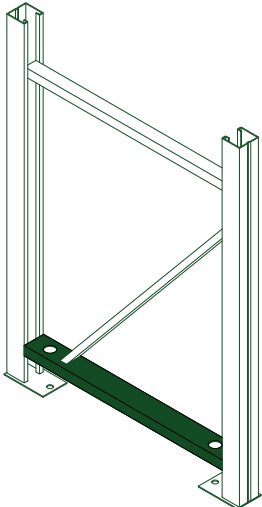

Welded Wrap-Around Deflector

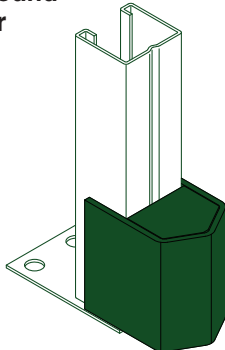

Welded Wrap-Around Deflector Front Anchor

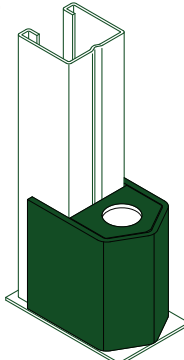

Double Heavy Duty Bottom Horizontal

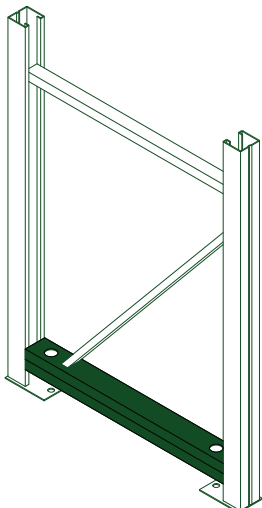

Welded Wrap-Around Deflector Front Anchor & Heavy Horizontal

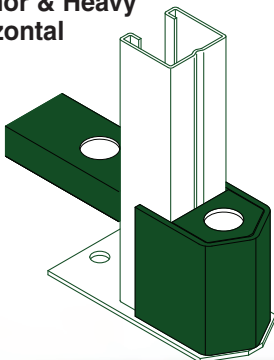

Slant-back Frames

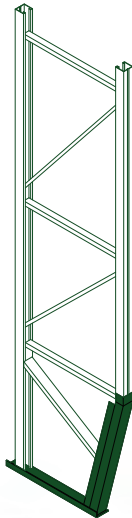

Offset Frames

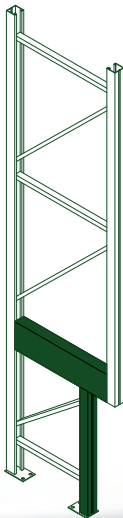

# Beam Options

**Bolted Beam Connection**

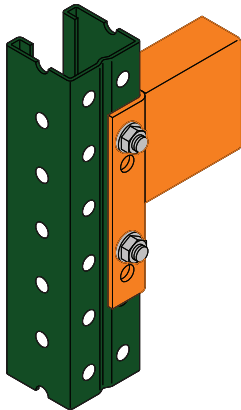

**Beam Step Punching**  
For "Tabbed" and "Drop-in" Cross Bars

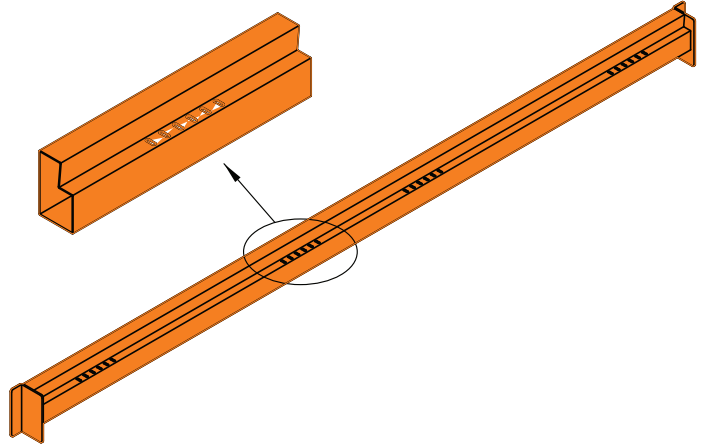

**Teardrop Beam Connection**

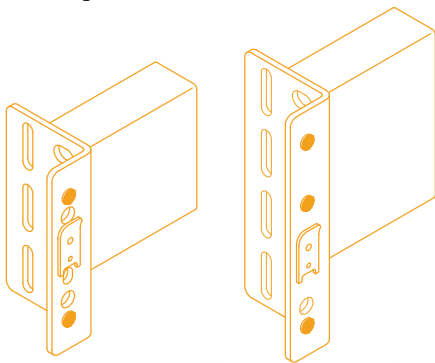

2 Pin

3 Pin

**Pallet Stops**  
Factory Welded to Beam

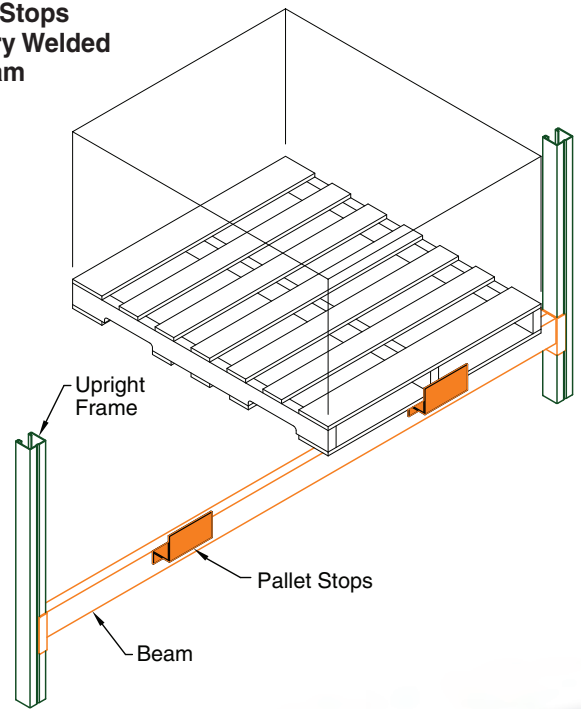

Slant-back Frame Option

# Column Sentry

## Rack Abuse

Accidental lift truck impact damage is inevitable, but unique Column Sentry reinforcing keeps it to an absolute minimum.

- Single Heavy 7 gage (3/16") Internal Channel
- One design with improved performance vs. previous design of CSI & II
- New Channel accomodates field drilled side holes and bolts as needed

Column Sentry reinforcing is heavy gage steel channel welded inside the column providing exceptional resistance to impact damage of frame columns. Column Sentry reinforcing helps guard against rack failure, collapse, and local buckling; at the same time, it increases column load carrying strength. And that's not all. Column Sentry reinforcing is compact, thereby, saving critical aisle space. No more space is required than our standard column, and it need be applied only in critical areas such as floor to first beam level on front columns (aisle side).

No other reinforcing method offers the protection, strength, and economy of Column Sentry.

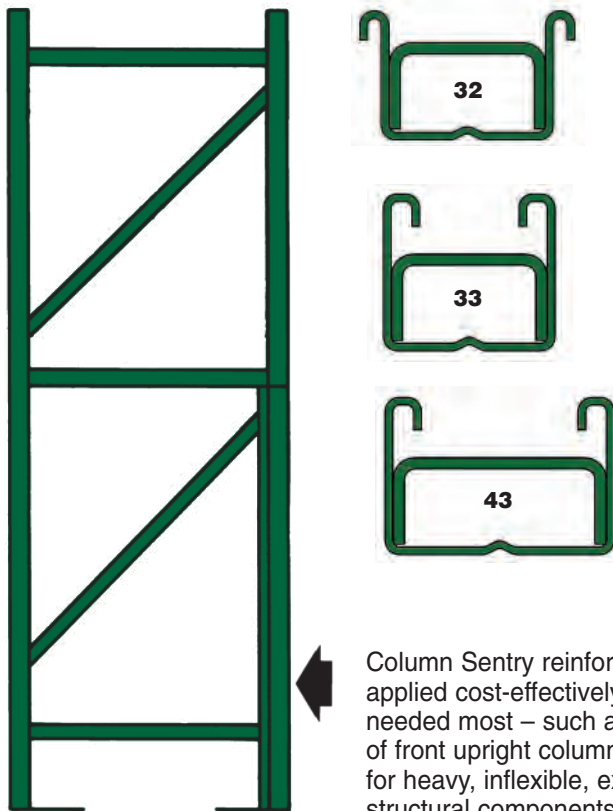

Column Sentry reinforcing can be applied cost-effectively where it's needed most – such as lower leg of front upright column. No need for heavy, inflexible, expensive structural components in areas where damage is unlikely to occur.



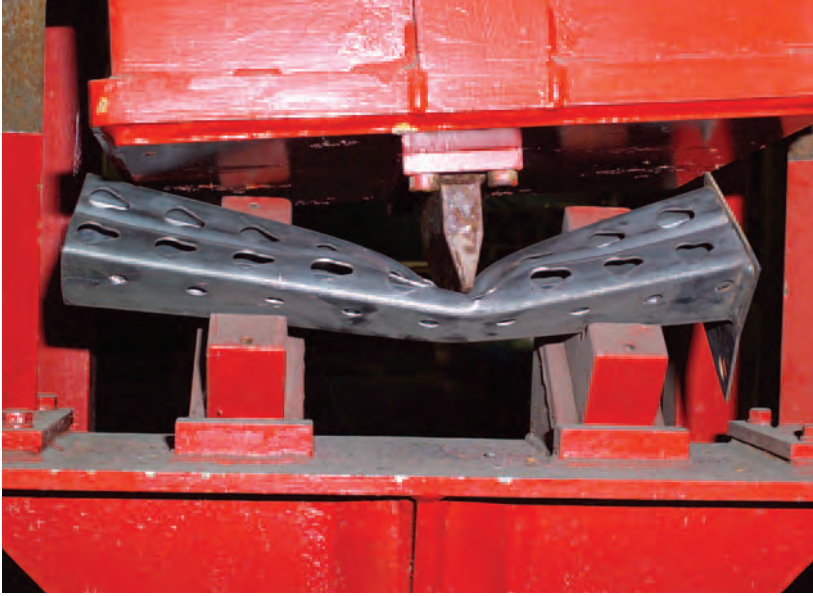

**Test of Unreinforced Columns**

## *Resistance to Impact*

Adding Ridg-U-Rak's Column Sentry reinforcing results in a composite column section that increases column strength by as much as 240%; as well as increasing torsional resistance several hundred times. This results in an upright frame that is extremely resilient, impact resistant, economical and most importantly, provides *tremendous residual carrying capacity after an impact occurs!*

### **Guillotine Impact Testing best simulates the impact of a lift-truck fork.**

Measuring *Impact Resistance* offers the most accurate assessment of how a column will respond when subjected to "typical abuse" in warehousing environments. Other tests, such as Load Tests, only measure the ability of a column as it relates to capacities.

### **Upright column strength comparison after equal impact**

Laboratory tests were conducted to determine the axial load carrying capability of different column sections after an equal impact load was applied. After impact, each column section was placed in a testing machine where controlled compressive force was applied. The deflection was measured and recorded at increasing load increments and then plotted logically.

**Note: See the Poor Impact Performance of the Tube Columns.**

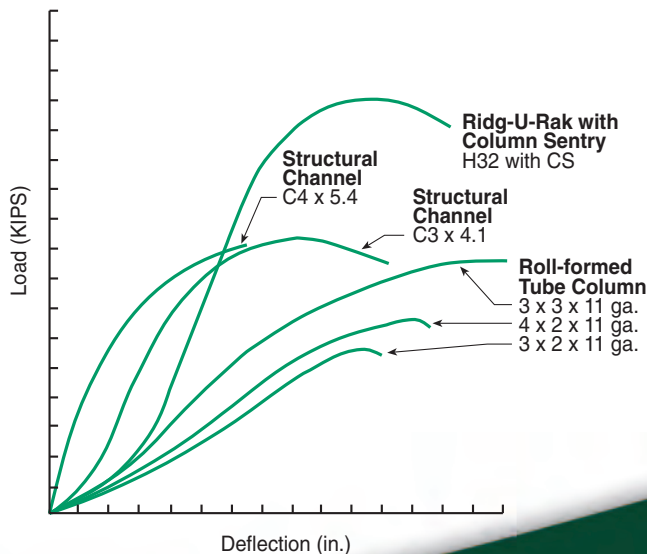

### **Column Sentry**

Column Sentry provides maximum protection against lift truck impact damage.

**Column Sentry**



# Accessories

## Slotted & Teardrop

**Row Spacer**

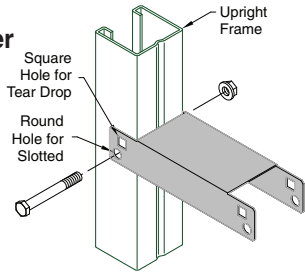

**Row-to-wall Spacer**

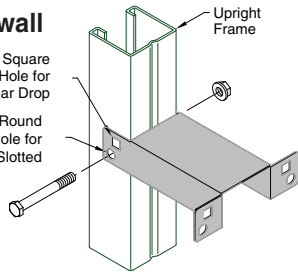

**Flanged Crossbar (CBF)**

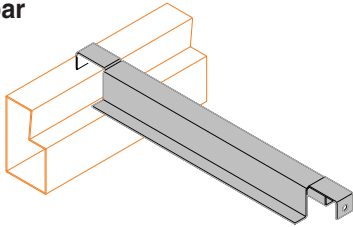

**Straight Crossbar (CBN)**

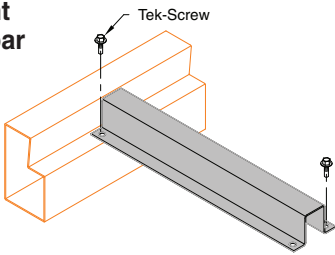

**Tabbed Crossbar (CBU)**

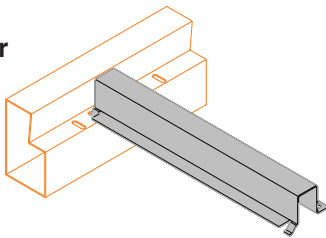

**Low Profile Drop In Crossbar (CBW)**

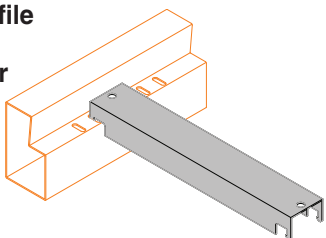

**Low Profile Straight Crossbar (CBL)**

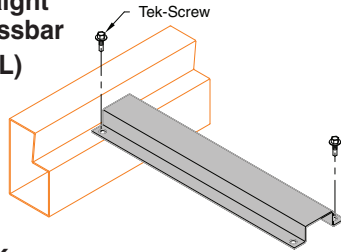

**Fork Entry**

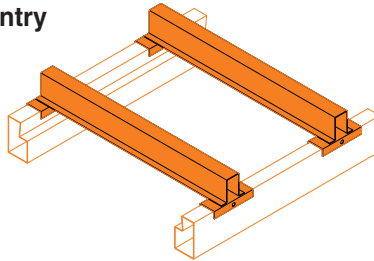

**Skid Rails**

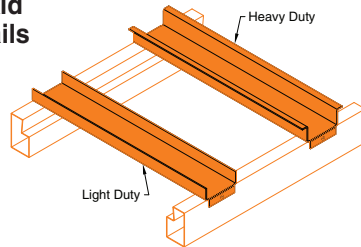

**Metal Deck**

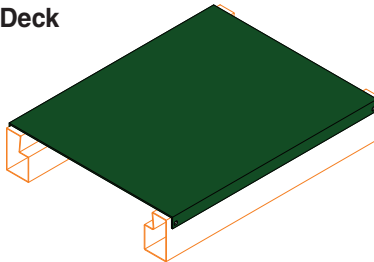

**Column Guards**

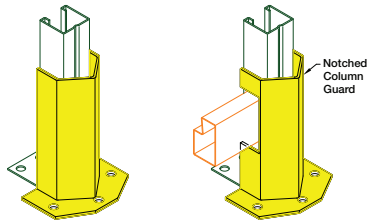

**Floor Mounted**

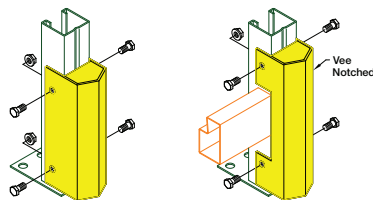

**Column Mounted**

**Catwalk Support**

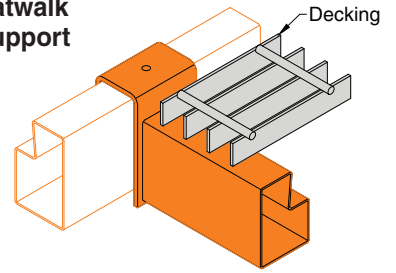

**Aisle Bridging**

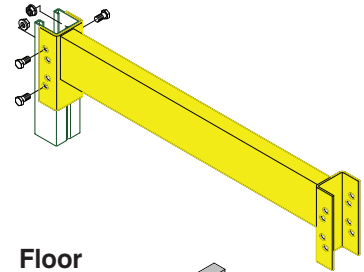

**Floor Shims**

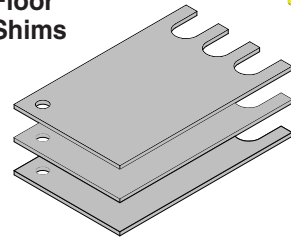

**Bolted Load Stops**

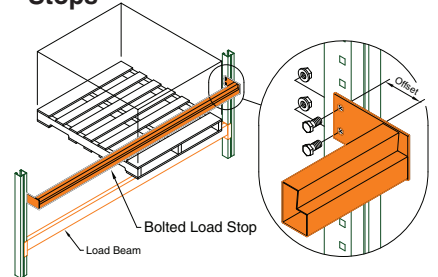

**Manual Locking Devices**

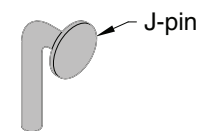
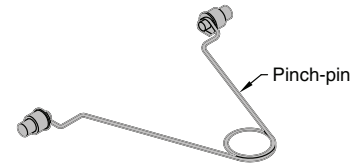

# Accessories

## Structural

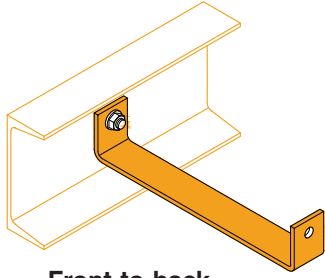

Front-to-back beam tie

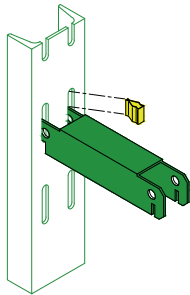

Slotted row spacer

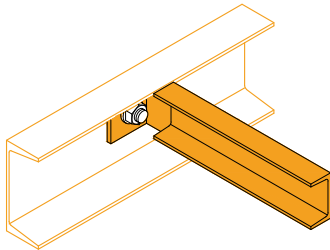

Structural channel pallet support

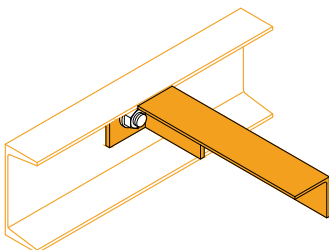

Structural angle pallet support

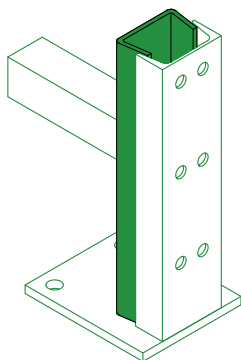

Reinforced upright column



Slotted beams

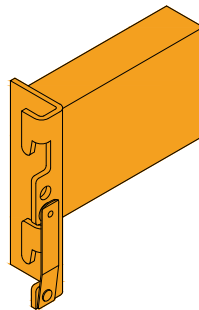

Bolted beams

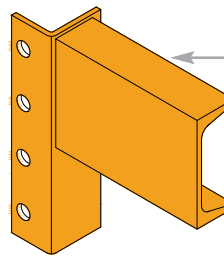

Standard

Standard beam position  
(Use part number designation - B)

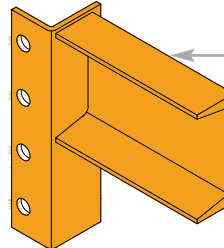
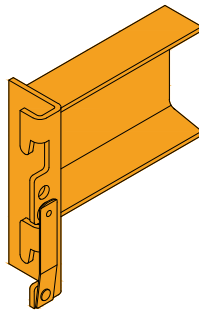

Alternate

Alternate beam position  
(Use part number designation - A)

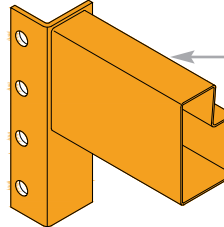
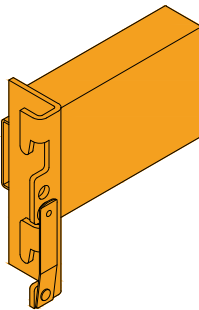

Roll-formed

Roll-formed beam also available  
for either connection style.

# Quality Manufacturing



**Roll Form Manufacturing**  
State-of-the-Art high volume roll form operation using induction welding process for closed tube beams.

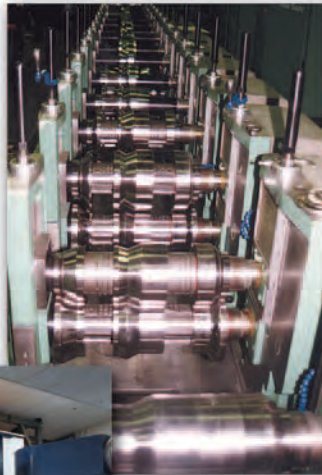

## AWS Certified Welders

The quality of the workmanship performed on a rack system directly relates to that rack's durability and safe usage. Ridg-U-Rak uses AWS certified welders to ensure the manufacturing of reliable products.

## State-of-the-Art Powder Coat Paint Systems

Racks built to last require a durable finish. Our powder coated paint finish has superior impact resistance and is applied by our state-of-the-art automated paint line for uniform quality. Additionally, hard-to-access areas are hand sprayed to ensure coverage. Ridg-U-Rak systems resist chips and scratches, providing a long-lasting finish for better appearance and reduced maintenance.

## Certified Fabrication

Through an audit and approval process of our quality system, Ridg-U-Rak is a licensed and certified manufacturer in a number of municipalities around the United States.



RIDG-U-RAK is a founding member in good standing of RMI. The Storage Rack covered by this manual is in full compliance with the latest design specification approved by the members of the RACK MANUFACTURERS INSTITUTE. We believe that it is important to you that your supplier be committed to the principles of continuous improvement in both product design/application, and in the highest professional and ethical standards of performance as embodied in the mission and work conducted within RMI.

**Proud member of these organizations:**



*Famous for integrity for over 75 years*